



# AlphaScan 5900

Powered by JRC

# Choose your display

The new AlphaScan 5900 can be connected to the AlphaScreen 19-inch and 26-inch proprietary displays. Both displays are completely new following the latest standards and are developed in line with minimalistic design approach.

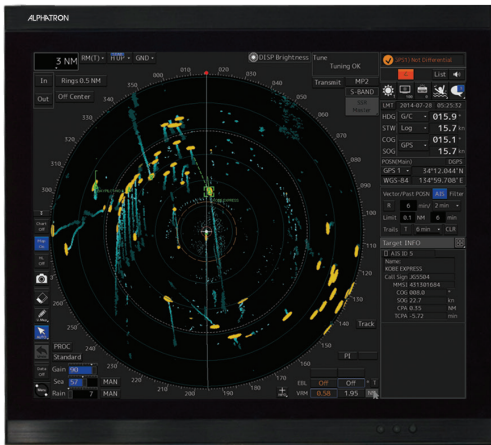

Size	Pixels	Resolution	Aspect ratio	IMO category	Vessel size
19-inch	1280 by 1024	SXGA	5:4	CAT2 radar 250mm	300-9999GT
26-inch	1920 by 1200	WUXGA	16:10	CAT2 radar 250mm	300-9999GT

## Trackball, as minimum

A smart multi button found on the operating unit allows the operator to “turn and press” to access various functions such as zoom, display and brightness and track color. The function selected at that point is shown at the top center on the display.



## Keyboard

The newly designed full-size QWERTY keyboard (option) is just as comfortable to type on as a desktop keyboard. Response feel keys allow logical and precise operation while backlighting allows typing in low-light conditions with ease. One touch access to EBL, VRM, RAIN, SEA and GAIN is available from the keyboard with dedicated (analog) push and rotate buttons.

# Central control unit

The Central Control Unit (CCU) can be used for your basic interfacing and configuration. A wide range of standard interfacing is directly available from this unit. The CCU includes two in-house designed Blizzard™ processors, bringing operational performance to a whole new level, especially for the complex tasks running flawlessly in the foreground and the background. Ready for years ahead.

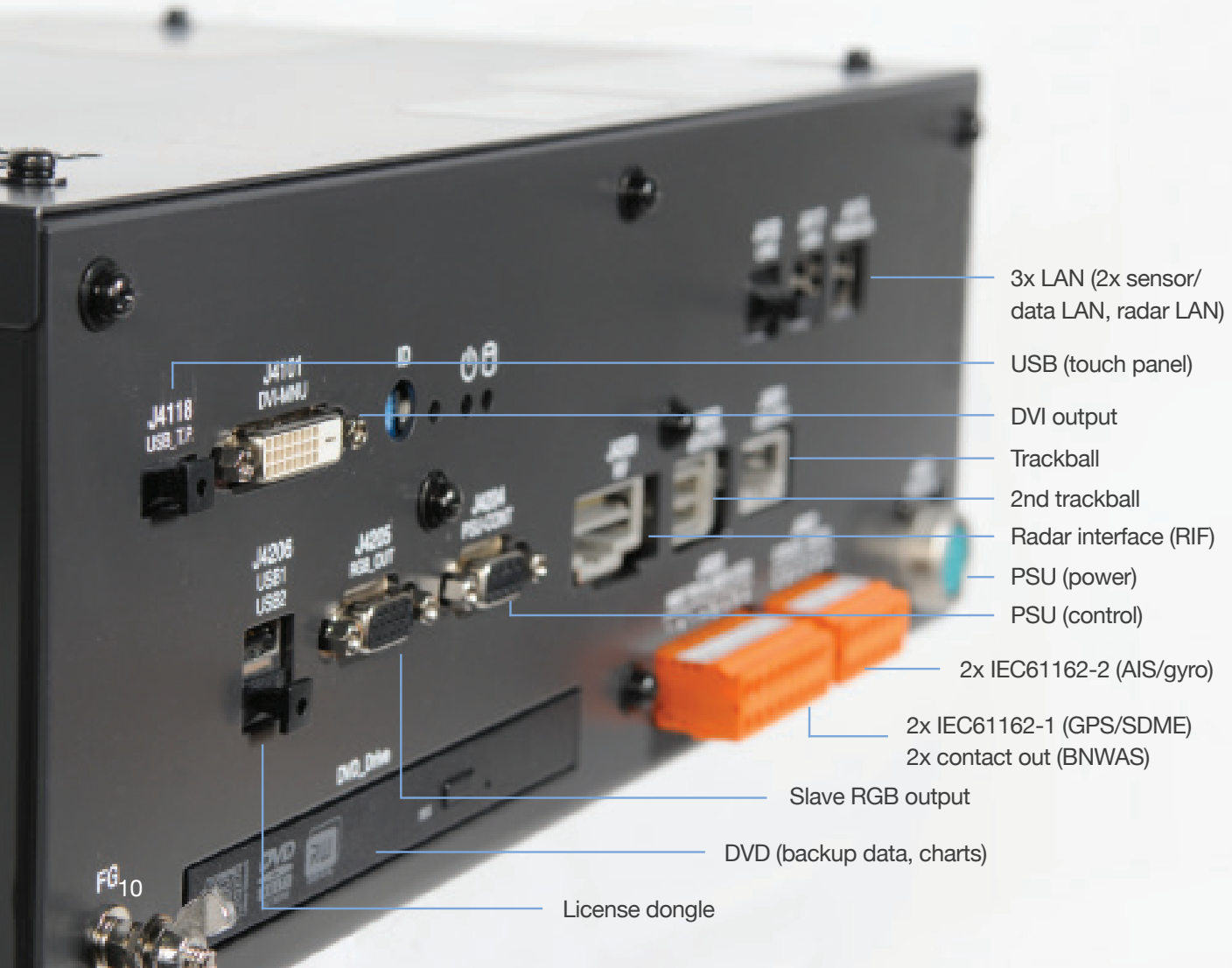

# Junction box

The AlphaScan 5900 includes the junction box and Radar Interface (RIF) as standard. Extending your system by extending the number of interfaces and ports can be done the moment you purchase your system or can be upgraded while at sea. Either way, the junction box with the ability to hold a variety of boards plays a central part.

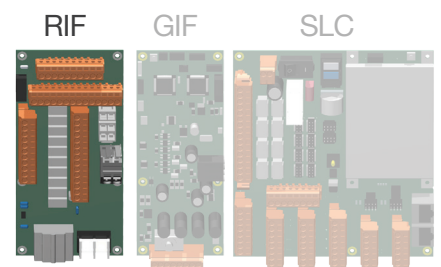

# Advanced processing

The AlphaScan 5900 includes the powerful Blizzard™ processor that features advanced signal processing and graphic drawings, regardless of which display you are using it delivers unprecedented performance - all around. So whether you are browsing through your alarm list, tracking 100+ ARPA and/or AIS targets, the AlphaScan 5900 with its Blizzard™ processing flies through the most complex tasks with incredible power and speed.

## *TT in the background*

If you want to track a target, you will get a stable vector immediately. That is because that the detected target was already being tracked in the background. This applies for up to 100 potential targets tracked in the background up to as far as 32NM, in "near to far" order. Blizzard™ is always assisting you, even though you do not need it at that moment.

## *Radar in the background*

The enormous processing capability of Blizzard™ allows superfast display of the radar picture, even outside the PPI. One range up and down from the range you currently have on display is being processed in the background, allowing for immediate response and display when range is changed. Seeing is believing.

## *Tracking zoom outside PPI*

While being in shipping lanes or on busy open waters, it could happen that the target you are tracking is outside your visible area. Blizzard™ continues to track these targets many nautical miles outside the circle. Simply select a starting point and drag the cursor outside the PPI to track zoom on a separate window. And the tracking zoom continues to follow the target until you close the window.

# Scanners

The AlphaScan 5900 includes a wide range of scanners. X-band offers greater resolution and detection of smaller targets, but is subject to interference from rain and seas. S-band radar has a longer range and less interference from rain and sea clutter, but has less sensitivity for small targets. Available as a traditional magnetron type or solid state (S-band), low maintenance scanners, various scanner lengths and output power, normal or high speed, many variations are possible, to always have a solution at hand to fit your type of vessel. New in this radar series are the second generation Solid State S-band scanners, available in normal and high speed. This much more air shippable scanner it is smaller and lighter than the original 12ft scanner.



# In the box

System consisting of	NCM-928R	Scanner	NKE-xxxx
- Central Control Unit	- NDC-1590	Junction box	NQE-1143
- Trackball	- NCE-5605	Radar interface	CQD-2273
- Power supply	- NBD-913	Cables + Manual	

# Options

19-inch display	AlphaScreen 19	Sensor LAN switch	NQA-2443
26-inch display	AlphaScreen 26	Interswitch 4-ch	NQE-3141-4
19-inch display	NWZ-207	Interswitch 8-ch	NQE-3141-8
26-inch display	NWZ-208	Power Control Unit (PCU)	NQE-3167
Power supply	NBA-5111	Desktop frame for NWZ-207	CWB-1594
Keyboard	NCE-5625	Desktop frame for NWZ-208	CWB-1595
Serial to LAN convertor	CMH-2370	Operation desktop frame	CWB-1596
Gyro interface	CMJ-554	Tray	CWB-1593

# Tech Specs

## Trackball RoHS

NCE-5605 Weight 1.3 kg



- 2-inch trackball
- 2 buttons click (left and right)
- USB and speaker
- Vibration of alert and warning
- Multi function button
- Cable up to 5 m (option 30 m)
- System ON/OFF button

## Central Control Unit (CCU) RoHS

NDC-1590 Weight 5.6 kg



- 1x DVI-D, 1x VGA
- 2x IEC61162-1, 2x IEC61162-2
- 3x LAN, 2x dry contact,
- 1x trackball, 1x serial operation
- 1x power, 3x USB
- 1x RIF, 1x DVD drive
- 1x ground

# Tech Specs

## Power Supply Unit (PSU) RoHS

NBD-913 Weight 4.2 kg



AC input 85 to 264V AC  
DC input 21.6 to 31.2V DC  
Over voltage protection  
DC output 12V, 2A (standby)  
DC output 24V, 4A (CCU)  
DC output 24V, 6A (display)  
DC output 48V, 4A (scanner)

## Junction box RoHS

NQE-1143 Weight 3.8 kg

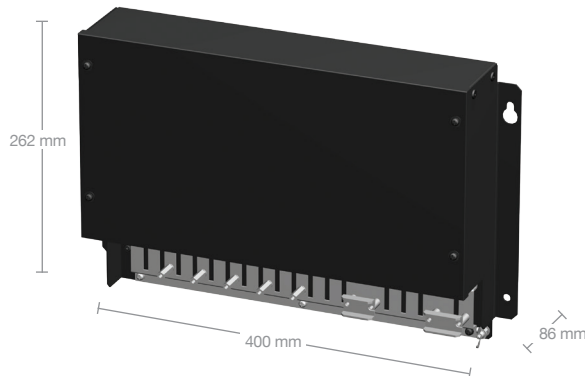

Power 21.6 to 31.2V DC  
Power consumption 48VA (max)  
Current protection 3Ax2 15Ax1  
Reverse polarity protection  
Temperature: -15° to 55°C  
Protection rate: IP20  
Humidity: ≤93% noncondensing

## Radar interface RoHS

CQD-2273 Weight 50 g

1x scanner input  
1x slave video output  
Radar video 0 to 2.6V DC, 50Ω, log scale 50dB/V  
Trigger positive, 4V, 1μs, 50Ω  
Bearing pulse (BP) 2048 pulse/round  
Bearing zero (BZ) 1 pulse/round

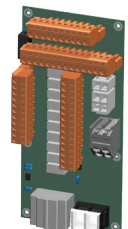

# Tech Specs

10kW X-band RoHS

NKE-2103-6 Weight 40 kg



10kW X-band high speed RoHS

NKE-2103-6HS Weight 40 kg

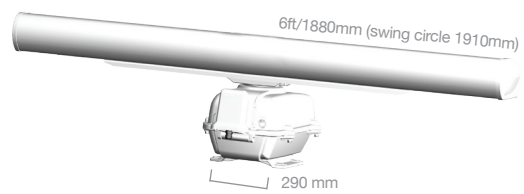

25kW X-band high speed RoHS

NKE-2254-6HS Weight 55 kg

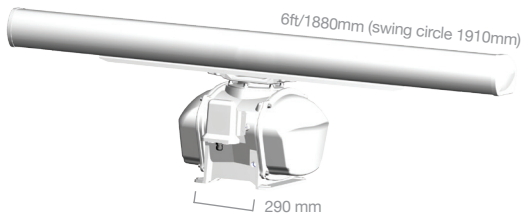

25kW X-band RoHS

NKE-1125-6 Weight 55 kg



25kW X-band RoHS

NKE-1125-9 Weight 60 kg

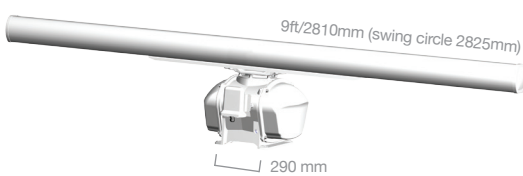

30kW S-band RoHS

NKE-1130 Weight 180 kg



250W S-band solid state RoHS

NKE-2632 Weight 85 kg

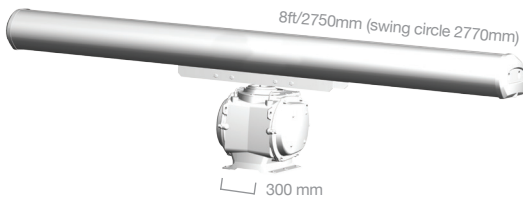

250W S-band solid state high speed RoHS

NKE-2632-H Weight 90 kg

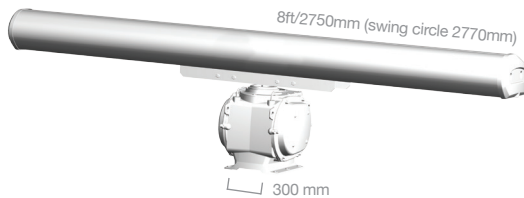

250W S-band solid state RoHS

NKE-1632 Weight 160 kg

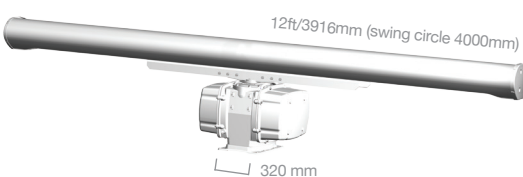

alphatronmarine.com

## Offices

Belgium, Curaçao, Germany, The Netherlands, Poland, Singapore, Spain, USA