

NWZ-4610

MULTI INFORMATION DISPLAY

INSTRUCTION
MANUAL

General Information

Thank you for purchasing the Japan Radio Co., Ltd. NWZ-4610 Multi Information Display (MID). This equipment receives NMEA data from various sensors for display.

- Before attempting to operate this equipment, read this instruction manual thoroughly to ensure correct and safe operation in accordance with the warning instructions and operation procedures.
- You are strongly recommended to store this instruction manual carefully for future reference. In the event that you have an operational problem or malfunction, this manual will provide useful instructions.

Before You Begin

Symbols Used In This Manual

In this manual, and on the equipment, we use several warning signs to call your attention to important items that, if not handled correctly, could present danger to yourself or property. These warning note classifications are as described below.

Please be fully aware of the importance of these items before using this manual.



WARNING

Indicates warning items that, if ignored, may result in serious personal injury or even death.



CAUTION

Indicates cautionary items that, if ignored, may result in personal injury or physical damage.

Examples of Related Symbol Marks Used in this Manual and on the Unit



Each \triangle mark is intended to alert the user to the presence of precautions including danger and warning items. The picture in each \triangle mark (“Electric shock” in the example on the left.) alerts you to operations that should be carefully performed.



Each \circ mark is intended to alert the user to the presence of prohibited activity. The picture/word in/beside each mark (“Disassembling Prohibited” in the example on the left.) alerts you to operations that are prohibited.



Each \bullet mark is intended to alert the user to the presence of necessary instructions. The picture in each \bullet mark (“Disconnect the power plug” in the example on the left.) alerts you to operations that must be performed.











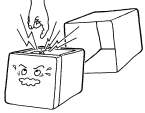

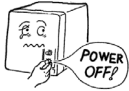





WARNING LABEL

You can see the warning label on the top of the unit.





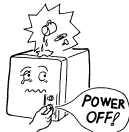

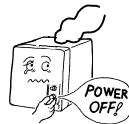





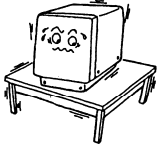

Do not attempt to remove the warning label from the unit or impair or modify it.

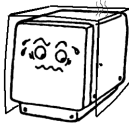
Usage Hints

⚠ WARNING

	Do not remove the cover of this unit. Otherwise, you may touch a high-voltage part and suffer from an electric shock.	
	Turn off the power on/off switch, and turn off the power supply breaker when you for maintenance check this unit for maintenance. Otherwise, a fire, an electric shock, or a failure may occur.	
	Do not disassemble or modify this unit. Otherwise, a fire, an electric shock, or a failure may occur.	
	Do not place a vessel containing water, etc. or a metallic object on this unit. When water spills or when water or the object enters the unit, a fire, an electric shock, or a failure may occur.	
	Do not use this unit at a voltage other than the supply voltage stated on the unit. Otherwise, a fire, an electric shock, or a failure may occur.	
	Do not insert or remove the power cord or operate switches with a wet hand. Otherwise, you may suffer from an electric shock.	
	Do not damage or modify the power cord. Placing a heavy object onto, heating, stretching or bending the cord may cause a fire or an electric shock.	
	Do not check or repair in this unit. Please call our field representative or your nearest JRC office for inspection and repair services. Otherwise It may cause a fire or an electric shock.	
	In the event that you spill or drop any liquids or metals etc., turn off the unit, turn off the power supply breaker, and contact your sales agent outlet or one of JRC branch offices, sales centers or liaison offices. Otherwise continuing operation may cause a fire, an electric shock or a malfunction.	
	In the event that smoking or burning odors are detected, immediately terminate operation of the unit and contact your sales agent outlet or one of JRC branch offices, sales centers or liaison offices. Never attempt to check or repair the interior of the unit. Otherwise continuing operation may cause a fire or an electric shock.	

CAUTION

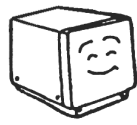
	Without qualified service personnel, do not attempt to install this unit. Contact our service center or agent for any electrical work or installation of this unit. Otherwise it may cause a malfunction.	
	Do not install this unit at the place exposed to direct sunlight for a long time or hit by hot wind or where the temperature rises above 55°C. Otherwise it may cause a fire or a breakdown.	
	Do not place the unit on a wobbly stand or any unsteady foundation. Otherwise it may cause the unit to fall, resulting in an injury or a damage.	
	Do not put this unit in the cabinet, and do not cover with the nonporous thing such as cardboard. Heat shuts oneself up, and it may cause a fire or a breakdown.	
	When this unit is suddenly moved from a cool place to a warm place, dew condensation water may form on the inside windows, and the liquid crystal part can become visually difficult. In this case, leave the unit for a while until becoming dry condition. Then operate the unit.	
	When installing this set, be sure to connect the grounding wire or the grounding plate to the grounding terminal of the unit. Otherwise you may suffer from an electric shock.	
	Do not turn on the power switch of the unit while the ship is on the shore. Otherwise, the transducer may malfunction.	
	Do not use an organic solvent such as thinner or benzine when you clean the surface of the unit. For cleaning the surface, remove the dust and wipe with clean dry cloth. Otherwise, the painting on the surface may be damaged	

External View



Contents

General Information	i
Before You Begin	ii
Usage Hints	iii
External View	v
Chapter 1 Introduction	1-1
1.1. Function	1-1
1.2. Features	1-2
1.3. Components	1-3
1.3.1. Standard equipment.....	1-3
1.3.2. Options.....	1-3
1.4. Construction	1-4
1.5. System Configuration	1-5
Chapter 2 Names and Functions of the Components	2-1
Chapter 3 Display Screen	3-1
3.1. Display Screen	3-1
Chapter 4 Operation	4-1
4.1. Menu	4-2
4.2. Basic Operation	4-9
4.2.1. Turning on the power	4-9
4.2.2. Starting (Normal).....	4-9
4.2.3. Starting (Abnormal).....	4-10
4.2.4. Starting (Abnormal).....	4-10
4.2.5. Turning off the power	4-10
4.2.6. Adjusting the back light (lighting) by using the key.....	4-11
4.2.7. Adjusting contrast	4-11
4.2.8. Turning off the alarm buzzer	4-11
4.2.9. Switching display	4-11
4.2.10. Alarm display	4-11
4.2.11. Selecting items from the menus	4-12
4.2.12. Entering a numeric value	4-13
4.3. User Mode Change	4-14
4.4. User Setting Screen Display	4-14
4.5. Setting Display	4-15
4.5.1. Adjusting contrast	4-15
4.5.2. Adjusting back light.....	4-16
4.5.3. Setting a click sound.....	4-16
4.5.4. Setting a display screen.....	4-16
4.5.5. Selecting a back light color.....	4-22
4.5.6. Setting graph scale	4-23
4.5.7. Registering user display	4-23
4.5.8. Resetting a TRIP	4-23
4.6. System Settings	4-24
4.6.1. Selecting units	4-24
4.6.2. Setting the time difference	4-25
4.6.3. Setting date display format	4-26
4.6.4. Setting Magnetic Correction	4-26
4.6.5. Displaying as loran c time difference	4-27
4.6.6. Setting transducer position of depth sounder (exclusive to JFE-380/680).....	4-27
4.6.7. Setting water depth offset of depth sounder.....	4-28
4.7. Language Settings	4-29
4.8. Alarm Settings	4-29
4.8.1. Setting the alarm range	4-30
4.8.2. Setting a system alarm	4-30
4.8.3. Setting a vessel speed alarm	4-31
4.8.4. Setting a TRIP alarm	4-31
4.8.5. Setting a ARRIVAL alarm.....	4-31
4.8.6. Setting the water temperature alarm	4-32
4.8.7. Setting the water depth alarm.....	4-32
4.8.8. Setting the wind velocity alarm	4-32
4.8.9. Setting the air temperature alarm	4-33
4.8.10. Setting the atmosphere alarm	4-33

4.8.11.	Setting the humidity alarm	4-33
4.8.12.	Setting a buzzer sound and screen back light.....	4-34
4.9.	Beacon Information.....	4-35
4.10.	Setting Installation	4-36
4.10.1.	Changing to a maintenance mode.....	4-36
4.10.2.	Setting a model.....	4-37
4.10.3.	Selecting a dimmer unit	4-37
4.10.4.	Dimmer linked control and data sharing with RS-485	4-38
4.10.5.	Setting a serial port.....	4-41
4.10.6.	Setting a contact port.....	4-45
4.10.7.	Outputting alarm history.....	4-46
4.10.8.	Checking installation.....	4-46
4.10.9.	Checking the input port.....	4-47
4.10.10.	Self-diagnosis	4-47
4.10.11.	Displaying an alarm	4-48
4.10.12.	Displaying the software version	4-49
4.10.13.	Performing master reset	4-49
4.10.14.	Demonstration.....	4-50
4.10.15.	Outputting setting value	4-50
4.10.16.	Setting the current to be displayed	4-50
4.11.	Setting daisy chain.....	4-51
Chapter 5	Maintenance	5-1
5.1.	Daily Maintenance	5-2
5.2.	Alarm	5-3
5.3.	Troubleshooting for Malfunctions or Abnormalities	5-4
5.4.	Repair Unit	5-5
5.4.1.	Repair unit.....	5-5
5.4.2.	Regular Replacement Parts.....	5-5
Chapter 6	Installation	6-1
6.1.	Affixing Display Unit Nameplate Labels	6-2
6.1.1.	Affixing product nameplate	6-2
6.1.2.	Affixing model identification plate	6-2
6.2.	Display Unit Installation.....	6-3
6.2.1.	Selecting the position for installation	6-3
6.2.2.	Mounting the display unit using a rack	6-4
6.2.3.	Mounting using a flash mount.....	6-6
6.2.4.	Removing the display unit by flash mounting	6-8
6.3.	Cable Connection	6-9
6.3.1.	DC12/24V DATA connector	6-10
6.3.2.	DATA1 connector.....	6-13
6.3.3.	SENSOR/DATA2 connector.....	6-17
6.4.	Optional Peripheral Connection	6-21
6.4.1.	Dimmer unit connection	6-21
Chapter 7	After-Sales Service	7-1
7.1.	When Ordering a Repair	7-1
7.2.	Recommendation of Overhaul	7-1
Chapter 8	Disposal	8-1
8.1.	Disposal of the Equipment.....	8-1
Chapter 9	Specifications.....	9-1
Appendix	Appendix-1
Appendix 1	Outline and Setting Drawing.....	Appendix-1
Appendix 2	Default value.....	Appendix-3
Appendix 3	Setting value memo.....	Appendix-7

Chapter 1 Introduction

1.1. Function

The Multi Information Display (MID) is the display unit that receives NMEA data items from various sensors to display them.

The screen can be split to up to 4 areas for use. Only necessary information can be displayed by selecting data to be displayed in the areas.

There are three modes in which six screens can be registered, and up to 18 screens can be registered.

1.2. Features

NWZ-4610 Multi Information Display (MID) has the following features:

- 1) Display of various NMEA data items
- 2) Selection of display contents and screen layout
- 3) Distribution of power supply in daisy chain mode
- 4) Selection of display screen in each mode
- 5) Sharing of data and interlocking of dimmer between display units at RS-485 interface

1.3. Components

The standard equipment and options are shown in the tables below.

1.3.1. Standard equipment

No.	Description	Model No.	CODE	QTY	Remarks
1.1	DISPLAY	NWZ-4610	NWZ-4610	1	Main Body
1.2	DATA POWER CABLE	CFQ-5766A	CFQ5766A	1	14 cores 2 m/ With Fuse holder data, power, contact
1.3	FUSE	MF60NR 250V 1	5ZFGD00205	2	Display unit 1A fuse
1.4	FRONT PANEL	MTV305018A	MTV305018A	1	
1.5	BASE KITS	MPBX47065	MPBX47065	1	Base Knob Bolt Gear Washer Knob Washer
1.6	MODEL IDENTIFICATION PLATE	MPNN47524A	MPNN47524A	1	For Rear
1.7	PRODUCT NAMEPLATE	MPNN47529A	MPNN47529A	1	For Front
1.8	Flush Mounting Drawing	-	-	1	For Flush Mount
2	QUICK REFERENCE	7ZPNA4352	7ZPNA4352	1	English/Japanese

1.3.2. Options

No.	Description	Model No.	CODE	QTY	Remarks
1	AC POWER RECTIFIER	NBD-577C	NBD-577C	1	AC100/220V input 24V output
2	DATA POWER CABLE	CFQ-5766D	CFQ5766D	1	14 cores 10 m/ With Fuse holder data, power, contact
		CFQ-5766F	CFQ5766F	1	14 cores 20 m/ With Fuse holder data, power, contact
3	DATA CABLE	CFQ-5767	CFQ5767	1	4 cores/3 m data 6-pin connector data line only
4	DATA CABLE	CFQ-5768	CFQ5768	1	6 cores-14 cores/3 m daisy chain
5	DATA CABLE	CFQ-5769	CFQ5769	1	For RS-485 4 cores/3 m
6	T-SHAPED CONNECTOR	AA-040404-MMM-TL	5JCDX00071	1	For CFQ-5769 RS-485
7	JUNCTION BOX	CQD-10	CQD-10C	1	16 terminals
8	DIMMER UNIT	NCM-227	NCM-227	1	External dimmer unit
9	L-TYPE ADAPTER	CFQ-9184	CFQ9184	1	
10	INSTRUCTION MANUAL	7ZPNA4284	7ZPNA4284	1	English
		7ZPNA4283	7ZPNA4283	1	Japanese

1.4. Construction

- **Display NWZ-4610**

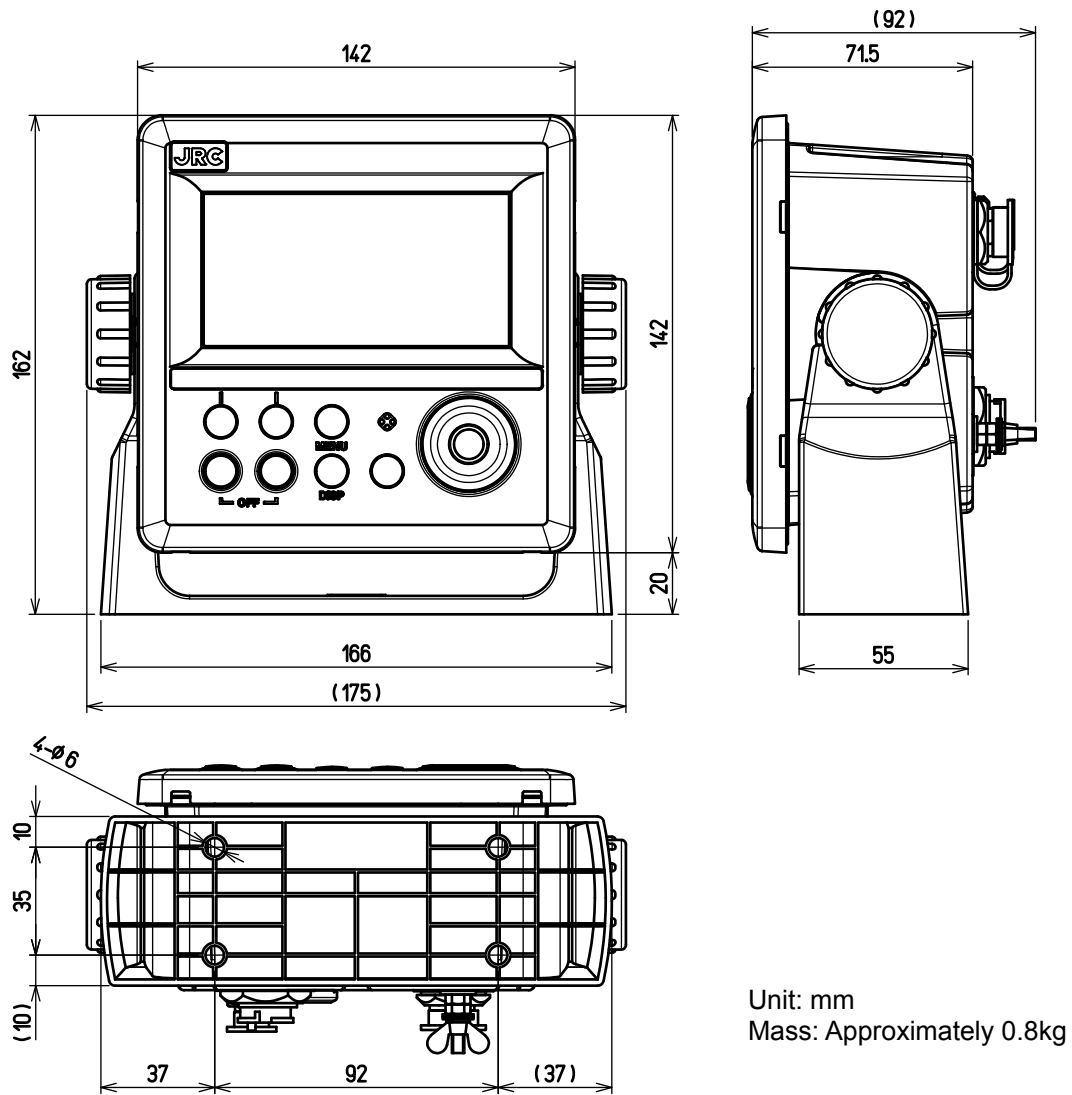
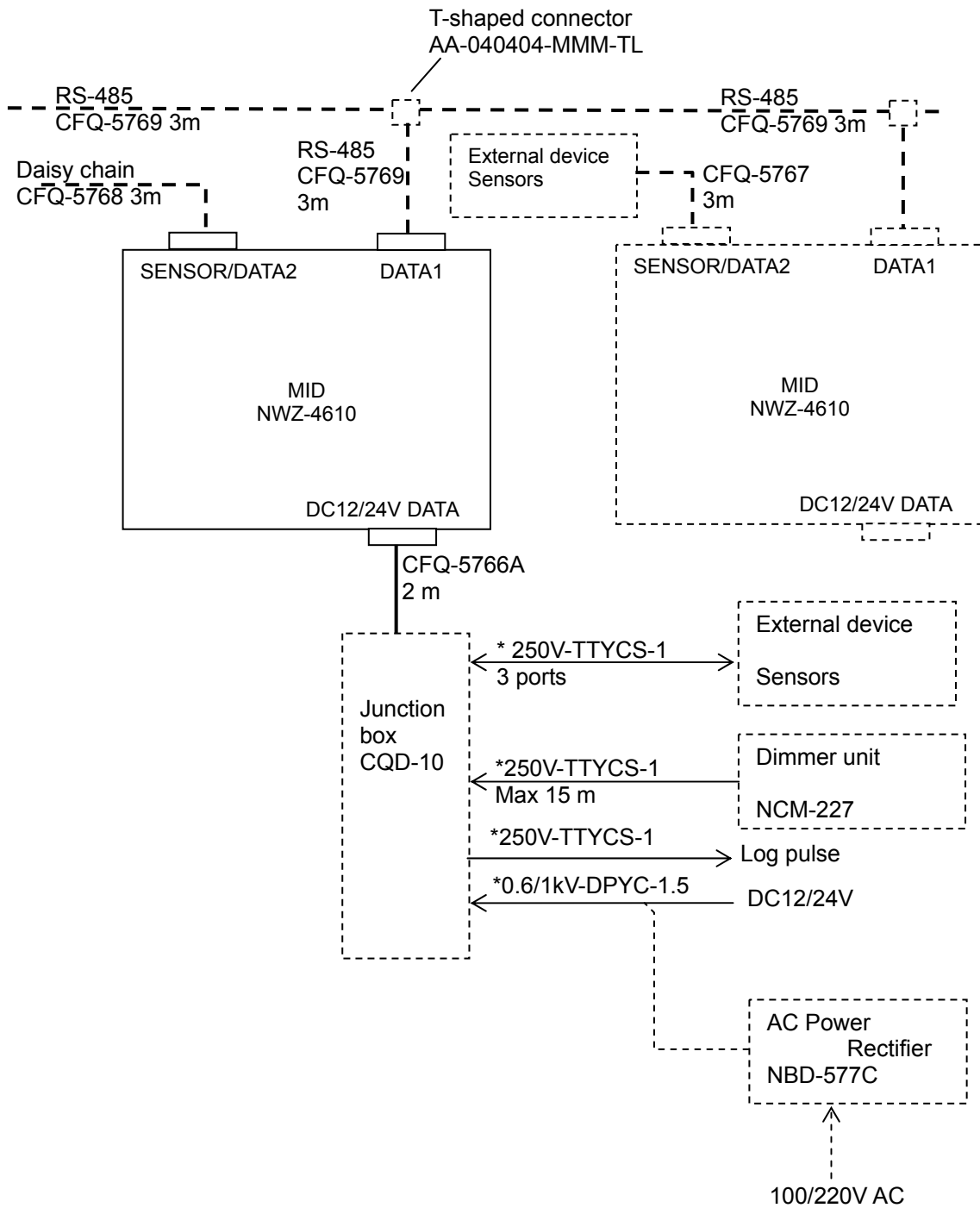

Figure 1.2 NWZ-4610 OUT LINE (Disk Form type)

1.5. System Configuration



*: Arranged by dockyard.

Chapter 2 Names and Functions of the Components

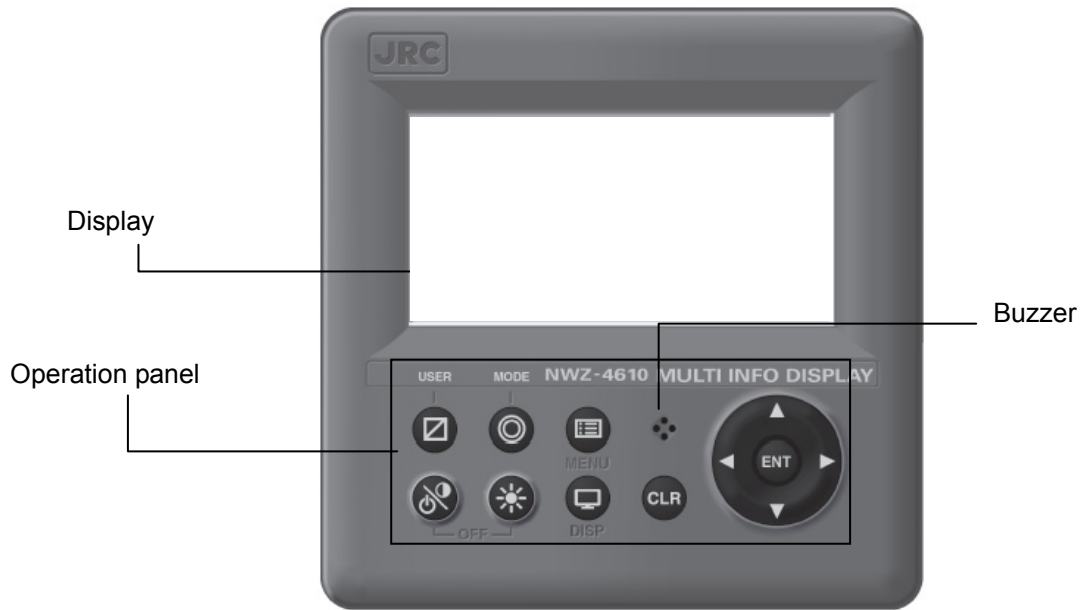
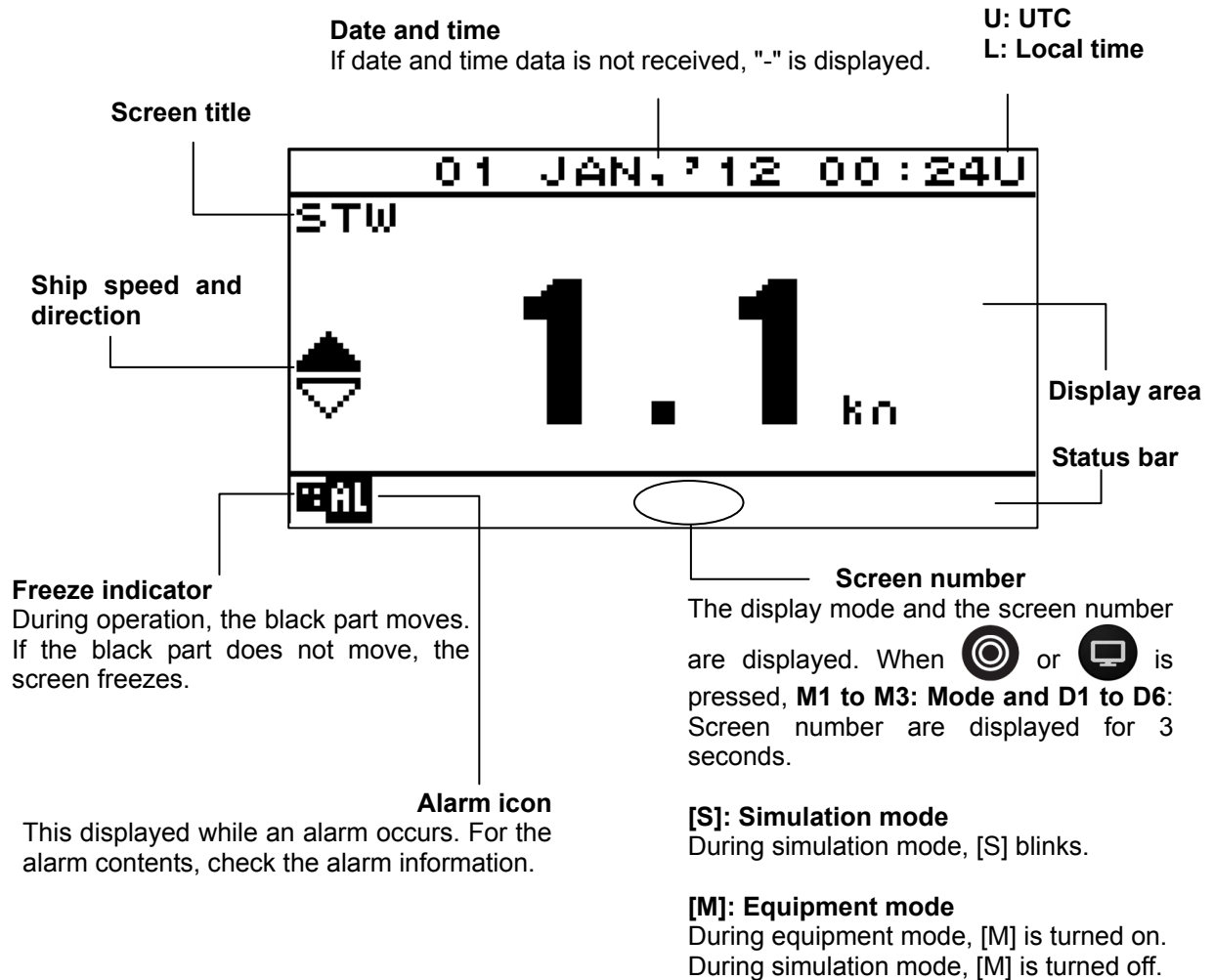

Figure 2.1 Operation panel of main display unit

No.	Keys	Name	Functions
1		Power/ Contrast key	Turns on the power. This key also adjusts the screen contrast. The power is turned off when the key and this key are pressed at the same time.
2		Dimmer key	Adjusts the brightness.
3		Menu key	Displays the main menu.
4		Display key	Changes the display screen.
5		Clear key	Cancels operation and stops the alarm.
6		Cursor key	Moves the cursor.
7		Enter key	Sets the entries.
8		USER key	Changes the screen to the user registration screen.
9		MODE key	Change the user mode.

• **Reading the Display**

Numeric display screen



Graphic screen
Graph screen

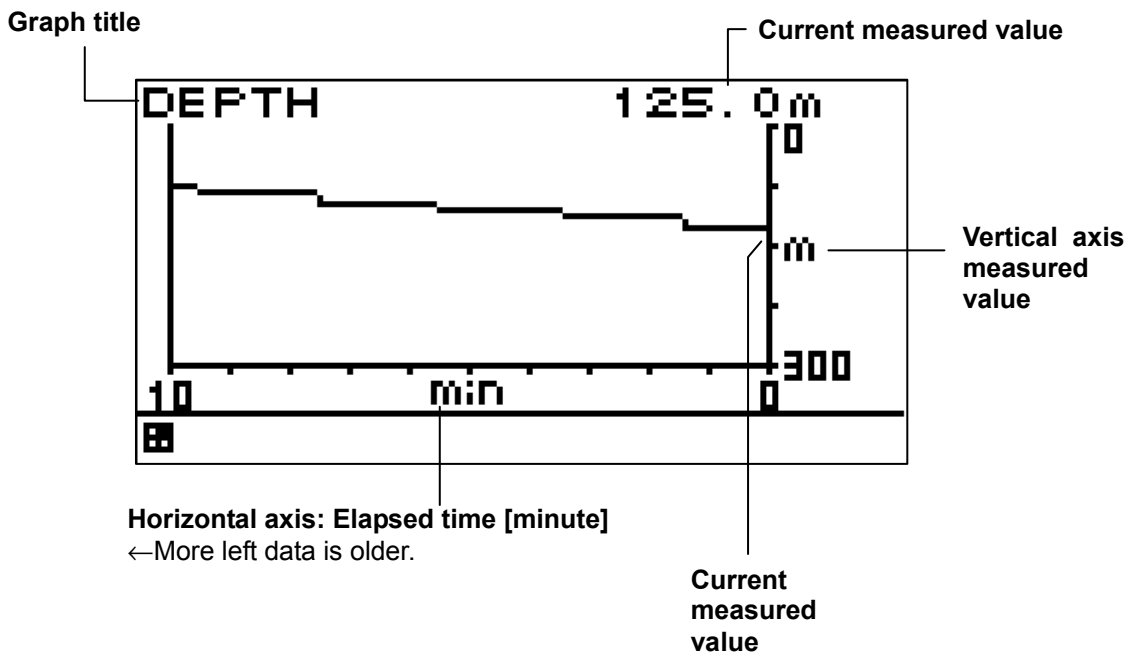

Wind direction/wind velocity screen

The left and right keys can be used to switch between true and relative.

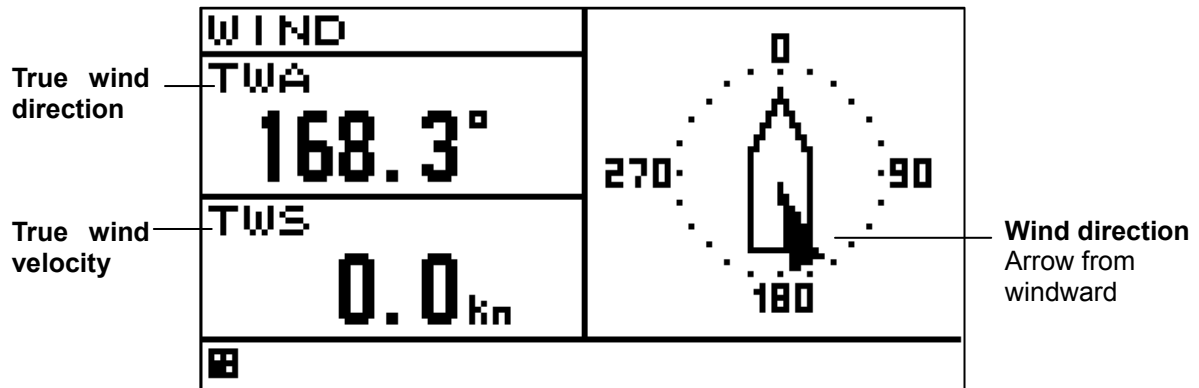

Special screen for JFE-380/680

1) Single Transducer

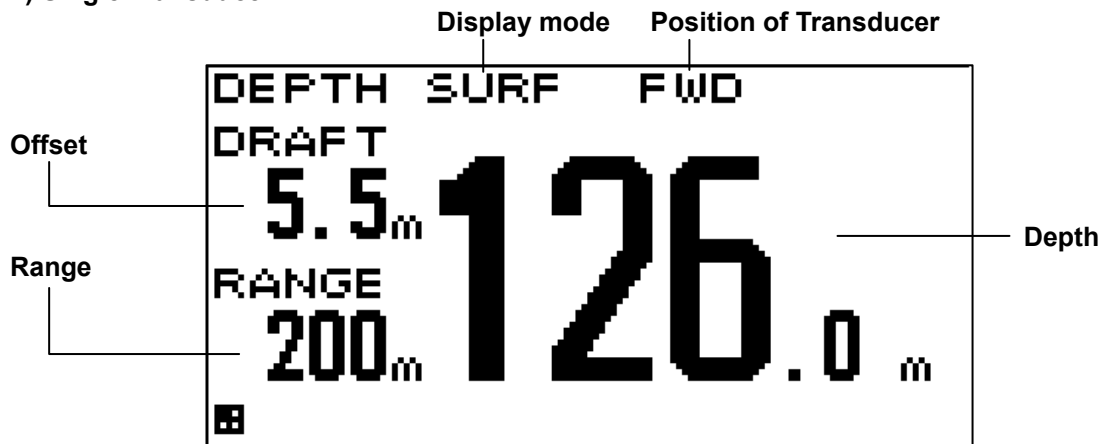

2) Dual Transducer

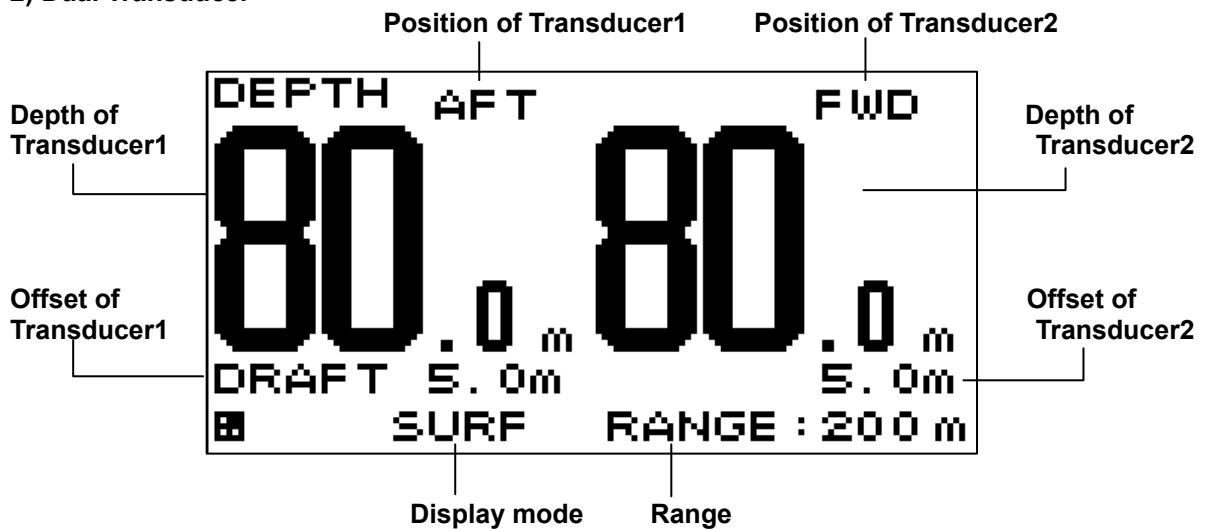

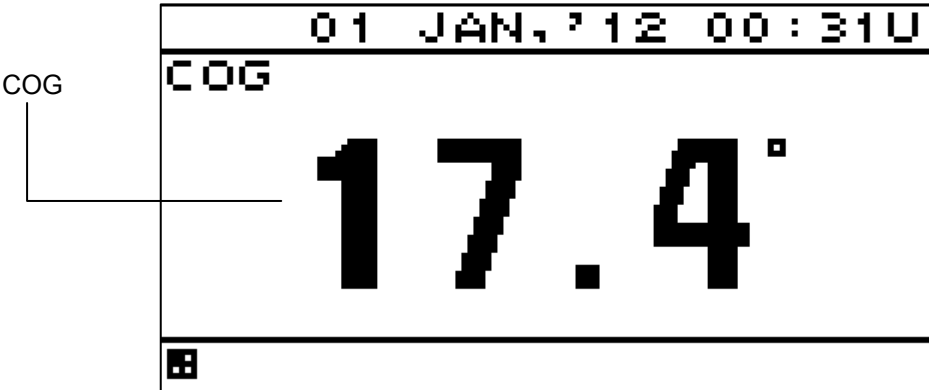

COG screen

When the COG is invalid, "---." is displayed.



Chapter 3 Display Screen

3.1. Display Screen

The screen is switched each time the  key is pressed. Up to six screens can be displayed. The screen after the power is turned on becomes the screen when it is turned off. When the  key is pressed, the mode is switched. The following screens are factory-set.

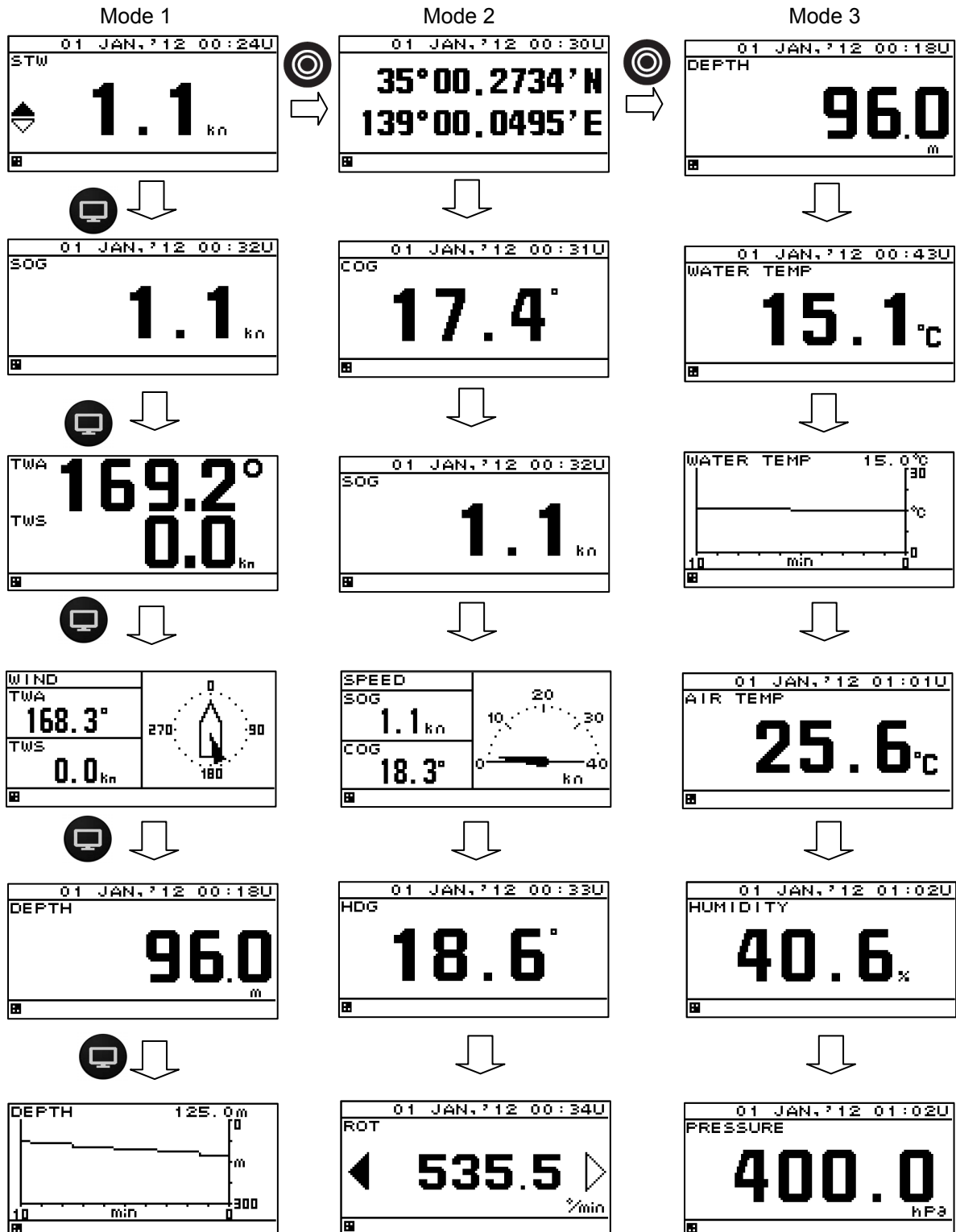

Split screen display

The screen can be split into 1 to 4 areas to display multiple information items.

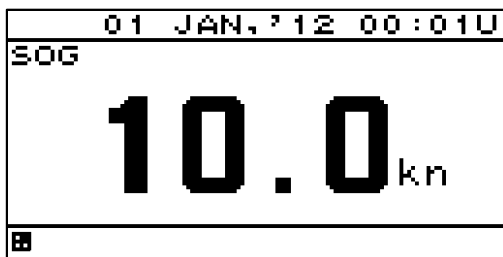

1-split screen

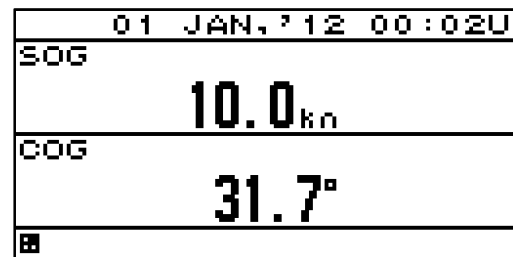

2-split screen

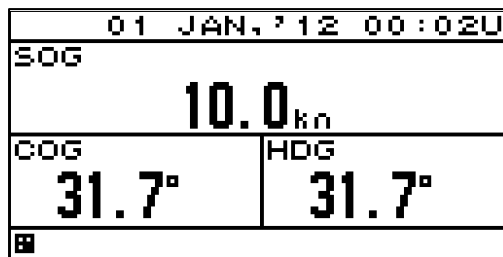

3-split screen

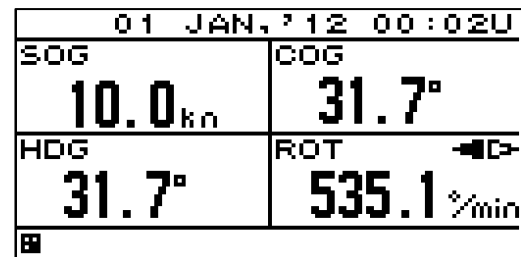

4-split screen

Enlarged part display

Integer part or decimal can be highlighted.

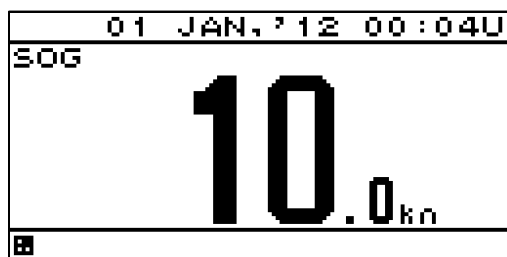

Enlarged integer part screen

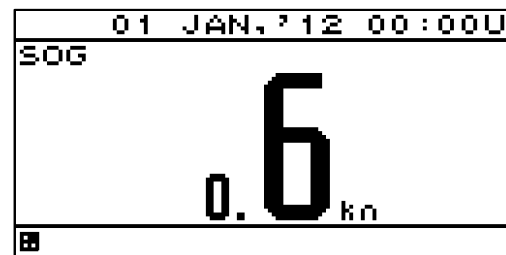

Enlarged decimal part screen

Chapter 4 Operation

WARNING



Do not place a vessel containing water, etc. or a metallic object on this unit. When water spills or when water or the object enters the unit, a fire, an electric shock, or a failure may occur.



Do not use this unit at a voltage other than the supply voltage stated on the unit. Otherwise, a fire, an electric shock, or a failure may occur.



Do not insert or remove the power cord or operate switches with a wet hand. Otherwise, you may suffer from an electric shock.



Do not damage or modify the power cord. Placing a heavy object onto, heating, stretching or bending the cord may cause a fire or an electric shock.

CAUTION



When this unit is suddenly moved from a cool place to a warm place, dew condensation water may form on the inside windows, and the liquid crystal part can become visually difficult. In this case, leave the unit for a while until becoming dry condition. Then operate the unit.

4.1. Menu

Normal menu

Main menu	Sub menu	Range	remarks
DISPLAY	LCD		4.5
	CONTRAST	1-13	4.5.1
	DIMMER MAXIMUM	4-13	4.5.2
	DIMMER TYPICAL	3-12	4.5.2
	DIMMER MINMUM	2-11	4.5.2
	CLICK SOUND	ON/OFF	4.5.3
	MODE1		4.5.4.1
	DISPLAY1		4.5.4.2
	SEGMENTATION1		4.5.4.3
	DISPLAY		4.5.4.4
	OWN SHIP	LAT/LON ^{※1} /HDG/ROT/COG/ SOG/PITCH/ROLL/HEAVING/	4.5.4.4
	NAVIGATION INFO	XTD/BRG/TTG/DTG/ETA	4.5.4.4
	WEATHER	WATER TEMP/TWA/TWS/AWA/AWS/ AIRTEMP/PRESSURE/HUMIDITY	4.5.4.4
	DOPPLER	TRIP/ODO/DEPTH/STW/ BOW STW/STERN STW/SOG(LOG)/ BOW SOG(LOG)/STERN SOG(LOG)/ CORRENT L1 SPD/CORRENT L1 DIR/ CORRENT L2 SPD/CORRENT L2 DIR/ CORRENT L3 SPD/CORRENT L3 DIR	4.5.4.4
	ENGINE	RUDDER/ENGINE/SHAFT	4.5.4.4
	OFF		4.5.4.4
	DISPLAY MODE	NORMAL/SPECIAL1/SPECIAL2/AUTO RANGE	4.5.4.4
	AUTO SCREEN	ON/OFF	4.5.4.4
	SOUND	SOUND1/SOUND2/OFF	4.5.4.4
	TIME	1-10sec	4.5.4.4
	SEGMENTATION2		4.5.4.3
	DISPLAY1/2	Same as DISPLAY1/1	4.5.4.4
	DISPLAY2/2	Same as DISPLAY1/1	4.5.4.4
	AUTO SCREEN	ON/OFF	4.5.4.4
	SOUND	SOUND1/SOUND2/OFF	4.5.4.4
	TIME	1-10sec	4.5.4.4
	SEGMENTATION3		4.5.4.3
	DISPLAY1/3	Same as DISPLAY1/1	4.5.4.4
	DISPLAY2/3	Same as DISPLAY1/1	4.5.4.4
	DISPLAY3/3	Same as DISPLAY1/1	4.5.4.4
	AUTO SCREEN	ON/OFF	4.5.4.4
	SOUND	SOUND1/SOUND2/OFF	4.5.4.4
	TIME	1-10sec	4.5.4.4
	SEGMENTATION4		4.5.4.3
	DISPLAY1/4	Same as DISPLAY1/1	4.5.4.4
	DISPLAY2/4	Same as DISPLAY1/1	4.5.4.4
	DISPLAY3/4	Same as DISPLAY1/1	4.5.4.4
	DISPLAY4/4	Same as DISPLAY1/1	4.5.4.4
	AUTO SCREEN	ON/OFF	4.5.4.4
	SOUND	SOUND1/SOUND2/OFF	4.5.4.4
	TIME	1-10sec	4.5.4.4
	SPECIAL		4.5.4.3
	DISPLAY	SINGLE DEPTH/DUAL DEPTH/WIND/ BEACON INFO/WAYPOINT INFO/ NAVIGATION INFO	4.5.4.4

※1 LAT/LON: Only SEGMENTAION1

Main menu	Sub menu	Range	remarks
	AUTO SCREEN	ON/OFF	4.5.4.4
	SOUND	SOUND1/SOUND2/OFF	4.5.4.4
	TIME	1-10sec	4.5.4.4
	GRAPHIC		4.5.4.3
	DISPLAY	WIND/ DEPTH/WATER TEMP/ SPEED1/SPEED2/RUDDER	4.5.4.4
	AUTO SCREEN	ON/OFF	4.5.4.4
	SOUND	SOUND1/SOUND2/OFF	4.5.4.4
	TIME	1-10sec	4.5.4.4
	OFF		4.5.4.3
	DISPLAY2	Same as DISPLAY1	4.5.4.2
	DISPLAY3	Same as DISPLAY1	4.5.4.2
	DISPLAY4	Same as DISPLAY1	4.5.4.2
	DISPLAY5	Same as DISPLAY1	4.5.4.2
	DISPLAY6	Same as DISPLAY1	4.5.4.2
	MODE2	Same as MODE1	4.5.4.1
	MODE3	Same as MODE1	4.5.4.1
	BACK LIGHT	WHITE/ORANGE	4.5.5
	GRAPH SCALE		4.5.6
	DEPTH		4.5.6
	TIME	5min/10min/20min/30min	4.5.6
	MAX	1-3048m	4.5.6
	MIN	0-3047m	4.5.6
	WATER TEMP		4.5.6
	TIME	5min/10min/20min/30min	4.5.6
	MAX	-36-+37°C	4.5.6
	MIN	-37-+36°C	4.5.6
	USER DISPLAY	DISPLAY1/DISPLAY2/DISPLAY3/ DISPLAY4/DISPLAY5/DISPLAY6/OFF	4.5.7
	TRIP RESET		4.5.8
SYSTEM	UNIT		4.6.1
	DIST/SPD	NM, kn/km, km/h/mi, mi/h/m, m/s	4.6.1
	TEMP	°C/°F/	4.6.1
	DEPTH	m/ft/fm	4.6.1
	WIND	kn/km/h/mi/h/m/s	4.6.1
	TIME DIFF	-13:30 - +13:30	4.6.2
	DATE DISP		4.6.3
	TIME DISP	DD MMM, 'YY HH:MM / MMM DD, 'YY HH:MM / YY-MMM-DD HH:MM	4.6.3
	MAG CORR		4.6.4
	DISPLAY	OFF/AUTO/MANUAL	4.6.4
	OUTPUT	OFF/AUTO/MANUAL	4.6.4
	LORAN C		4.6.5
	LORAN C	ON/OFF	4.6.5
	GRI		4.6.5
	TD1	0-99	4.6.5
	TD2	0-99	4.6.5
	TD1 CORR	-9.9 - +9.9	4.6.5
	TD2 CORR	-9.9 - +9.9	4.6.5
	DEPTH		4.6.6/4.6.7
	TRANS	FWD/MID/AFT	4.6.6
	OFFSET	-99.9 - +99.9	4.6.7
LANG.	LANG.	English/Japan/France/Germany/Italy/ Norway/Spain/Vietnam/Indonesia	4.7

Main menu	Sub menu	Range	remarks
ALARM	SYSTEM	ON/OFF	4.8.2
	SOUND	ON/OFF	4.8.12
	LCD COLOR	ON/OFF	4.8.12
	SPEED	OVER/UNDER/IN RANG/OUT RANG/OFF	4.8.3
	OVER		4.8.3
	OVER	0-99.9kn	4.8.3
	SOUND	ON/OFF	4.8.12
	LCD COLOR	ON/OFF	4.8.12
	UNDER		4.8.3
	UNDER	0-99.9kn	4.8.3
	SOUND	ON/OFF	4.8.12
	LCD COLOR	ON/OFF	4.8.12
	IN RANGE		4.8.3
	MAXIMAUM	0-99.9kn	4.8.3
	MINIMUM	0-99.9kn	4.8.3
	SOUND	ON/OFF	4.8.12
	LCD COLOR	ON/OFF	4.8.12
	OUT RANGE		4.8.3
	MAXIMAUM	0-99.9kn	4.8.3
	MINIMUM	0-99.9kn	4.8.3
	SOUND	ON/OFF	4.8.12
	LCD COLOR	ON/OFF	4.8.12
	TRIP	OVER/OFF	4.8.4
	OVER		4.8.4
	OVER	0-99.9kn	4.8.4
	SOUND	ON/OFF	4.8.12
	LCD COLOR	ON/OFF	4.8.12
	ARRIVAL	ARRIVAL/OFF	4.8.5
	SOUND	ON/OFF	4.8.12
	LCD COLOR	ON/OFF	4.8.12
	WATER TEMP	OVER/UNDER/IN RANG/OUT RANG/OFF	4.8.6
	OVER		4.8.6
	OVER	-99.9 - +99.9°C	4.8.6
	SOUND	ON/OFF	4.8.12
	LCD COLOR	ON/OFF	4.8.12
	UNDER		4.8.6
	UNDER	-99.9 - +99.9°C	4.8.6
	SOUND	ON/OFF	4.8.12
	LCD COLOR	ON/OFF	4.8.12
	IN RANGE		4.8.6
	MAXIMAUM	-99.9 - +99.9°C	4.8.6
	MINIMUM	-99.9 - +99.9°C	4.8.6
	SOUND	ON/OFF	4.8.12
	LCD COLOR	ON/OFF	4.8.12
	OUT RANGE		4.8.6
	MAXIMAUM	-99.9 - +99.9°C	4.8.6
	MINIMUM	-99.9 - +99.9°C	4.8.6
	SOUND	ON/OFF	4.8.12
	LCD COLOR	ON/OFF	4.8.12

Main menu	Sub menu	Range	remarks
	DEPTH	OVER/UNDER/IN RANG/OUT RANG/OFF	4.8.7
	OVER		4.8.7
	OVER	0 – 999.9m	4.8.7
	SOUND	ON/OFF	4.8.12
	LCD COLOR	ON/OFF	4.8.12
	UNDER		4.8.7
	UNDER	0 – 999.9m	4.8.7
	SOUND	ON/OFF	4.8.12
	LCD COLOR	ON/OFF	4.8.12
	IN RANGE		4.8.7
	MAXIMAUM	0 – 999.9m	4.8.7
	MINIMUM	0 – 999.9m	4.8.7
	SOUND	ON/OFF	4.8.12
	LCD COLOR	ON/OFF	4.8.12
	OUT RANGE		4.8.7
	MAXIMAUM	0 – 999.9m	4.8.7
	MINIMUM	0 – 999.9m	4.8.7
	SOUND	ON/OFF	4.8.12
	LCD COLOR	ON/OFF	4.8.12
	WIND	OVER/OFF	4.8.8
	OVER		4.8.8
	OVER	99.9kn	4.8.8
	SOUND	ON/OFF	4.8.12
	LCD COLOR	ON/OFF	4.8.12
	AIR TEMP	OVER/UNDER/IN RANG/OUT RANG/OFF	4.8.9
	OVER		4.8.9
	OVER	-99.9 - +99.9°C	4.8.9
	SOUND	ON/OFF	4.8.12
	LCD COLOR	ON/OFF	4.8.12
	UNDER		4.8.9
	UNDER	-99.9 - +99.9°C	4.8.9
	SOUND	ON/OFF	4.8.12
	LCD COLOR	ON/OFF	4.8.12
	IN RANGE		4.8.9
	MAXIMAUM	-99.9 – +99.9°C	4.8.9
	MINIMUM	-99.9 – +99.9°C	4.8.9
	SOUND	ON/OFF	4.8.12
	LCD COLOR	ON/OFF	4.8.12
	OUT RANGE		4.8.9
	MAXIMAUM	-99.9 – +99.9°C	4.8.9
	MINIMUM	-99.9 – +99.9°C	4.8.9
	SOUND	ON/OFF	4.8.12
	LCD COLOR	ON/OFF	4.8.12

Main menu	Sub menu	Range	remarks
	PRESSURE	OVER/UNDER/IN RANG/OUT RANG/OFF	4.8.10
	OVER		4.8.10
	OVER	0 – 9999.9 hPa	4.8.10
	SOUND	ON/OFF	4.8.12
	LCD COLOR	ON/OFF	4.8.12
	UNDER		4.8.10
	UNDER	0 – 9999.9 hPa	4.8.10
	SOUND	ON/OFF	4.8.12
	LCD COLOR	ON/OFF	4.8.12
	IN RANGE		4.8.10
	MAXIMAUM	0 – 9999.9 hPa	4.8.10
	MINIMUM	0 – 9999.9 hPa	4.8.10
	SOUND	ON/OFF	4.8.12
	LCD COLOR	ON/OFF	4.8.12
	OUT RANGE		4.8.10
	MAXIMAUM	0 – 9999.9 hPa	4.8.10
	MINIMUM	0 – 9999.9 hPa	4.8.10
	SOUND	ON/OFF	4.8.12
	LCD COLOR	ON/OFF	4.8.12
	HUMIDITY	OVER/UNDER/IN RANG/OUT RANG/OFF	4.8.11
	OVER		4.8.11
	OVER	0 – 99.9 %	4.8.11
	SOUND	ON/OFF	4.8.12
	LCD COLOR	ON/OFF	4.8.12
	UNDER		4.8.11
	UNDER	0 – 99.9 %	4.8.11
	SOUND	ON/OFF	4.8.12
	LCD COLOR	ON/OFF	4.8.12
	IN RANGE		4.8.11
	MAXIMAUM	0 – 99.9 %	4.8.11
	MINIMUM	0 – 99.9 %	4.8.11
	SOUND	ON/OFF	4.8.12
	LCD COLOR	ON/OFF	4.8.12
	OUT RANGE		4.8.11
	MAXIMAUM	0 – 99.9 %	4.8.11
	MINIMUM	0 – 99.9 %	4.8.11
	SOUND	ON/OFF	4.8.12
	LCD COLOR	ON/OFF	4.8.12
	BEACON	ON/OFF	4.9

Maintenance menu

Main menu	Sub menu	Range	Reference/remarks
DAISY CHAIN		ON/OFF	4.11
INTERFACE	DATA I/O		4.10.5
	DATA IN/OUT1		4.10.5
	NMEA		4.10.5
	DATA IN/OUT	SEND/RECEIVE	4.10.5
	VERSION	1.5/2.1/2.3/4.0	4.10.5 SEND only
	SENTENCE	Sentence list	4.10.5 SEND only
	BIT RATE	4800/9600/19200/38400	4.10.5
	IEC		4.10.5
	DATA IN/OUT	SEND/RECEIVE	4.10.5
	SENTENCE	Sentence list	4.10.5 SEND only
	BIT RATE	4800/9600/19200/38400	4.10.5
	JRC		4.10.5
	INTERVAL	OFF/4s	4.10.5
	DATA IN/OUT2		4.10.5
	NMEA		4.10.5
	DATA IN/OUT	SEND/RECEIVE	4.10.5
	VERSION	1.5/2.1/2.3/4.0	4.10.5 SEND only
	SENTENCE	Sentence list	4.10.5 SEND only
	BIT RATE	4800/9600/19200/38400	4.10.5
	IEC		4.10.5
	DATA IN/OUT	SEND/RECEIVE	4.10.5
	SENTENCE	Sentence list	4.10.5 SEND only
	BIT RATE	4800/9600/19200/38400	4.19.5
	JRC		4.10.5
	INTERVAL	OFF/4s	4.10.5
	DATA IN/OUT3		4.10.5
	NMEA		4.10.5
	DATA IN/OUT	SEND/RECEIVE	4.10.5
	VERSION	1.5/2.1/2.3/4.0	4.10.5 SEND only
	SENTENCE	Sentence list	4.10.5 SEND only
	BIT RATE	4800/9600/19200/38400	4.10.5
	IEC		4.10.5
	DATA IN/OUT	SEND/RECEIVE	4.10.5
	SENTENCE	Sentence list	4.10.5 SEND only
	BIT RATE	4800/9600/19200/38400	4.10.5
	JRC		4.10.5
	INTERVAL	OFF/4s	4.10.5
	DATA IN/OUT4		4.10.5
	NMEA		4.10.5
	VERSION	1.5/2.1/2.3/4.0	4.10.5 SEND only
	SENTENCE	Sentence list	4.10.5 SEND only
	BIT RATE	4800/9600/19200/38400	4.10.5
	IEC		4.10.5
	SENTENCE	Sentence list	4.10.5 SEND only
	BIT RATE	4800/9600/19200/38400	4.10.5
	JRC		4.10.5
	INTERVAL	OFF/4s	4.10.5
	RS-485		4.10.4.4
	NMEA		4.10.4.4
	VERSION	1.5/2.1/2.3/4.0	4.10.4.4 SEND only
	SENTENCE	Sentence list	4.10.4.4 SEND only
	BIT RATE	38400/57600/76800/115200	4.10.4.4

Main menu	Sub menu	Range	Reference/remarks
	IEC		4.10.4.4
	SENTENCE	Sentence list	4.10.4.4 SEND only
	BIT RATE	38400/57600/76800/115200	4.10.4.4
	CONTACT INPUT	DIMMER/ACK	4.10.6.1
	CONTACT OUTPUT	200PULSE/NM/ 400PULSE/NM/ OFF	4.10.6.2
	DIAGNOSIS	CONFIG OUT/ERROR LOG OUT	4.10.7/4.10.15
MAINTENANCE	INPUT DATA		4.10.9
	DIAGNOSIS		4.10.10
	DISPLAY DIAG		4.10.10
	MONITOR TEST		4.10.10
	BUZZER TEST		4.10.10
	ERROR LOG		4.10.11
	ALARM		4.10.11
	ERROR LOG		4.10.11
	SOFT VERSION		4.10.12
	DISPLAY VER		4.10.12
	APP VER		4.10.12
	SERIAL NUMBER		4.10.12
	BARCODE		4.10.12
MASTER RESET	GRAPH RESET		4.10.13
	DISPLAY RESET		4.10.13
DEMO MODE	DEMO TYPE		4.10.14
	STATIC		4.10.14
	COURSE	0-359.9°	4.10.14
	STRAIGHT		4.10.14
	SPEED	0-99.9kn	4.10.14
	COURSE	0-359.9°	4.10.14
	RIGHT		4.10.14
	SPEED	0-99.9kn	4.10.14
	COURSE	0-359.9°	4.10.14
	LEFT		4.10.14
	SPEED	0-99.9kn	4.10.14
	COURSE	0-359.9°	4.10.14
	DATE		4.10.14
	TIME		4.10.14
	LATITUDE		4.10.14
	LONGITUDE		4.10.14
	DEMO MODE	START/END	4.10.14
SOFT UPDATE	DISPLAY		—
DESPRAY TYPE		MID/LOG/GPS/OFF	4.10.2 Factory setting: OFF
RS-485ID		1-10	4.10.4
DIMMER GROUP		1-10	4.10.4.3
DIMMER		KEY/EXT DIMMER	4.10.3
CURRENT		LAYER/DATA No	4.10.16

4.2. Basic Operation

4.2.1. Turning on the power

When the main power is turned on, the power to the display unit is automatically turned on.

In the state in which the power is turned off by the display unit key operation, pressing the  key turns on the power.

When the main power is OFF



Turning on the main power

When the main power is ON



Pressing the power key

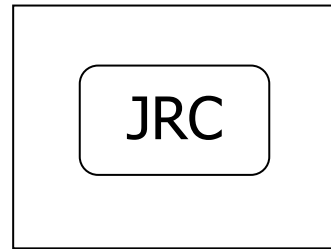

Turning on the power

When the power is ON for first time.

The following screen is displayed. Select a Model with  and press .

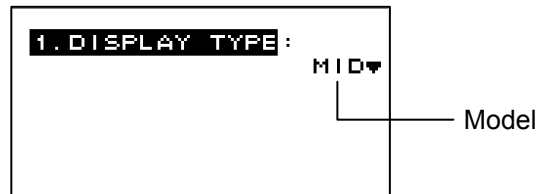

When "LOG" is selected by mistake

Refer to "Caution" in "4.10.2 setting a model".

Caution

If the power cannot be turned on, check the main power of the power distribution board and the cable connection to the display unit.

4.2.2. Starting (Normal)

If all the self-check results are 'OK', the screen is automatically changed to the normal screen.

```
SELF DIAGNOSING...
ROM CHECK:OK
RAM CHECK:OK
SC10 CHECK:OK
SC11 CHECK:OK
SC12 CHECK:OK
SC13 CHECK:OK
SC16 CHECK:OK
```

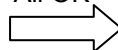
All OK 

```
01 JAN.'12 00:24U
STW
1.1 kn
```

4.2.3. Starting (Abnormal)

If the self-diagnosis results are errors “NG,” the results are displayed as follows.



Caution



When any abnormality (NG) is found, contact JRC or one of our agents.

4.2.4. Starting (Abnormal)

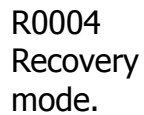
When the program is corrupted, the following screen is displayed. Turn off the power and contact JRC or one of our agents.

A rectangular box representing a screen display. The text inside is centered and reads "R0004" on the first line, "Recovery" on the second line, and "mode." on the third line.

4.2.5. Turning off the power

If the  key and the  key are pressed and held down simultaneously, the power will be turned off and the screen display will turn off.

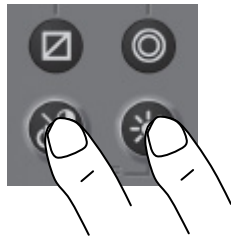

Supplement

The power may be turned on due to the release timing of your finger.

In this case, first release the  and then release the .

4.2.6. Adjusting the back light (lighting) by using the key

The brightness of display and operation panel backlight can be set to one of four levels (bright, medium, dark, off).

Whenever  is pressed, the level changes in the order of bright – medium – dark – off –dark – medium – bright.



Supplement

- The brightness levels other than “off” can be set. See “4.5.2 Adjusting back light”.
- An external dimmer unit can also be used for adjusting brightness. See “4.10.3 Selecting a dimmer unit”.

4.2.7. Adjusting contrast

Contrast can be adjusted over 13 levels.

Whenever  is pressed, the contrast is reduced (or increased) from the current setting and after the contrast reaches the lowest (or highest) level, the contrast increases (reduces) gradually.



4.2.8. Turning off the alarm buzzer

Buzzer sound can be turned off by pressing . The buzzer sounds if an alarm occurs.

4.2.9. Switching display

The display screen is switched whenever  is pressed.

4.2.10. Alarm display

When an alarm occurs, the event is notified with a popup menu and alarm sound.

When  is pressed, the popup menu is cleared and the buzzer sound stops. However, display of **AL** remains on the status bar unless the alarm is cancelled.



Even after the popup menu is cleared and the buzzer sound is stopped, the invalid numerical number keeps blinking until the alarm is cancelled.

To check the alarm again after clearing the popup menu, display the alarm history by referencing “4.10.11 Displaying an alarm”

4.2.11. Selecting items from the menus





This section shows the procedure for selecting items from the menus and determining the selection.

Procedure

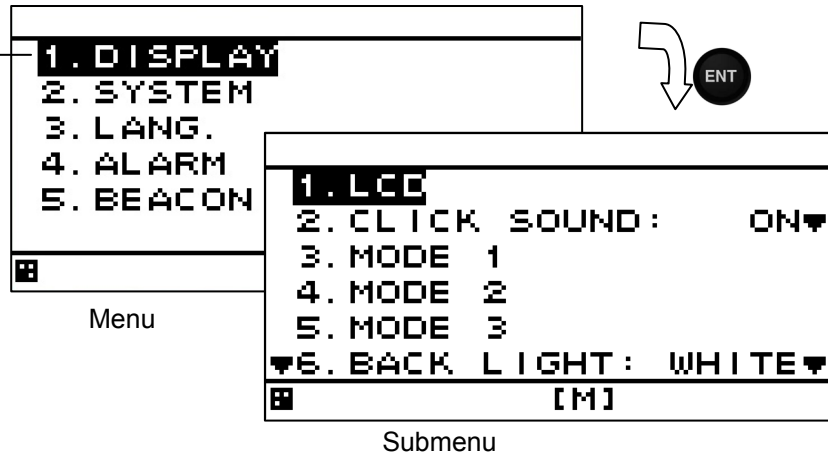

1. Move the cursor to a required item by using  and press . The item is selected and a submenu is opened to enable selection of details.

The selected item is displayed in reverse video.

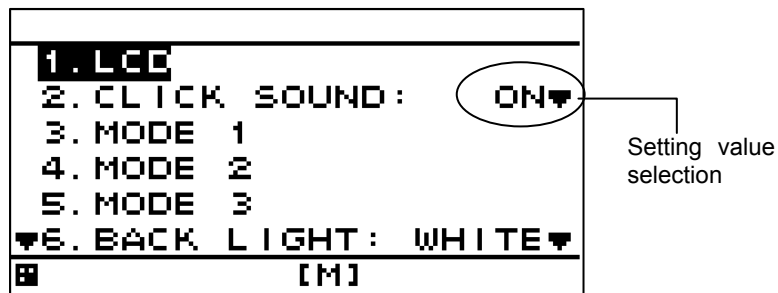

2. Move the cursor to a required item by using  and press . The cursor moves to the setting value selection.
3. Select a setting value with  and press  or . The setting value is confirmed.



4. To return to the previous item, press  or .







Supplement

Power must not be off for 10 seconds after setting. When not doing so, the setting value may not be saved.



4.2.12. Entering a numeric value

This section describes the procedure for entering a numeric value.

Procedure

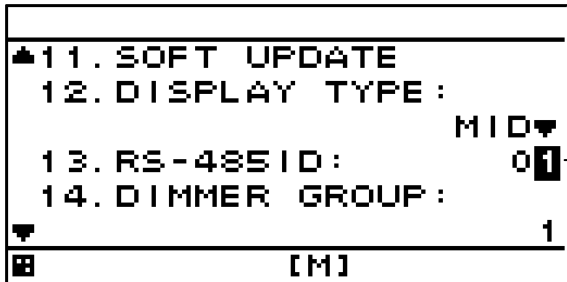
1. Move the cursor to the field in which a value is to be entered by using .
2. Set a numeric value to be entered by using  and press  or .
3. Move the cursor to the right most field and press  or . The setting value is confirmed.



Select a field by using 
Select a numeric value by using 

Supplement

If the numeric value that can be entered is restricted by an input range, enter the digits from the highest order.

To prevent the value from exceeding the input range, the input of the low-order digits is restricted by the value of the high-order digit.

Example) The input range is from 1 to 10:

If 1 is input in the high-order digit, only 0 can be set as the low order digit.

Power must not be off for 10 seconds after setting. When not doing so, the setting value may not be saved.

4.3. User Mode Change

The user mode can be changed.

Up to three user modes are available, and six screens can be registered in one mode.

For details about how to register the screens in each mode, refer to “4.5.4 Setting a display screen”.

Procedure

1. Press the  key.

Each time the key is pressed, mode 1 changes to mode 2 and to mode 3.

4.4. User Setting Screen Display

From among the screens registered in the display screen, the user-set screen can be displayed.

The user-set screen can also be displayed quickly from other screen by registering the most often-used screen.

The user-set screen cannot be registered in each use mode.

For details about how to set user screen, refer to “4.5.7 Registering user display”.

Procedure

1. Press the  key.

To return to the original screen, press the  key.

4.5. Setting Display

When "Display" is selected on the main menu, a display menu is displayed.

On the display menu, LCD (contrast and back light), click sound, screen selection, and back light color can be set.

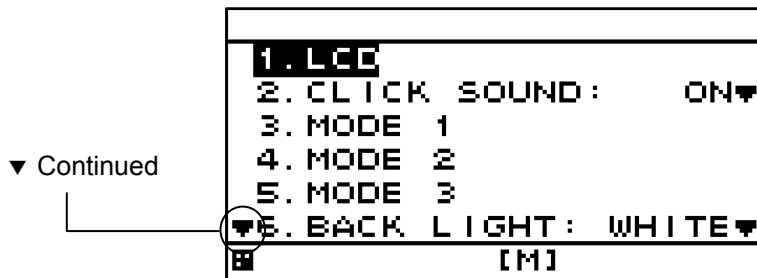





Each submenu is outlined below.

- | | |
|------------------|-----------------------------------------------------|
| 1) LCD: | Adjusts the contrast and sets the back light level. |
| 2) CLICK SOUND: | Turns on/off the click sound. |
| 3) MODE 1: | You can select MODE 1 screen. |
| 4) MODE 2: | You can select MODE 2 screen. |
| 5) MODE 3: | You can select MODE 3 screen. |
| 6) BACK LIGHT: | You can select the brightness color (white/orange). |
| 7) GRAPH SCALE: | You can set the depth and temperature graph scale. |
| 8) USER DISPLAY: | You can select the user-set screen. |
| 9) TRIP RESET: | You can reset the trip distance. |

4.5.1. Adjusting contrast

- Adjust the LCD contrast.
- The darkest contrast is 1 and the lightest contrast is 13.
- The default setting is 7.

Procedure



1. Display a main menu by pressing .
2. Select "DISPLAY", "LCD", and "CONTRAST" in this order by using .
3. Enter a contrast value by using  and press .

4.5.2. Adjusting back light

- Brightness can be changed by using . Four levels of brightness are available, bright, medium, dark, and off.

This section shows how to set a level value of each brightness.

Procedure

- Display a main menu by pressing .
- Select "DISPLAY", "LCD", and "DIMMER MAXIMUM/TYPICAL/MINIMUM" in this order by using .
- Select a brightness value by using  and press .





Supplement

Enter the highest value in "MAXIMUM" and the lowest value in "MINIMUM".

4.5.3. Setting a click sound

- Turn on/off a key-operation click sound.
ON: Enables a click sound. When the key is pressed, a click sound is emitted.
OFF: Disables a click sound.

Procedure

- Display a main menu by pressing .
- Select "DISPLAY" and "CLICK SOUND" in that order by using .
- Select "ON" or "OFF" by using  and press .

4.5.4. Setting a display screen

Up to six display screens can be registered in this display unit.

The display screen can be switched either manually by using  or automatically (auto screen function).

The auto screen function enables the setting of a switching interval. Switching can also be notified by emitting a buzzer sound.

Only the integer section or the decimal section of a indication character can be expanded and displayed. (Display mode)

The setting of the auto screen function and the display mode are performed by "STEP3."

The screen structures of each display screen include customized screens that can be set freely, special screens that do not allow any setting, and graphic screens. The contents to be displayed on the display screen can be selected.

The screen selection procedure is as follows.

- STEP1 Select the display screen from user mode.
- STEP2 Select a screen structure.
- STEP3 Select the display contents.

4.5.4.1. Selecting User Mode

MID can set up to three user modes.



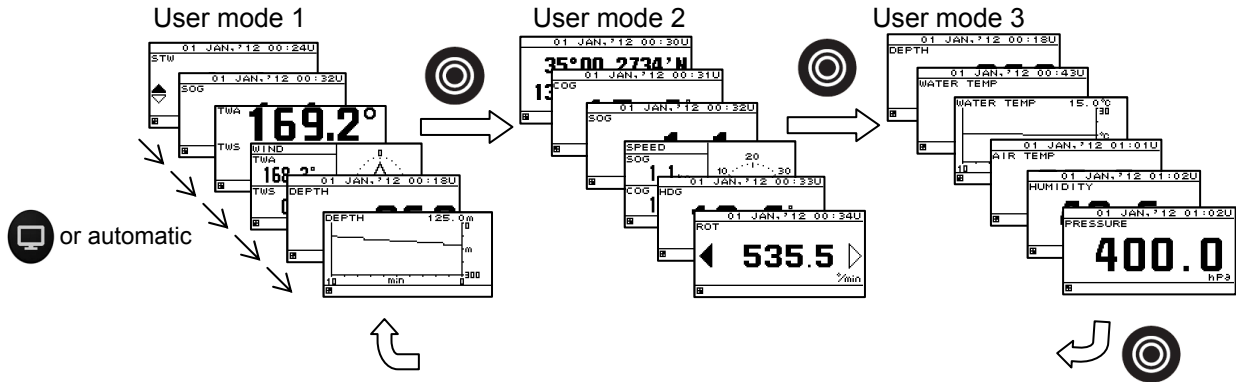

Up to six screens can be registered in each mode, and up to 18 screens can be registered.

Press the  key to change the set user mode.



Select the user mode before selecting the display screen.

Procedure

1. Display a main menu by pressing  (normal mode).
2. Press the  key to select "DISPLAY," and press the  key.
3. Press the  key to select "MODE1," "MODE2," or "MODE3," and press the  key.

Supplement

• User mode

The user mode refers to scenes such as going to a waypoint, arriving at a waypoint, calling at a port,

The user can select more convenient screens by registering six screens that suit each scene (user mode).

4.5.4.2. STEP1 Selecting a display screen

Up to six display screens can be registered in this display unit.

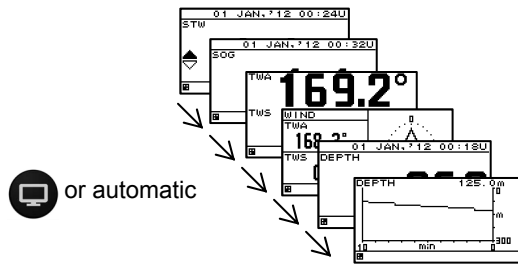

Procedure

1. Display a main menu by pressing (normal mode).
2. Press the key to select “DISPLAY,” “MODE1,” “MODE2,” or “MODE3” in order, and press the key to select the user mode.
3. Press the key to select display screen from “DISPLAY1” to “6.DISPLAY6,” and press the key.

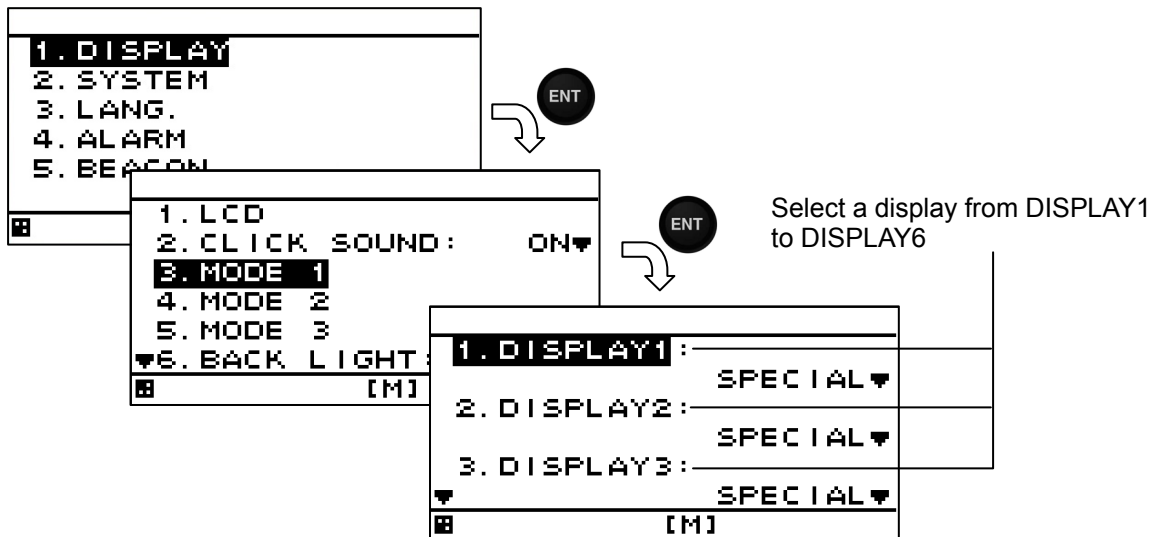

4.5.4.3. STEP2 Selecting a screen structure

The screen structures of each display screen include customized screens that can be set freely, special screens that do not allow any setting, and graphic screens.

Select a screen structure.

When display structure selection is set to "OFF", the display screen cannot be registered.

Customized screen

One screen can be segmented into screens 1 to 4. Up to four contents can be displayed concurrently.

Special screen and graphic screen

Users cannot change the screen structure. Special contents for the model are displayed on the screen.

The following screen structures can be selected.

- 1) SEGMENTATION1: Full screen
- 2) SEGMENTATION2: The screen is segmented into two sections.
- 3) SEGMENTATION3: The screen is segmented into three sections.
- 4) SEGMENTATION4: The screen is segmented into four sections.
- 5) SPECIAL: Special screen for MID.
- 6) GRAPICH: Graphic screen
- 7) OFF: The screen can not be registered.

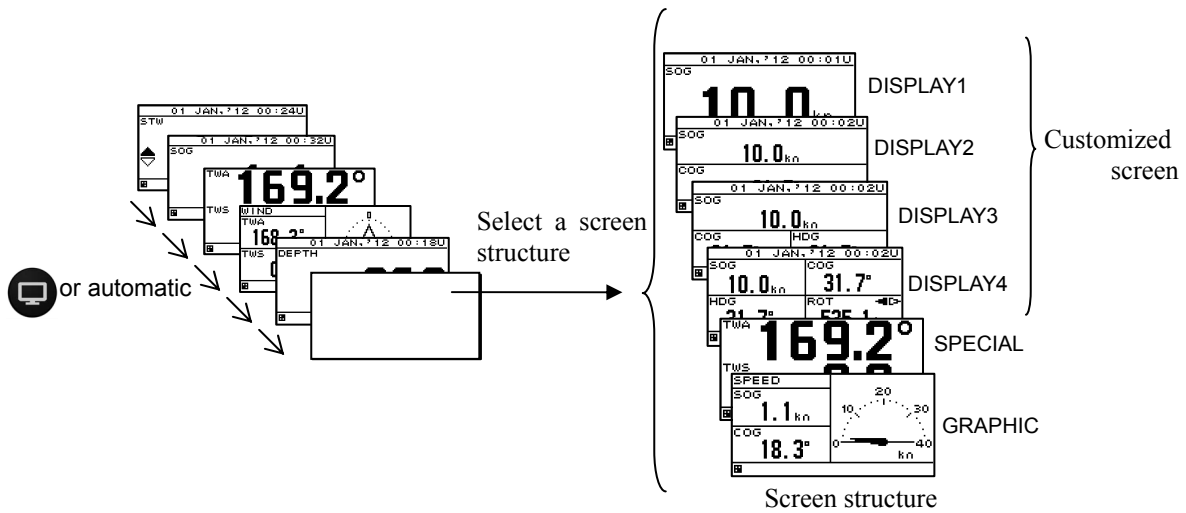

Procedure

1. Select a display screen by referencing "STEP1".
2. Select a screen structure from "SEGMENTATION1", "SEGMENTATION2", "SEGMENTATION3", "SEGMENTATION4", "SPECIAL", "GRAPHIC" and "OFF" by using and press .

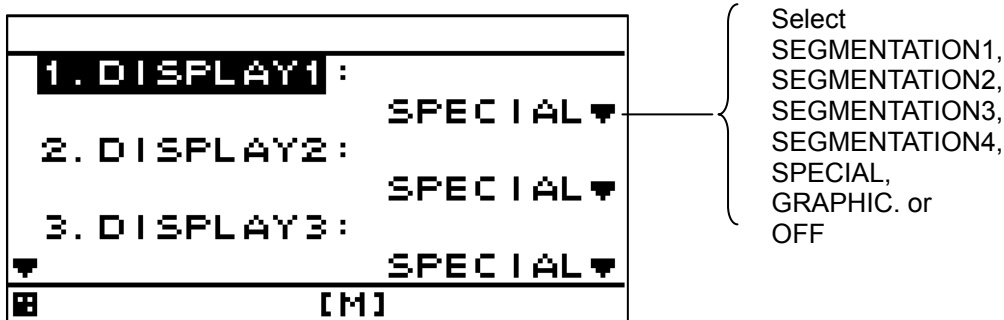

4.5.4.4. SETP3 Selecting display contents

Select as many display contents as the number of screens that are created by segmentation. For instance, for a 2-segmentation screen, select the display content for one half of the screen and then select the display content for the other half of the screen (see the diagram below).

The display content of a customized screen is divided according to the category. Initially, select a category and a display item. "Table4-1 shows the categories and display contents".

A special screen and a graphic screen are not classified according to the category.

Only the integer part or a decimal part of some item that is selected on a 1-segmentation customized screen can be expanded (Display mode).

If display content selection is set to "OFF", no information is displayed in the area.

Set the auto screen function and display mode (only segmentation 1 screen) in STEP3. The following functions can be set.

- 1-1) AUTO SCREEN: ON – Enables the auto screen function.
 OFF – Disables the auto screen function.
- 1-2) SOUND : SOUND1 – The buzzer of "Pippi" sound is sounded at the time of a screen change.
 SOUND2 – The buzzer of "Pip" sound is sounded at the time of a screen change.
 OFF – Does not emit a buzzer sound even if the screen is switched.
- 1-3) TIME: Sets a screen switching time. A time of up to 10 seconds can be set.
- 2-1) DISPLAY MODE : normal It displays in the character of the same size.
 special 1 Only integer part is expanded and displayed.
 special 2 Only a decimal part is expanded and displayed.
 auto range Integer part or a decimal part is expanded and it displays the optimal.

Example) Procedure for selecting display contents for a 2-segmentation screen

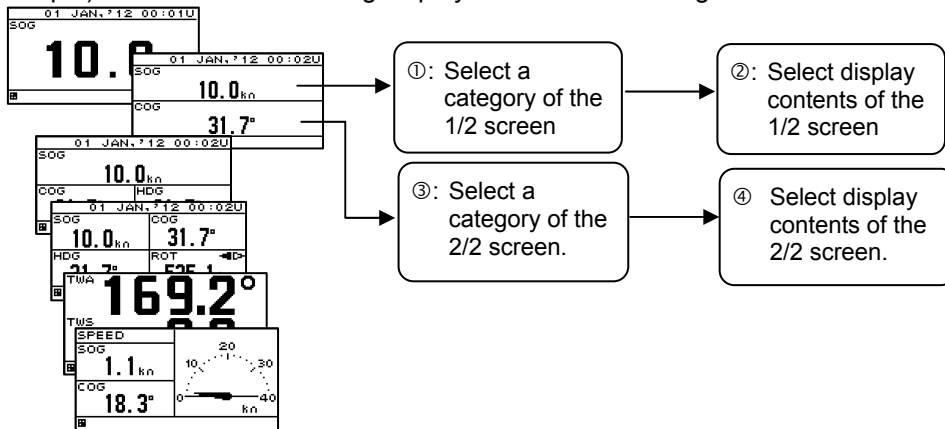

Screen structure

Selecting display contents for 2-segmentation screen

Procedure

1. Select a screen structure by referencing "STEP1" and "STEP2".

Customized screen

2. Select a screen section to be displayed by using  and press .

Select the screen section from the following:

segmentation1 screen: "DISPLAY"

segmentation2 screen: "DISPLAY 1/2" "DISPLAY 2/2"

segmentation3 screen: "DISPLAY 1/3" "DISPLAY 2/3" "DISPLAY 3/3"

segmentation4 screen: "DISPLAY 1/4" "DISPLAY 2/4" "DISPLAY 3/4" "DISPLAY 4/4"

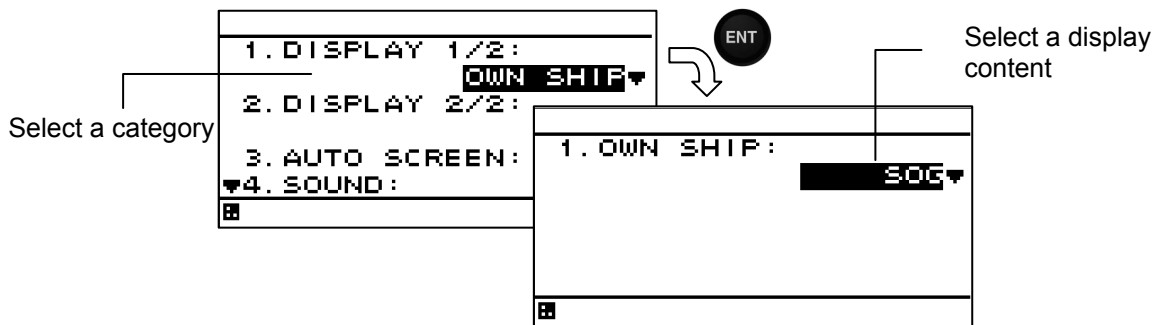

3. Select a category by using and press .
4. Select display contents by using and press .
5. Go to procedure 6 when setting an auto screen.

Fixed screen and graphic screen

2. Select "DISPLAY" by using and press .
3. Select display contents by using and press .
4. Go to procedure 6 when setting an auto screen.

Table4-1 Display category and display contents

Category	Display contents
OWN SHIP	LAT/LON※ ¹ , SOG, COG, HDG(Heading), ROT, PITCH, ROLL, HEAVING
NAVIGATION INFO	XTD,BRG,TTG,DTG,ETA
WEATHER	Temperature, true wind direction, true wind velocity, relative wind direction, relative wind velocity, air temperature, atmosphere, humidity
DOPPLER	Forward/backward speed through water, bow speed through water, stem speed through water, forward/backward speed over ground, bow speed over ground, stem speed over ground, layer L1 current direction, layer L1 current speed, layer L2 current direction, layer L2 current speed, layer L3 current direction, layer L3 current speed, TRIP, ODO (Odometer), water depth
ENGINE	Rudder angle, engine speed, shaft speed
Special screen	Single mode water depth, dual mode water depth, wind direction/wind velocity, Navigation info, Beacon info, Waypoint info
Graphic screen	Speed1, Speed2, rudder angle, wind direction, water depth graph, water temperature graph





※1) LAT/LON Only SEGMENTATION1

Setting an auto screen

On an auto screen, set a screen switching time and whether a buzzer sound is emitted at screen switching.





6. Select "ON" or "OFF" under "AUTO SCREEN" by using and press .

- Select "SOUND1", "SOUND2" or "OFF" under "SOUND" by using  and press .
- Select "TIME" by using .
- Enter a switching time by using  and press .

Starting an auto screen

- Switching the USER MODE to use an auto screen function
- Press and hold  for 1 second or more.

Stopping an auto screen

- Press any keys except  and .

Setting a display mode

The display mode can be set only with segmentaion1 screen.





The contents of a display with an effective auto range are SOG, STW, ROT, depth, current, trip, and total distance (ODO).

Even if it sets up an auto range by the other contents of a display, it becomes the normal display.

An auto range changes a display in the following range.

Auto range

The contents of a display	Integer part expanded display	Usual display	Decimal part expanded display
SOG/STW	10kn or more	1.0 - 9.9kn	0.9kn or less
ROT	More than 600° / min	1.0-599.9° / min	0.9° / min or less
Depth	10 m or more	9.9m or less	-
Total distance/ Trip	10NM or more	1.00 - 9.99NM	0.99NM or less
Current	10kn or more	1.0 - 9.9kn	0.9kn or less
TTG	2 hours or more	60min-1hr59min	59min or less

- The contents of a display are set up with the above-mentioned operating procedure.
- Select the "DISPLAY MODE" by using  and press .
- Select the "NORMAL", "SPECIAL1", "SPECIAL2" or "AUTO RANGE" by using  and press .

Example) SOG display

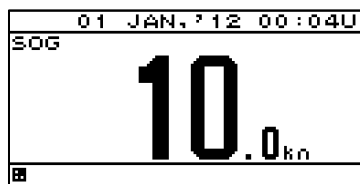

Integer part expanded display

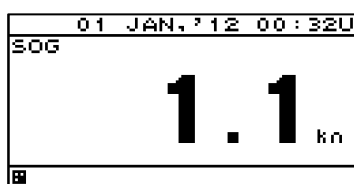

Normal display

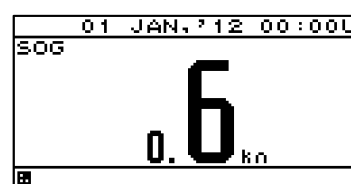





Decimal part expanded display

4.5.5. Selecting a back light color

Select white or orange as the back light color of the screen that is normally used.

Procedure

- Display a main menu by pressing .
- Select "1. DISPLAY" and "BACK LIGHT" in this order by using .
- Select "WHITE" or "ORANGE" by using  and press .

4.5.6. Setting graph scale

The vertical axis and horizontal axis scale of the water temperature and water depth graphs can be set. For detail screen, refer to page 2-2.

Horizontal axis setting

TIME: The maximum display time of the horizontal axis is set.
The time that can be set is 5 minutes, 10 minutes, 20 minutes, and 30 minutes.

Vertical axis setting



MAX: The maximum value of the display value is set.

MIN: The minimum value of the display value is set.



Procedure

1. Press the  key to display the main menu.

Water depth

2. Press the  key to select "DISPLAY," "GRAPH SCALE," and "DEPTH" in order.
3. Press the  key to enter "TIME," "MAX," or "MIN," and press the  key.





Water temperature

2. Press the  key to select "DISPLAY," "GRAPH SCALE," and "WATER TEMP" in order.
3. Press the  key to enter "TIME," "MAX," or "MIN," and press the  key.

4.5.7. Registering user display

From among the screens registered in the display screen, the user display assigned to the  key can be registered.



Procedure

1. Press the  key to display the main menu.
2. Press the  key to select "DISPLAY" and "USER DISPLAY" in order.
3. Press the  key to select the screens to be registered from "DISPLAY1" to "DISPLAY6," and press the  key.

4.5.8. Resetting a TRIP

A trip distance can be reset.

Procedure

1. Press the  key to display the main menu.
2. Press the  key to select "DISPLAY" and "TRIP RESET" in order.
3. Select "YES" and press the  key.

4.6. System Settings

Select "SYSTEM" on the main menu to display the system settings screen. To change the system settings, place the unit in maintenance mode.

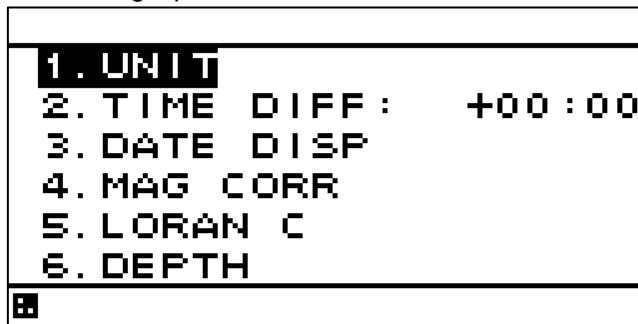

An overview of each submenu is as follows.

- 1) UNIT: Set the units of distance/ship speed, temperature, water depth, and wind velocity.
- 2) TIME DIFF: Set the time difference between UTC and local time.
- 3) DATA DISP: Select the date format.
- 4) MAG CORR: Automatic or manual magnetic correction or turn magnetic correction off can be selected
- 5) LORAN C: Convert latitude and longitude to LORAN C time difference.
- 6) DEPTH: Set the position and offset of the transducer that displays the water depth.

4.6.1. Selecting units

You can set the units of distance/ship speed to NM, kn, km, km/h, mi, mi/h or m, m/s.

You can set the unit of temperature to °C or °F.

You can set the unit of water depth to m, ft or fm.

You can set the unit of wind velocity to kn, km/h, mi/h or m/s.

Procedure

1. Refer to "4.10.1 Changing to a maintenance mode" to display the maintenance menu.
2. Press the key to select "SYSTEM" and "UNIT" in order.
3. Press the key to select "DIST/SPD," "TEMP," "DEPTH" or "WIND."
4. Press the key to select the unit, and press the key.

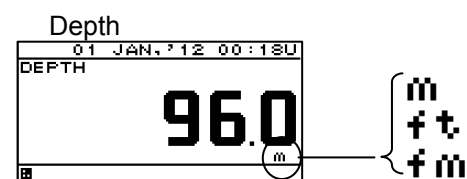
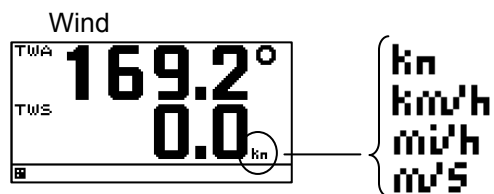
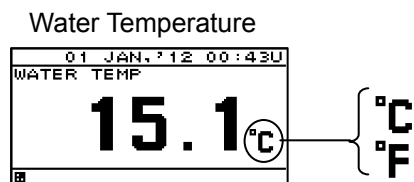
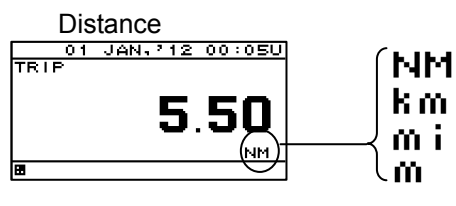
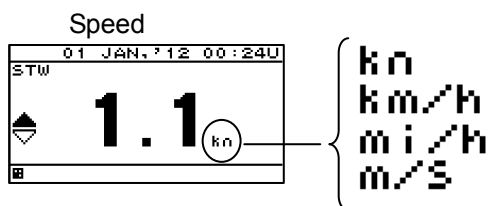



4.6.2. Setting the time difference

You can set the time difference between UTC and local time.

For Japan, the time difference is +9 hours, so you would input +09:00.

When a time difference is set, "L" is displayed on the upper right of the screen.

Procedure

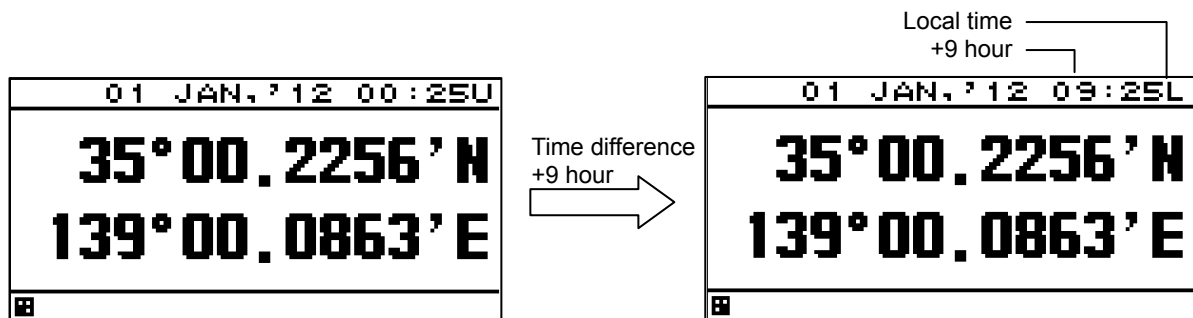

1. Refer to "4.10.1 Changing to a maintenance mode" to display the maintenance menu.
2. Press the  key to select "SYSTEM" and "TIME DIFF" in order.
3. Press the  key to enter the time difference, and press the  key.



4.6.3. Setting date display format

You can set the date display format to “DD MMM,'YY,” “MMM DD,'YY,” or “YY-MMM-DD.”
YY: Year MMM: Month DD: Day

Procedure

1. Refer to “4.10.1 Changing to a maintenance mode” to display the maintenance menu.
2. Press the  key to select “SYSTEM,” “DATE DISP,” and “TIME DISP” in order.
3. Press the  key to select the date display format, and press the  key.

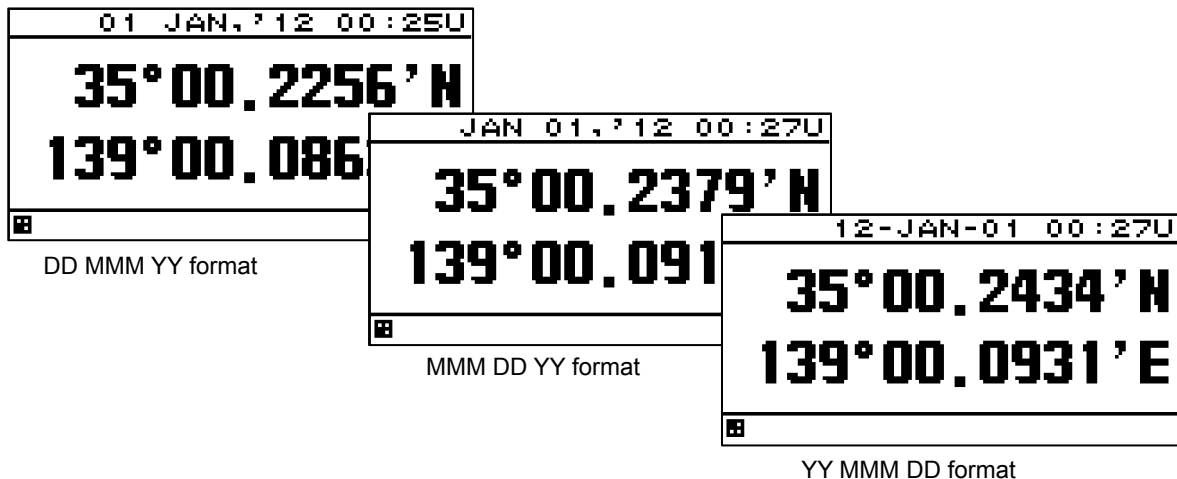

4.6.4. Setting Magnetic Correction

You can set the method of magnetic correction to be automatic or manual, or turn magnetic correction off.



If you select automatic, correction is automatically calculated for the correction value from the GPS position.

If you select manual, correction is performed using a manually entered value.



If you turn magnetic correction off, no correction is performed.

Magnetic compensation can be applied only to a display or an output (usually, carry out the same setup for a display and an output).

Procedure

1. Refer to "4.10.1 Change to a maintenance mode" to display the maintenance menu.
2. Press the  key to select "SYSTEM" and "MAG CORR" in order.
3. Select "DISPLAY" or "OUTPUT."
DISPLAY: The value which carried out magnetic compensation is displayed.
OUTPUT: The value which carried out magnetic compensation is outputted.
4. Press the  key to select correction method, and press the  key.



When Manual is selected

5. Press the  key to enter E/W and correction value, and press the  key.

4.6.5. Displaying as loran c time difference

The latitude and longitude can be displayed as RORAN C time difference.

Procedure

1. Refer to "4.10.1 Changing to a maintenance mode" to display the maintenance menu.
2. Press the  key to select "SYSTEM," "LORAC C," "LORAN C" in order.
3. Press the  key to select "ON."
4. Set the GRI, TD1, TD2, TD1 CORR and TD2 CORR.



4.6.6. Setting transducer position of depth sounder (exclusive to JFE-380/680)

Select which transducer is used to display the measured water depth in the water depth value output from depth sounder JFE-380/680.

This function is used to select the transducer position of the water depth value in the depth sounder screen.

The transducer position that can be selected is Forward "FWD," Medium "MID," and Backward (AFT). For detail screen, refer to page 2-3.

Procedure

1. Refer to "4.10.1 Changing to a maintenance mode" to display the maintenance menu.
2. Press the  key to select "SYSTEM," "DEPTH," and "TRANS" in order.
3. Press the  key to enter the transducer position, and press the  key.



4.6.7. Setting water depth offset of depth sounder

You can set an offset in the received water depth value.

The offset that can be set is ± 99.9 m.

When an offset is set, the received water value with the offset value added is displayed.

Procedure

1. Refer to “4.10.1 Changing to a maintenance mode” to display the maintenance menu.
2. Press the  key to select “SYSTEM,” “DEPTH,” and “OFFSET” in order.
3. Press the  key to enter an offset, and press the  key.

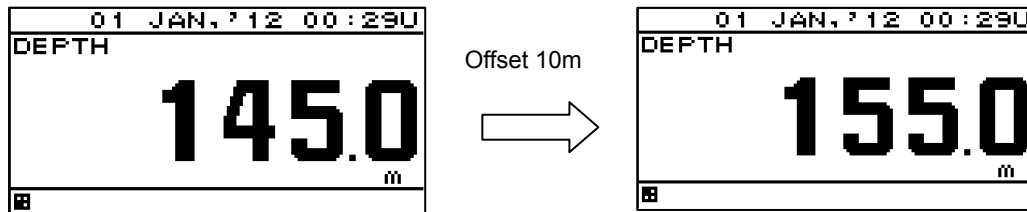



4.7. Language Settings

You can set the display language to nine languages

(English/Japanese (katakana)/German/French/Italian/Norwegian/Spanish/Vietnamese/Indonesian).

To change the language, place the unit in the maintenance mode.

Procedure

1. Refer to “4.10.1 Changing to a maintenance mode” to display the maintenance menu.
2. Press the  key to select “LANG” and “LANG” in order.
3. Press the  key to select the language, and press the  key.

4.8. Alarm Settings

Selecting “ALARM” on the main menu displays the alarm setting screen.

When the set alarm occurs, the pop-up and the alarm icon “” on the status bar alert the occurrence of an alarm as well as the buzzer sounds. The screen lighting color can also be changed.

Pressing the  key stops pop-up, buzzer sound, and screen lighting, but the icon continues

To stop the buzzer sound, press the  key the number of times alarm occurs, appearing until the alarm has been resolved.

The unit must be placed in maintenance mode to change the alarm settings.

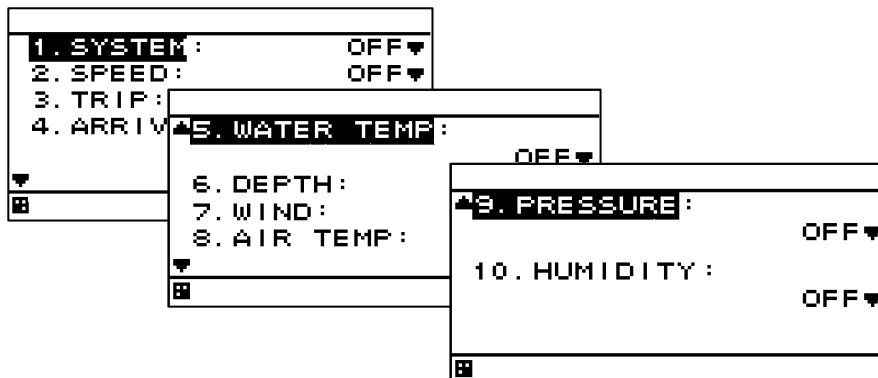

The following alarms can be configured.

- 1) SYSTEM: An alarm occurs when the system error occurs.
 - 2) SPEED: An alarm occurs when the ship speed matches the set parameters.
 - 3) TRIP: An alarm occurs when the distance matches the set parameters.
 - 4) ARRIVAL: An alarm occurs when own ship reaches the arrival circle radius.
 - 5) WATER TEMP: An alarm occurs when the water temperature matches the set parameters.
 - 6) DEPTH: An alarm occurs when the water depth matches the set parameters.
 - 7) WIND: An alarm occurs when the wind velocity matches the set parameters.
 - 8) AIR TEMP: An alarm occurs when the air temperature matches the set parameters.
 - 9) PRESSURE: An alarm occurs when the atmosphere matches the set parameters.
 - 10) HUMIDITY: An alarm occurs when the humidity matches the set parameters.
- When alarms are set to OFF, the alarm settings are cleared.

The alarm sound and screen brightness color when an alarm occurs can be set.

- 1) SOUND
ON: The buzzer sounds when an alarm occurs.
OFF: The buzzer does not sound when an alarm occurs.
- 2) LCD COLOR
ON: The screen brightness color changes when an alarm occurs.
OFF: The screen brightness color does not change when an alarm occurs.

If normal brightness color is set to white, it becomes orange, and vice versa.

4.8.1. Setting the alarm range

An alarm occurs when the range is set and the value matches the set range.

You can select the range from OVER, UNDER, IN RANGE, and OUT RANGE depending on the alarm.

OVER: An alarm occurs when the value exceeds the set value.

UNDER: An alarm occurs when the value falls below the set value.

IN RANGE: An alarm occurs when the value is within the set range.

OUT RANGE: An alarm occurs when the value is outside the set range.

When setting the IN RANGE and OUT RANGE, set the upper limit and lower limit values.

When an alarm is set to OFF, alarm settings are cleared.

The alarm types and alarm range that can be set are as follows.

Alarm type	Alarm range				
	OVER	UNDER	IN RANGE	OUT RANGE	OFF
SYSTEM	—	—	—	—	○
SPEED	○	○	○	○	○
TRIP	○	—	—	—	○
WATER TEMP	○	○	○	○	○
DEPTH	○	○	○	○	○
WIND	○	—	—	—	○
AIR TEMP	○	○	○	○	○
PRESSURE	○	○	○	○	○
HUMIDITY	○	○	○	○	○

○: Can be set.

Procedure

1. Refer to “4.10.1 Changing to a maintenance mode” to display the maintenance menu.
2. Press the  key to select “ALARM” and “ALARM TYPE” in order.
3. Set the alarm according to the alarm setting procedure.



4.8.2. Setting a system alarm

An alarm occurs when the system error occurs.

The following is an overview of the system error.

- 1) The data can not be received.
- 2) The data is invalid.

Procedure





1. Refer to “4.10.1 Changing to a maintenance mode” to display the maintenance menu.
2. Select “ALARM” and “SYSTEM” in this order by using .
3. Select “ON” or “OFF” by using  and press .
4. Refer to “4.8.12 Setting a buzzer sound and screen back light” to set the alarm sound and screen brightness.

4.8.3. Setting a vessel speed alarm

When the vessel speed reaches the set range, the alarm is issued.
The range can be selected from OVER, UNDER, IN RANGE, and OUTRANGE.

- OVER: An alarm is issued when the vessel speed reaches or exceeds the set speed.
UNDER: An alarm is issued when the vessel speed is equal to or slower than the set speed.
IN RANGE: An alarm is issued when the vessel speed is between the lower limit value and the upper limit value.
OUT RANGE: An alarm is issued when the vessel speed is equal to or slower than the lower limit value or equal to or higher than the upper limit value.
For IN RANGE and OUT RANGE, set the upper limit value and lower limit value.





Procedure

1. Refer to "4.10.1 Changing to a maintenance mode" to display the maintenance menu.
2. Select "ALARM" and "SPEED" in this order by using .
3. Select "OVER", "UNDER", "IN RANGE", or "OUT RANGE" by using .
4. Select "OVER", "UNDER", "MAXIMUM" or "MINIMUM" by using .
5. Enter a vessel speed by using  and press .
6. Refer to "4.8.12 Setting a buzzer sound and screen back light" to set the alarm sound and screen brightness.

4.8.4. Setting a TRIP alarm

An alarm is issued when the distance exceeds the set TRIP.



Procedure

1. Refer to "4.10.1 Changing to a maintenance mode" to display the maintenance menu.
2. Select "ALARM" and "TRIP" in this order by using .
3. Select "OVER" by using .
4. Select "OVER" by using .
5. Enter a distance by using  and press .
6. Refer to "4.8.12 Setting a buzzer sound and screen back light" to set the alarm sound and screen brightness.

4.8.5. Setting a ARRIVAL alarm

An alarm is issued when the own ship reaches the arrival circle.
To use the arrival alarm function, the APB sentence is necessary.





Procedure

1. Refer to "4.10.1 Changing to a maintenance mode" to display the maintenance menu.
2. Select "ALARM" and "ARRIVAL" in this order by using .
3. Select "ARRIVAL" by using  and press .
4. Refer to "4.8.12 Setting a buzzer sound and screen back light" to set the alarm sound and screen brightness.

4.8.6. Setting the water temperature alarm

An alarm occurs when the water temperature exceeds the set value.





Procedure

1. Refer to “4.10.1 Changing to a maintenance mode” to display the maintenance menu.
2. Press the  key to select “ALARM” and “WATER TEMP” in order.
3. Press the  key to select “OVER,” “UNDER,” “IN RANGE,” or “OUT RANGE.”
4. Press the  key to select “OVER,” “UNDER,” “MAXIMUM,” or “MINIMUM.”
5. Press the  key to enter the water temperature, and press the  key.
6. Refer to “4.8.12 Setting a buzzer sound and screen back light” to set the alarm sound and screen brightness.

4.8.7. Setting the water depth alarm

An alarm occurs when the water depth exceeds the set value.





Procedure

1. Refer to “4.10.1 Changing to a maintenance mode” to display the maintenance menu.
2. Press the  key to select “ALARM” and “DEPTH” in order.
3. Press the  key to select “OVER,” “UNDER,” “IN RANGE,” or “OUT RANGE.”
4. Press the  key to select “OVER,” “UNDER,” “MAXIMUM,” or “MINIMUM.”
5. Press the  key to enter the water depth, and press the  key.
6. Refer to “4.8.12 Setting a buzzer sound and screen back light” to set the alarm sound and screen brightness.

4.8.8. Setting the wind velocity alarm

An alarm occurs when the wind velocity exceeds the set value.





Procedure

1. Refer to “4.10.1 Changing to a maintenance mode” to display the maintenance menu.
2. Press the  key to select “ALARM” and “WIND” in order.
3. Press the  key to select “OVER.”
4. Press the  key to select “OVER.”
5. Press the  key to enter the wind velocity, and press the  key.
6. Refer to “4.8.12 Setting a buzzer sound and screen back light” to set the alarm sound and screen brightness.

4.8.9. Setting the air temperature alarm

An alarm occurs when the air temperature exceeds the set value.





Procedure

1. Refer to “4.10.1 Changing to a maintenance mode” to display the maintenance menu.
2. Press the  key to select “ALARM” and “AIR TEMP” in order.
3. Press the  key to select “OVER,” “UNDER,” “IN RANGE,” or “OUT RANGE.”
4. Press the  key to select “OVER,” “UNDER,” “MAXIMUM,” or “MINIMUM.”
5. Press the  key to enter the air temperature, and press the  key.
6. Refer to “4.8.12 Setting a buzzer sound and screen back light” to set the alarm sound and screen brightness.

4.8.10. Setting the atmosphere alarm

An alarm occurs when the atmosphere exceeds the set value.





Procedure

1. Refer to “4.10.1 Changing to a maintenance mode” to display the maintenance menu.
2. Press the  key to select “ALARM” and “PRESSURE” in order.
3. Press the  key to select “OVER,” “UNDER,” “IN RANGE,” or “OUT RANGE.”
4. Press the  key to select “OVER,” “UNDER,” “MAXIMUM,” or “MINIMUM.”
5. Press the  key to enter the atmosphere, and press the  key.
6. Refer to “4.8.12 Setting a buzzer sound and screen back light” to set the alarm sound and screen brightness.

4.8.11. Setting the humidity alarm

An alarm occurs when the humidity exceeds the set value.

Procedure

1. Refer to “4.10.1 Changing to a maintenance mode” to display the maintenance menu.
2. Press the  key to select “ALARM” and “HUMIDITY” in order.
3. Press the  key to select “OVER,” “UNDER,” “N RANGE,” or “OUT RANGE.”
4. Press the  key to select “OVER,” “UNDER,” “MAXIMUM,” or “MINIMUM.”
5. Press the  key to enter the humidity, and press the  key.
6. Refer to “4.8.11 Setting a buzzer sound and screen back light” to set the alarm sound and screen brightness.

4.8.12. Setting a buzzer sound and screen back light





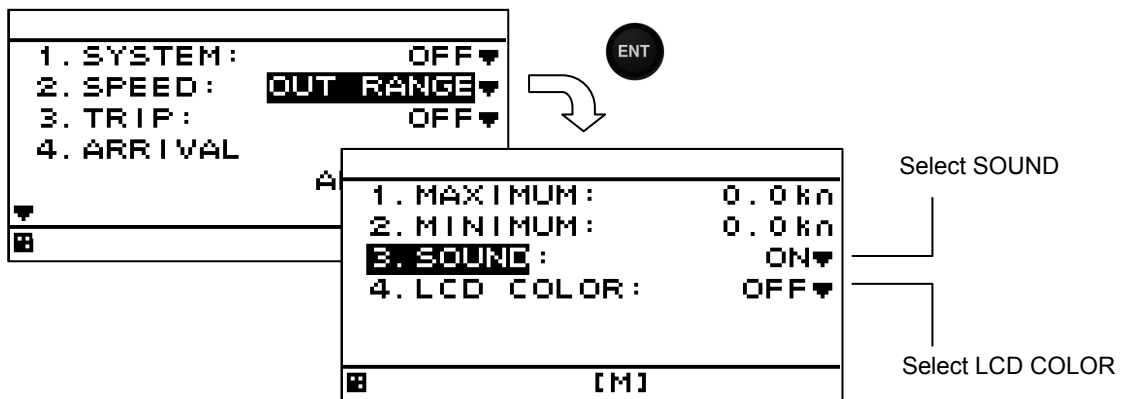

An alarm sound and the color of the screen back light at the occurrence of an alarm can be set. When the back light color under the normal condition is set to white, the color is changed to orange and when the back light color is set to orange, the color is changed to white.

- 1) SOUND ON: When an alarm occurs, the buzzer sound is emitted.
 OFF: Even if an alarm occurs, the buzzer sound is not emitted.
- 2) LCD COLOR ON: When an alarm occurs, the back light color of the screen is changed.
 OFF: Even if an alarm occurs, the back light color of the screen is not changed.

Procedure

1. Refer to "4.10.1 Changing to a maintenance mode" to display the maintenance menu.





2. Select "SOUND" by using .
3. Select "ON" or "OFF" by using  and press .
4. Select "LCD COLOR" by using .
5. Select "ON" or "OFF" by using  and press .

4.9. Beacon Information

The beacon information (Type16 message) from the beacon broadcast stations can be displayed. To display the beacon information, the PJRC,GP,8 sentence is necessary.



Procedure

1. Refer to "4.15.1 Change to a maintenance mode" to display the maintenance menu.
2. Press the  key to select "BEACON."
3. Press the  key to select "ON." and press the  key.

4.10. Setting Installation

After completing the installation that is described in Chapter 6, check the operation and set the details. In the installation setting, implement the following operations according to the system specification of the vessel.



- 1) Changing to a maintenance mode
- 2) Setting a model
- 3) Selecting a dimmer unit
- 4) Setting dimmer control linkage and data sharing
 - Setting RS-485ID
 - Setting a dimmer group
 - Setting data sharing
- 5) Setting the display screen
- 6) Setting daisy chain

4.10.1. Changing to a maintenance mode

Before starting installation, the mode must be changed to a maintenance mode to prevent an operation error.

Change the mode to a maintenance mode by the initial operation.

Procedure

1. Display a main menu by pressing  (normal mode).
2. Press  and  for 3 seconds.
3. The menu is changed to a maintenance menu (maintenance mode).
When the mode is changed to a maintenance mode, the [M] icon is displayed at the bottom of the screen.

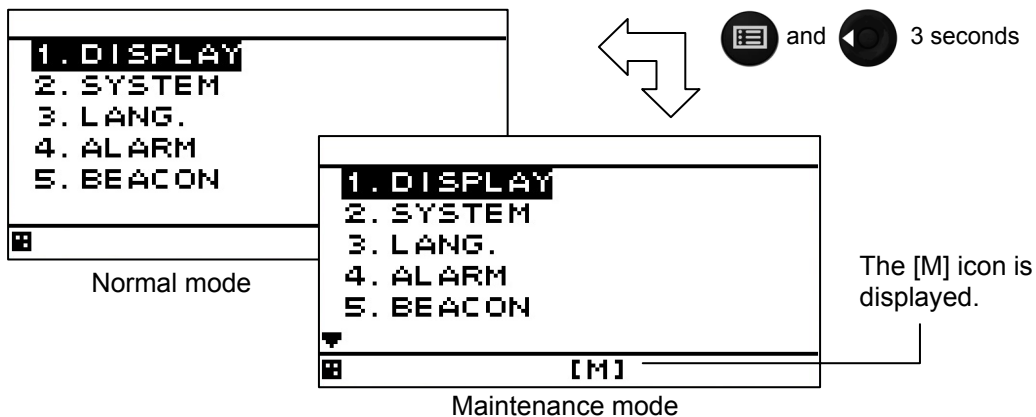



Figure 4.1 Transition of menu screens

● Returning to a normal mode





When  and  are pressed for 3 seconds or no operation is performed for 3 minutes, the mode is reset to a normal mode.

When the power is turned on, the system starts in normal mode.

4.10.2. Setting a model

This display unit is set in the MID display unit.
When the model is set, the setting contents are initialized.

Procedure

1. Refer to "4.10.1 Changing to a maintenance mode" to display the maintenance menu.
2. Select "12.DISPLAY TYPE" by using  and press .
3. Select "MID" by using  and press .
4. When the following popup menu is displayed, press "YES".
When "NO" is selected, the model setting is cancelled.

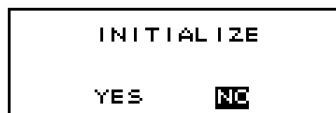

Caution

- When "LOG" is selected wrong, the following messages appears.

After the messages appears, press  and  for 8 seconds. The message is canceled.

Then, select "MID" again in the previous procedure.

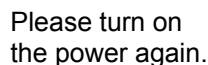

Please turn on
the power again.

- Don't turn off the power supply until the "INITIALIZING" disappears.

4.10.3. Selecting a dimmer unit



Specify whether an external dimmer unit (NCM-227) or a dimmer key is used for controlling the dimmer unit of this display unit.

When an external dimmer unit is used, the contact input must be set to "DIMMER". For the setting method, see "4.10.6. Setting a contact port".

When sharing a dimmer unit, set the same dimmer unit for the display units that share the dimmer unit. Unless the same dimmer unit is set, linking cannot be performed.

To calibrate the external dimmer unit, refer to "7.1 Calibration of External dimmer unit" in service manual.

Procedure

1. Refer to "4.10.1 Changing to a maintenance mode" to display the maintenance menu.
2. Select "DIMMER" by using .
3. Select a dimmer unit by using  and press .

4.10.4. Dimmer linked control and data sharing with RS-485

By connecting display units with RS-485 network, dimmer control can be linked and data can be shared.

To connect display units with RS-485 network, the display units must be identified by setting RS-485ID in each display unit.

Up to 10 display units can be connected.

The same baud rate must be set for all the display units. Normally, the baud rate is set to 115200bps.

It is possible to select key control or control by an external dimmer unit for dimmer control. Display units that are linked can be selected by classifying display units under dimmer control into groups.

However, the same control method such as key control or control using an external dimmer unit must be applied among the display units that are linked. Up to 10 groups are allowed.

Data can be shared by outputting a NMEA sentence to the RS-485 network.

By sharing data, the same data can be displayed.

To output data, the data must be received from the external unit.

A typical connection example for implementing dimmer control and data sharing with RS-485 is shown below. Refer to the setting reference section for the setting method.

The connection conditions of the connection example are as follows.

		Display unit 1	Display unit 2	Display unit 3	Display unit 4	Setting reference section
RS-485ID		1	2	3	4	4.10.4.1
Dimmer control unit		External dimmer unit	External dimmer unit	Dimmer key	Dimmer key	4.10.3
Dimmer group		1	1	2	2	4.10.4.3
Input data	RS-422	-	-	-	Vessel speed	4.10.5.2
	RS-485	Vessel speed	Vessel speed	Vessel speed	-	-
Output data	RS-485	-	-	-	Vessel speed	4.10.4.4
Baud rate [bps]		115200	115200	115200	115200	4.10.4.4
Screen display		Vessel speed	Vessel speed	Vessel speed	Vessel speed	4.10.4

In this example, dimmer control of ID1 and that of ID2 are linked by the external dimmer unit and dimmer control of ID3 and ID4 are not linked.

Dimmer control of ID3 and that of ID4 are linked by key operation and dimmer control of ID1 and that of ID2 are not linked.

By transmitting vessel data that is input from ID4 through the RS-485 network, vessel speed data can be displayed on all the display units.

Connection example

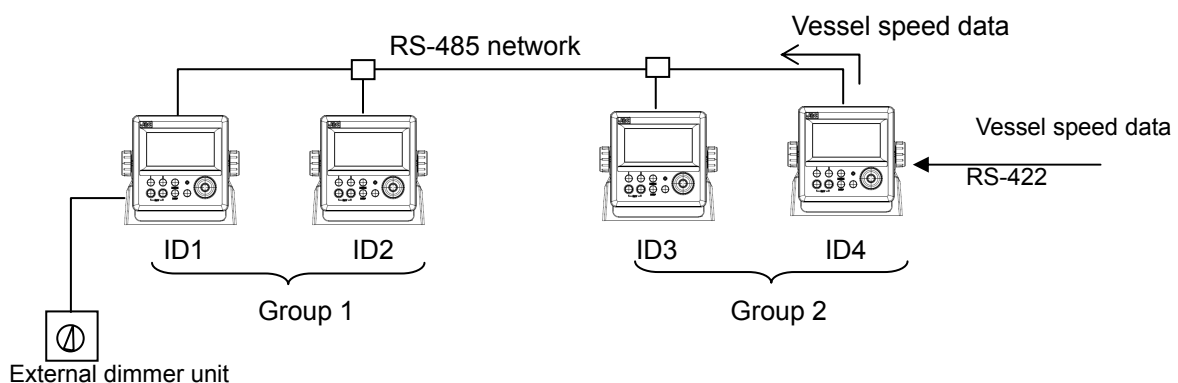

4.10.4.1. Setting RS-485ID



To identify a display unit on the RS-485 network, set an ID for each display unit.

To use RS-485, an ID must be set.

Avoid duplication of ID among the display units. Otherwise, data and dimmer linkage are not possible.

Available IDs are from 1 to 10.

Procedure

1. Refer to “4.10.1 Changing to a maintenance mode” to display the maintenance menu.
2. Select “RS-485ID” by using .
3. Enter an ID number by using  and press .

4.10.4.2. Linking dimmer control

Dimmer control linkage is available for the display units that are connected by the RS-485 network.

The following conditions are necessary for the linkage.

- 1) The display units must be connected by RS-485.
- 2) The same dimmer control is used.
- 3) The display units are in the same dimmer group.

Set the details by referencing the following sections.

- 1) Set RS-485ID by referencing “4.10.4 1 Setting RS-485ID”.
- 2) Select the same dimmer unit by referencing “4.10.3 Selecting a dimmer unit”.
- 3) Set the display units in the same dimmer group by referencing “4.10.4.3 Setting a dimmer group”.
To disable linkage of dimmer control even though the display unit is connected by the RS-485 network, change the dimmer group.

Caution

Since dimmer data is transmitted between display units, some time lag may occur at dimmer switching.

4.10.4.3. Setting a dimmer group



Set a group within which dimmer control for this display unit is linked.

Available dimmer group numbers are from 1 to 10.

Set a dimmer group when the display units for which dimmer control is to be linked need to be grouped due to the different equipment environment even though the units are connected by RS-485.

Select the same dimmer unit within the same group. Otherwise, dimmer control cannot be linked within the group.

Procedure

1. Refer to “4.10.1 Changing to a maintenance mode” to display the maintenance menu.
2. Select “DIMMER GROUP” by using .
3. Enter a group number by using  and press .

4.10.4.4. Sharing data

Data can be shared among the display units that are connected through the RS-485 network. Set the data to be transmitted. Although setting for reception is not necessary, the baud rate must be standardized among the display units.

For the linkage, set RS-485ID by referencing "4.10.4.1 Setting RS-485ID".

Setting transmission

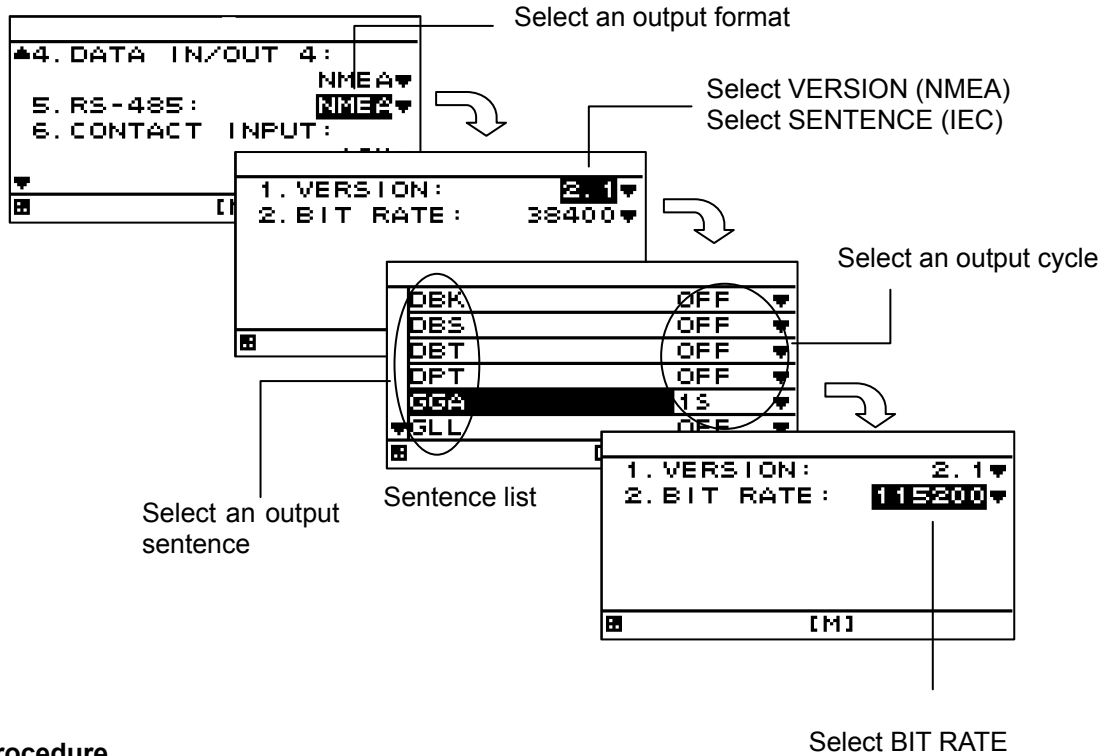

Procedure

1. Refer to "4.10.1 Changing to a maintenance mode" to display the maintenance menu.
2. Select "INTERFACE", "DATA I/O", and "RS-485" in this order by using .
3. Select the output format to be set by using .
- 1) Selecting NMEA
4. When an output version is selected by using , a sentence list is displayed.
Available versions are "1.5", "2.1", "2.3", and "4.0".
5. Select an output sentence by using and set an output cycle.
A cycle can be selected within the range from 1 second to 9 seconds and if OFF is selected, the sentence is not output.
6. Return control to the BIT RATE selection screen and select BIT RATE by using .
- Available bit rates are "38400", "57600", "76800", and "115200". Normally, "115200" is recommended.
- 2) Selecting IEC
- In IEC, VERSION is not selected.
4. When "SENTENCE" is selected by using , a sentence list is displayed.
5. Select an output sentence by using and set an output cycle.
A cycle can be selected within the range from 1 second to 9 seconds and when OFF is selected, the sentence is not output.

6. Return control to the BIT RATE selection screen and select BIT RATE by using . Available bit rates are “38400”, “57600”, “76800”, and “115200”. Normally, “115200” is recommended.

Caution

Since data is transmitted between display units, some time lag occurs at the switching of display.

4.10.5. Setting a serial port

This display unit is equipped with three serial ports to send and receive data with external units. Since each port can be set for input or output, set according to the purpose. However, as input/output of data IN/OUT1 and data IN/OUT2 are commonly set, they cannot be set individually. For instance, if data IN/OUT2 is set for input, data IN/OUT1 is automatically set for input. In this case also, the baud rate and the output sentence can be set individually. Determine the input output ports using the following table as the guideline.

Required port setting	Port setting		
	Data IN/OUT1	Data IN/OUT2	Data IN/OUT3
3 ports for output	Output	Output	Output
3 ports for input	Input	Input	Input
2 ports for output 1 port for input	Output	Output	Input
1 port for output 2 ports for input	Input	Input	Output

Although an output sentence, a cycle, and a bit rate can be set for each port, some bit rates and the number of sentences may not be set. In this case, select the minimum sentence.

The following serial data can be set.







- 1) NMEA: Data is output in NMEA format. Available options are Version 1.5, 2.1, 2.3, and 4.0.
- 2) IEC: Data is output in IEC format.
- 3) JRC: Data is output in JRC format. Bit rate is fixed 1200bps.

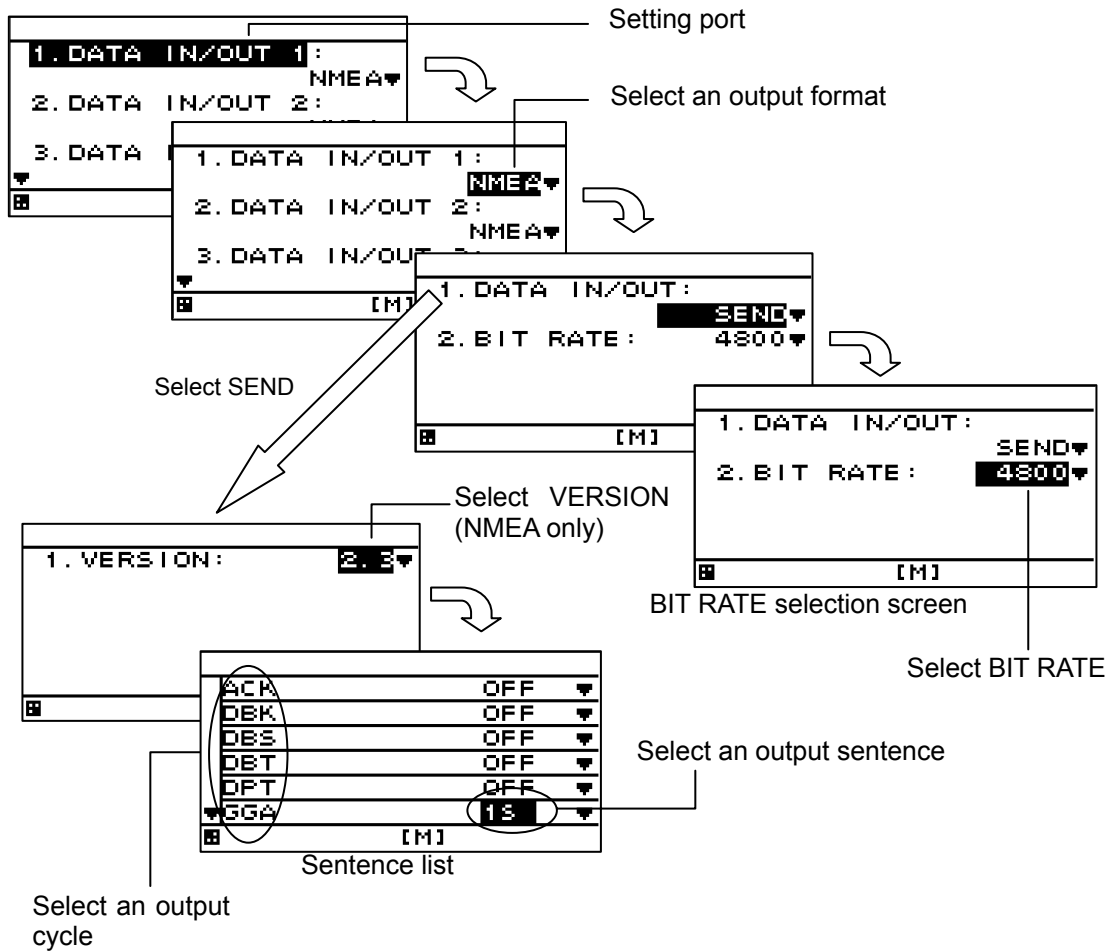



4.10.5.1. Setting transmission

The procedure for setting a serial port for transmission is shown below.

Procedure



1. Refer to "4.10.1 Changing to a maintenance mode" to display the maintenance menu.
 2. Select "INTERFACE" and "DATA I/O" in this order by using .
 3. Select the output format to be set by using .
 - 1) Selecting NMEA
 4. Select "SEND" from "DATA IN/OUT" by using .
 5. When an output version is selected by using , a sentence list is displayed.
Available versions are "1.5", "2.1", "2.3", and "4.0".
 6. Select an output sentence by using  and set an output cycle.
A cycle can be selected within the range from 1 second to 9 seconds and if OFF is selected, the sentence is not output.
 7. Return control to the BIT RATE selection screen and select BIT RATE by using .
- Available bit rates are "4800", "9600", "19200", and "38400".

- 2) Selecting IEC
For IEC, there is no need to select VERSION.
 4. Select "SEND" from "DATA IN/OUT" by using .
 5. Select an output sentence by using  and set an output cycle.
The cycle can be selected within the range from 1 second to 9 seconds and when OFF is selected, the sentence is not output.
 6. Return control to the BIT RATE selection screen and select BIT RATE by using .
Available bit rates are "4800", "9600", "19200", and "38400".
-
- 3) Selecting JRC
 4. Select "INTERVAL" and "4s" by using .
A cycle can be selected only 4 seconds and if OFF is selected, the sentence is not output.
The JRC format can not be select version, bit rate and sentence.
The bit rate is fixed 1200bps.

Supplement

When the "SEND" or "RECEIVE" of data IN/OUT1 or data IN/OUT2 is set and one port is set, the other port is also set concurrently. The message that is shown below is displayed to prevent the unintentional setting of the other port. When setting a port, select "YES". If "NO" is selected, the port is not set.

```
SET DATA
IN/OUT 1AND2 OK?
YES    NO
```

4.10.5.2. Setting reception

In the reception setting, set a bit rate.
There is no need to set a sentence or a cycle.

Procedure

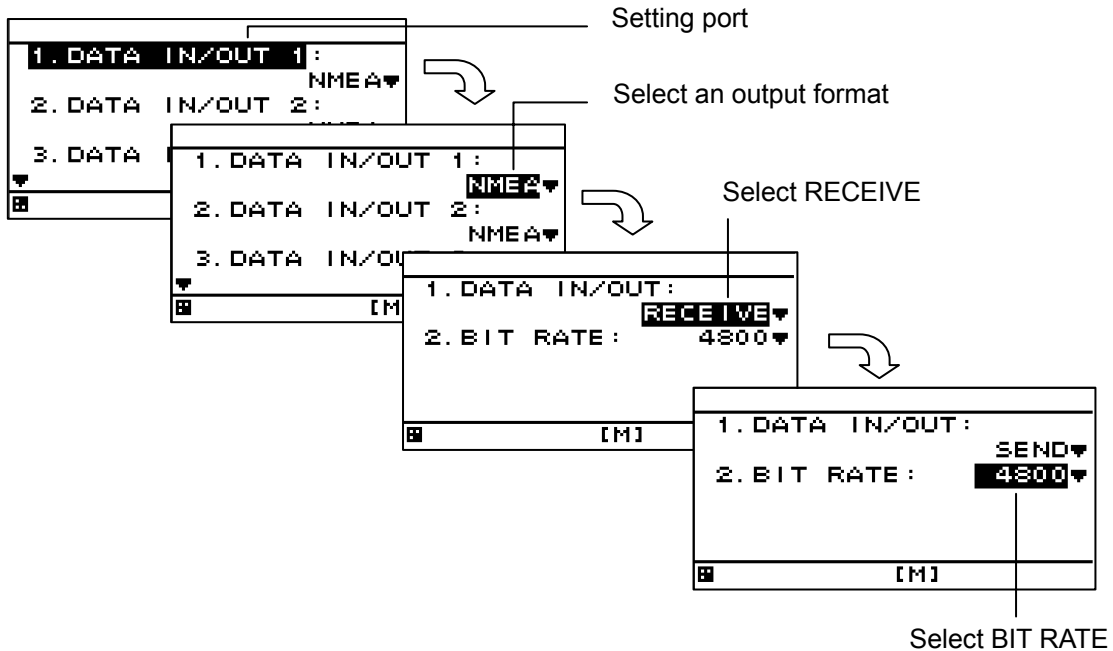

1. Refer to “4.10.1 Changing to a maintenance mode” to display the maintenance menu.
 2. Select “INTERFACE” and “DATA I/O” in this order by using
 3. Select a port and a format that are to be set by using
 4. Select “RECEIVE” from “DATA IN/OUT” by using
 5. Select “BIT RATE” by using
- Available bit rates are “4800”, “9600”, “19200”, and “38400”.

Supplement

When the “SEND” or “RECEIVE” of data IN/OUT1 or data IN/OUT2 is set and one port is set, the other port is also set concurrently. The message that is shown below is displayed to prevent the unintentional setting of the other port. When setting a port, select “YES”. If “NO” is selected, the port is not set.

```
SET DATA
IN/OUT 1AND2 OK?
YES NO
```

4.10.6. Setting a contact port



4.10.6.1. Setting a contact input port

A contact input port can be set to the following input.

- 1) DIMMER: Use this option when connecting an external dimmer unit.
- 2) ACK: Alarm ACK is input from an external unit.

To use an external dimmer unit, the dimmer unit must be set to "EXT DIMMER". See "4.10.3 Selecting a dimmer unit" for the setting method.



Procedure

1. Refer to "4.10.1 Changing to a maintenance mode" to display the maintenance menu.
2. Select "INTERFACE", "DATA I/O" and "CONTACT INPUT" in this order by using .
3. Select an item to be input by using  and press .

4.10.6.2. Setting a contact output port

A contact output port can be set to the 400Pluse/NM or 200Pluse/NM input.

Procedure

1. Refer to "4.10.1 Changing to a maintenance mode" to display the maintenance menu.
2. Select "INTERFACE", "DATA I/O" and "CONTACT OUTPUT" in this order by using .
3. Select an item to be input by using  and press .

4.10.7. Outputting alarm history



Alarm history can be output to an external unit.

Data is output from a data IN/OUT1 port.

If data IN/OUT1 is set to reception, the port must be set to transmission.

Connect PC to a serial port before output operation.

Procedure

1. Refer to "4.10.1 Changing to a maintenance mode" to display the maintenance menu.
2. Set DATA IN/OUT to "SEND" by referencing "4.10.5 Setting a serial port".
3. Select "INTERFACE" and "DIAGNOSIS" in this order by using .
4. When  is pressed at "ERROR LOG OUTPUT", data is output to an external unit.

Supplement

When DATA IN/OUT1 is used by setting to transmission, port setting is not required. At completion of alarm history, the setting is reset to the original output data automatically.

4.10.8. Checking installation

Installation can be checked.

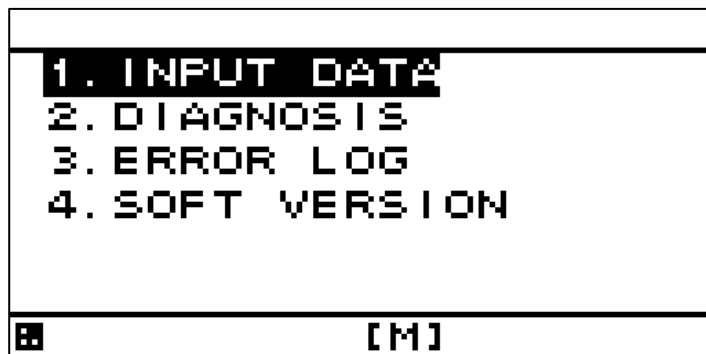

The following items can be checked.

- 1) Checking the input port
- 2) Self-diagnosis
- 3) Display of alarm history
- 4) Confirmation of software version and serial number







Supplement

- See "4.10.7 Outputting alarm history" for external output of alarm history.
- See "4.10.15 Outputting Setting value" for external output of setting value.
- See "4.10.14 Demonstration" for setting a demo mode for confirmation of data output.

4.10.9. Checking the input port

Data that is received from the input port can be displayed on a screen.
The input port and display format (ASCII/BINARY) can be selected.
Data of the port that is set to output cannot be displayed.

Procedure

1. Refer to “4.10.1 Changing to a maintenance mode” to display the maintenance menu.
2. Select “MAINTENANCE” and “INPUT DATA” in this order by using  and press .
An operation description screen is displayed as shown below.
3. To change the display format press . The format changes between ASCII and BINARY.
4. Select the port whose data is to be displayed by using  and press . The received data is displayed on the screen. To cancel the display press  again.
During cancellation, the blinking of the * mark is stopped.





When no data is displayed, check the connection and the setting of the serial port.

4.10.10. Self-diagnosis

Self-diagnosis of the display unit can be performed and the result can be displayed.
The following items can be diagnosed.

- 1) ROM, RAM, and serial port of the display unit
- 2) Screen LCD
The entire screen is highlighted repeatedly such as black to white, white to black.
Check if some dots are omitted.
- 3) Buzzer sound
Checks if the buzzer sounds.

Procedure



1. Refer to “4.10.1 Changing to a maintenance mode” to display the maintenance menu.
2. Select “MAINTENANCE” and “DIAGNOIS” in this order by using .
3. Select a diagnosis item by using  and press . The diagnosis is executed and the result is displayed.

If you wish to stop the Screen LCD check, press .



4.10.11. Displaying an alarm

The current alarm and past alarms can be displayed. Up to 40 past alarms can be stored and when the number of alarms exceeds 40, alarms are deleted from the oldest one.

Procedure

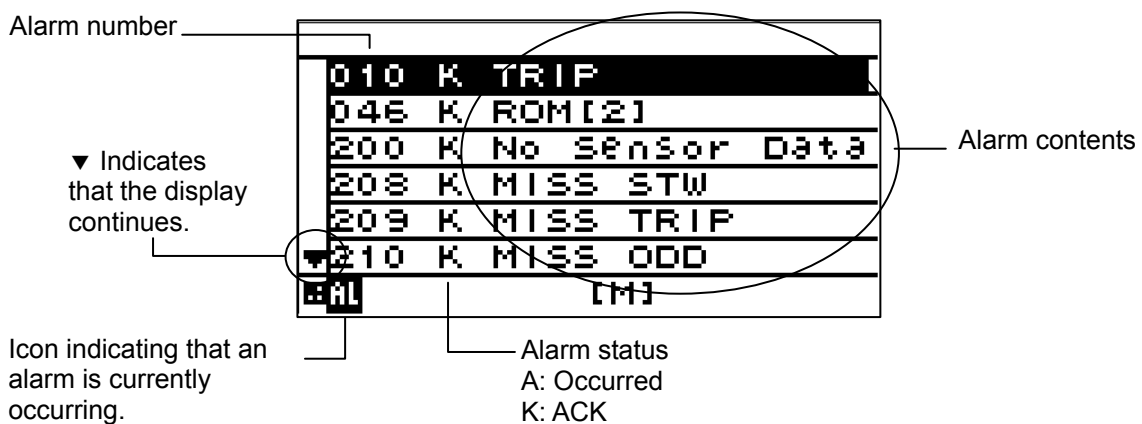
1. Refer to “4.10.1 Changing to a maintenance mode” to display the maintenance menu.
 2. Select “MAINTENANCE” and “ERROR LOG” in this order by using .
 - Displaying the current alarm
 3. Select “ALARM” by using  and press .
- The current alarm is displayed.
When no alarm has occurred, no information is displayed.



- Displaying past alarm history1
4. Press “ERROR LOG” by using  and press .

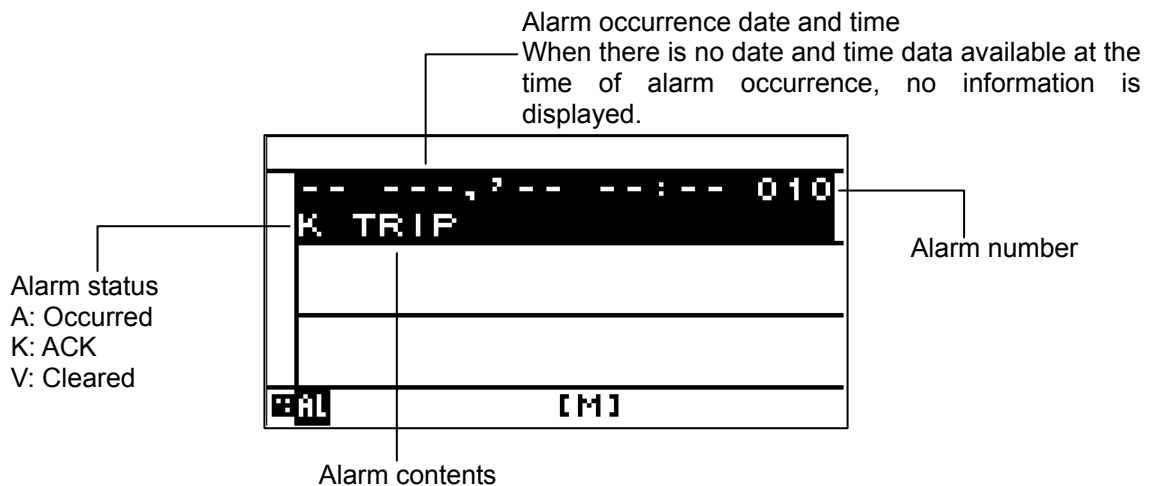

4.10.12. Displaying the software version

The software version, serial number and bar code number of the display unit can be displayed.

Procedure

1. Refer to “4.10.1 Changing to a maintenance mode” to display the maintenance menu.
2. Select “MAINTENANCE”, “SOFT VERSION”, and “DISPLAY VER” in this order by using .

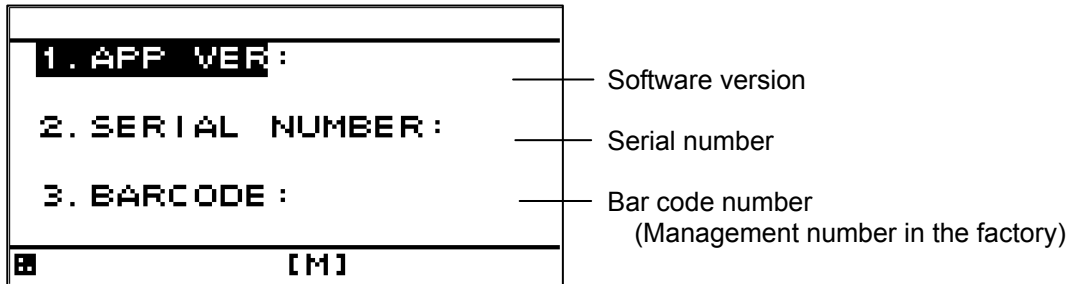

4.10.13. Performing master reset

This section describes how to perform master reset of the equipment.

Reset of water temperature and water depth



Reset of entire display unit

When master reset is performed, the setting values are reset to the default values. It is recommended to keep the records of the setting values before performing master reset.

However, the following items are not reset.

Model, RS-485ID, daisy chain setting, dimmer control unit setting, dimmer group



Procedure

1. Refer to “4.10.1 Changing to a maintenance mode” to display the maintenance menu.
2. Select “MASTER RESET” by using  and press .

4.10.14. Demonstration

Through a demonstration, display and external output are enabled in the same way as the actual equipment operation.

Procedure

1. Refer to “4.10.1 Changing to a maintenance mode” to display the maintenance menu.
2. Select “DEMO MODE” and “DEMO TYPE” in this order by using .
3. Select a DEMO condition and press .
4. Select "DEMO MODE" and "START" by using .



Supplement

During execution of demonstration, [S] is displayed in blinking mode at the bottom of the screen. To end demonstration, set “DEMO MODE” to “END” or turn off the power.

4.10.15. Outputting setting value

Setting value can be output to an external unit.
Data is output from a data IN/OUT1 port.
If data IN/OUT1 is set to reception, the port must be set to transmission.
Connect PC to a serial port before output operation.

Procedure

1. Refer to “4.10.1 Changing to a maintenance mode” to display the maintenance menu.
2. Set DATA IN/OUT to “SEND” by referencing “4.10.5 Setting a serial port”.
3. Select “INTERFACE” and “DIAGNOSIS” in this order by using .
4. When  is pressed at “CONFIG OUTPUT”, data is output to an external unit.





Supplement

When DATA IN/OUT1 is used by setting to transmission, port setting is not required. At completion of alarm history, the setting is reset to the original output data automatically.

4.10.16. Setting the current to be displayed

You can set the layer and data No. to be displayed.
The layer that can be displayed is up to three layers from the top.
Normally, set “LAYER” for use.

Procedure

1. Refer to “4.10.1 Changing to a maintenance mode” to display the maintenance menu.
2. Press the  key to select “CURRENT.”
3. Press the  key to select “LAYER,” and press the  key.
4. Press the  key to select “DATA No.,” and press the  key.



4.11. Setting daisy chain

The power can be distributed to up to three units from one power supply by setting daisy chain. The display units in the same dimmer group can share the dimmer. Power is not supplied to the fourth and subsequent units.
ON: Power is supplied to the next MID for daisy-chaining.
OFF: Power is not supplied to the next MID.

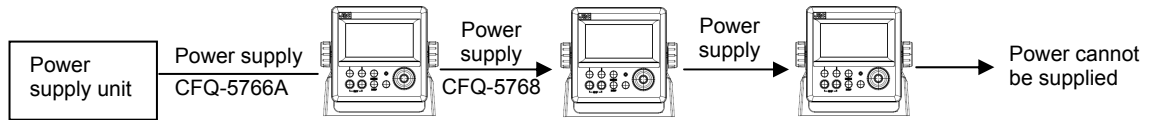
When output a data by daisy chain, set the "DATA IN/OUT4".



Procedure

1. Refer to “4.10.1 Changing to a maintenance mode” to display the maintenance menu.
2. Press the  key to select “DAISY CHAIN.”
3. Press the  key to select ON/OFF, and press the  key.

Caution

- Be aware that when the MID fails or the power is turned off if the power is supplied in daisy-chain mode, power cannot be supplied to the subsequent MID.
- When the power is supplied in daisy-chain mode, the display unit closer to the power supply starts to be activated, so it takes time for the second and subsequent display unit to be activated.
- When the "DAISY CHAIN" is set to "ON", "DATA IN/OUT1" is set automatically to "SEND", also "DATA IN/OUT3" is set automatically to "RECEIVE". Although it can be switched over with manual, it recommends that reception connection from an external unit uses "DATA IN/OUT3".

Chapter 5 Maintenance

WARNING



Do not check or repair in this unit. Please call our field representative or your nearest JRC office for inspection and repair services. Otherwise it may cause a fire or an electric shock.



Do not remove the cover of this unit. Otherwise, you may touch a high-voltage part and suffer from an electric shock.



Turn off the power on/off switch, and turn off the power supply breaker when you check this unit for maintenance. Otherwise, a fire, an electric shock, or a failure may occur.



Do not disassemble or modify this unit. Otherwise, a fire, an electric shock, or a failure may occur.



In the event that you spill or drop any liquids or metals etc., turn off the unit, turn off the power supply breaker, and contact your sales agent outlet or one of JRC branch offices, sales centers or liaison offices. Continuing operation may cause a fire, an electric shock or a malfunction.



In the event that smoking or burning odors are detected, immediately terminate operation of the unit and contact your sales agent outlet or one of JRC branch offices, sales centers or liaison offices. Never attempt to check or repair the unit. Continuing operation may cause a fire or an electric shock.

CAUTION



Do not use an organic solvent such as thinner or benzene when you clean the surface of the unit. For cleaning the surface, remove the dust and wipe with clean dry cloth. Otherwise, the painting on the surface may be damaged.

5.1. Daily Maintenance



WARNING



Do not remove the cover of this unit. Otherwise, you may touch a high-voltage part and suffer from an electric shock.



Turn off the power on/off switch, and turn off the power supply breaker when you check this unit for maintenance. If an electric shock. Otherwise, a fire, an electric shock, or a failure may occur.

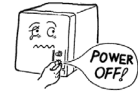

CAUTION



Do not use an organic solvent such as thinner or benzene when you clean the surface of the unit. For cleaning the surface, remove the dust and wipe with clean dry cloth. Otherwise, the painting on the surface may be damaged.

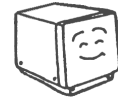

The life of the device depends on how daily maintenance and inspection are performed carefully. To keep the device in the best condition at all times, it is recommendable to perform periodical inspections constantly. Any failure in the device can be prevented before it occurs through such inspections. Please perform the inspections shown in the table below periodically.

- Remove stains from the panel face, knob, panel keys, top cover by wiping them lightly with dry cloth.
- Check knob, panel keys, loosening of the connector and starting the omission, and it tightens correctly.
- Check loosening and rattling of the screw bolt that is the fixation of the case, and it tightens surely.
- Operate the equipment under standard power voltage levels (DC 10.8 - 31.2 V).

5.2. Alarm

Refer to "4.10.11 Displaying an alarm" and check if any alarm is given or not. If it is, check the details referring to the list shown below.

Alarm List

Message Number	Message Contents	Alarm Causes
2/3/7	SOG/STW/SOG(LOG)	Speed alarm occurs
10	TRIP	Trip alarm occurs
12	Arrival Wpt	Arrival at waypoint
17	WATER TEMP	Water Temperature alarm occurs
18	DEPTH	Depth alarm occurs
19/20	TWS/AWS	Wind alarm occurs
21	AIR TEMP	Air temperature occurs
22	PRESSURE	Pressure alarm occurs
23	HUMIDITY	humidity alarm occurs
45	ROM[1]	Flash ROM Deletion, Write Error (ROM[1])
46	ROM[2]	Flash ROM Deletion, Write Error (ROM[2])
47	ROM[3]	SEEPROM Deletion, Write Error
48	RAM	RAM Read, Write Error
49	SIO[0]	Serial Port Error (SIO[0])
50	SIO[1]	Serial Port Error (SIO[1])
51	SIO[2]	Serial Port Error (SIO[2])
52	SIO[3]	Serial Port Error (SIO[3])
53	SIO[6]	Serial Port Error (SIO[6])
-	No Sensor Data	Sensor periodic input not possible (No data)
-	Sensor Data Invalid	Sensor information unobtainable (Position, Time, Course, etc.)

5.3. Troubleshooting for Malfunctions or Abnormalities

WARNING



In the event that smoking or burning odors are detected, immediately terminate operation of the unit and contact your sales agent outlet or one of JRC branch offices, sales centers or liaison offices. Never attempt to check or repair the unit. Continuing operation may cause a fire or an electric shock.

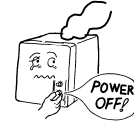

The following is reference information concerning identification of problems.

Symptom	Possible Causes	Troubleshooting Measures
The power does not turn on when the power switch is pressed.	Power is not being supplied by the ship junction box.	Check whether the cabling from the junction box is normal.
	Power is not being supplied by the power supply equipment (option).	Check whether the power supply unit cabling is normal.
	The fuse connected to the power cable has blown.	If there are no problems in the cabling, replace the fuse.
	The power supply equipment (option) fuse has blown.	If there are no problems in the cabling, replace the fuse.
	The display unit switch is broken.	Consult with JRC or our agents.
The LCD display does not display anything.	The LCD display is broken.	Consult with JRC or our agents.
The display does not light up.		
The alarm sound is not generated.	The buzzer is broken.	Consult with JRC or our agents.
	The alarm sound is turned off.	Refer to 4.8.11
The click does not sound.	The key press sound is turned off.	Refer to 4.5.3
There is no reception (from sensor).	The sensor connection cable is disconnected.	Check the connection cable.
	The sensor is broken.	Consult with JRC or our agents.
There is no transmission (to external devices).	Output settings have not been configured.	Refer to 4.10.5
	The configured channel is incorrect.	Refer to 6.3.1
	The DISP-DPU or POWER SUPPLY UNIT is broken.	Consult with JRC or our agents.
The Dimmer are not interlocked.	The baud rate is different.	Refer to 4.10.4.4
	The dimmer group is different.	Refer to 4.10.4.3
	The dimmer is different.	Refer to 4.10.3
	The cable is disconnected.	Check the connection.
Data is not shared.	The baud rate is different.	Refer to 4.10.4.4
	Output sentence is not selected.	Refer to 4.10.4.4
	The cable is disconnected.	Check the connection.

5.4. Repair Unit

5.4.1. Repair unit

Repair units and their models are shown below.

No	Name	Model	Notes
1	DSP UNIT	CMJ-562	
2	POWER UNIT	CMP-490	
3	LCD UNIT	CCN-423	

FUSE

No	Name	Model	Notes
1	FUSE	MF60NR 250V 1	for Data power cable 1A FUSE

Mechanical Parts

No	Name	Code	Notes
1	FRONT PANEL KIT	MPBC47673	FRONT PANEL PRODUCT NAMEPLATE

5.4.2. Regular Replacement Parts

Parts which should be regularly replaced are shown below.
Contact JRC or an affiliate to order.

No	Name	Model	Life	Notes
1	LCD UNIT	CCN-423	40000 hours	Approximately 5 years of continuous use

Chapter 6 Installation



CAUTION



Consult with JRC or our agents to install. Installation by unauthorized personnel may result in a malfunction.



Do not install this unit at the place exposed to direct sunlight for a long time or hit by hot wind or where the temperature rises above 55°C. Otherwise it may cause a fire or a breakdown.



Do not put the equipment on the unstable place such as wobbly base or tilted area. Otherwise it may cause the equipment to drop or fall, resulting in an injury or a failure.



Do not put the equipment in the cabinet or cover it with the nonporous thing such as cardboard. Otherwise it may cause the equipment to be filled with heat, resulting in a fire or a failure.



When this unit is suddenly moved from a cool place to a warm place, dew condensation water may form on the inside windows, and the liquid crystal part can become visually difficult. In this case, leave the unit for a while until becoming dry condition. Then operate the unit.

6.1. Affixing Display Unit Nameplate Labels

6.1.1. Affixing product nameplate

Peel the label of the equipment to be used from the accessory product nameplate, and affix it to the center of the front panel.

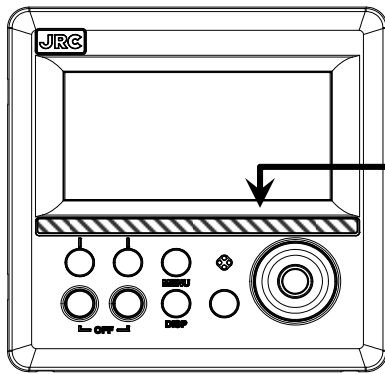

Display Unit Front

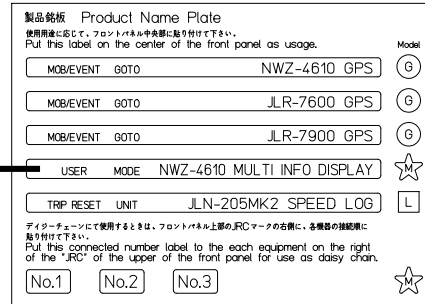

Product Nameplate (Accessory)

6.1.2. Affixing model identification plate

Peel the label of the equipment to be used from the accessory model identification plate, and affix it over the upper left blank part of the unit nameplate at the center of the rear case.

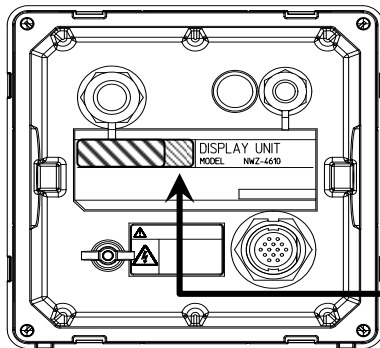

Display Unit Rear

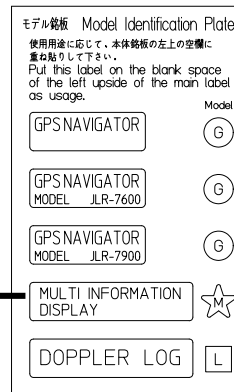

Model Identification Plate (Accessory)

After affixing model identification plate

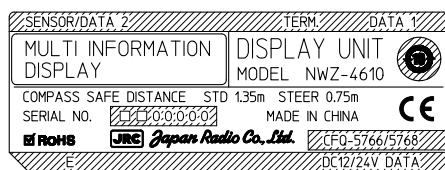

6.2. Display Unit Installation

6.2.1. Selecting the position for installation

WARNING



Install this unit at least 1 m away from any magnetic compasses. Installation near a magnetic compass may interfere with the magnetic compass, resulting in an accident.



Do not use this unit at the voltage other than its rated voltage. Otherwise it may result in a fire, an electric shock or a failure.

CAUTION



Use the indicated screws when installing the display unit to a stable woodensurface. Otherwise it may cause the display to fall down, resulting in an injury or a property damage.



During installation, be sure to connect the earth plate and earth cable to the earth terminal. Otherwise it may cause an electric shock in case of failure or electric leak.



Do not use or leave the equipment at the place exposed to direct sunlight or hit by hot wind for a long time or where the temperature becomes 55°C or higher. Otherwise it may cause a fire or a failure.



Do not put the equipment on the unstable place such as wobbly or tilted area. Otherwise it may cause the equipment to drop or fall, resulting in a fire or a failure.



Do not put the equipment in the cabinet or cover it with the nonporous thing such as cardboard. Otherwise it may cause the equipment to be filled with heat, resulting in a fire or a failure.



Use the proper power cable, signal cable, and earth cable. Otherwise it may cause this unit to damage t other equipment.

6.2.2. Mounting the display unit using a rack

Use the following procedure.

- (1) Fix the desktop rack at the required installation position by using the mounting screws ($\phi 4\sim 6$ screw or wood screw, $L\geq 15\text{mm}$, provided by the shipyard).
- (2) Insert the front panel into the main unit.
- (3) Attach the rotational washer on the side of the main unit.
- (4) Attach the rotational washer on the side of the desktop rack.
- (5) Assemble the main unit on the desktop rack, insert the knob metal washer between the desktop rack and the knob bolt, and fix the main unit by tightening the knob bolts.

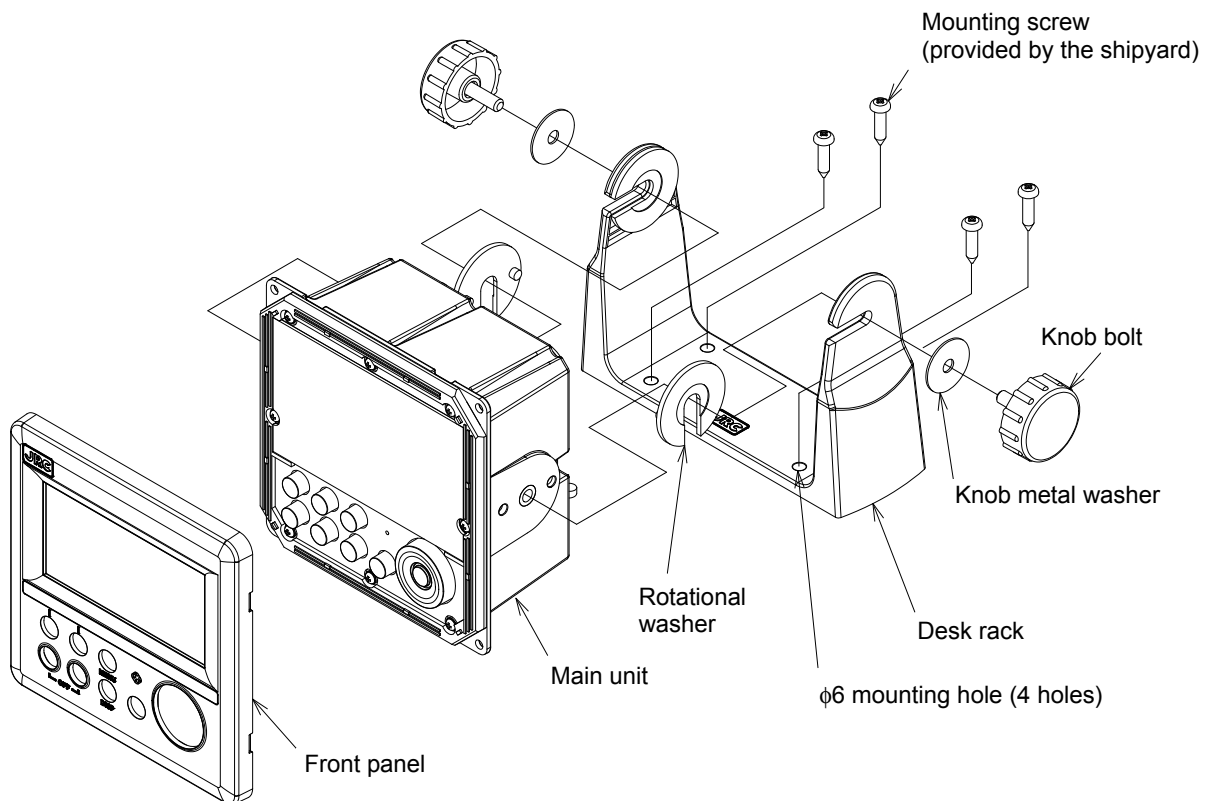

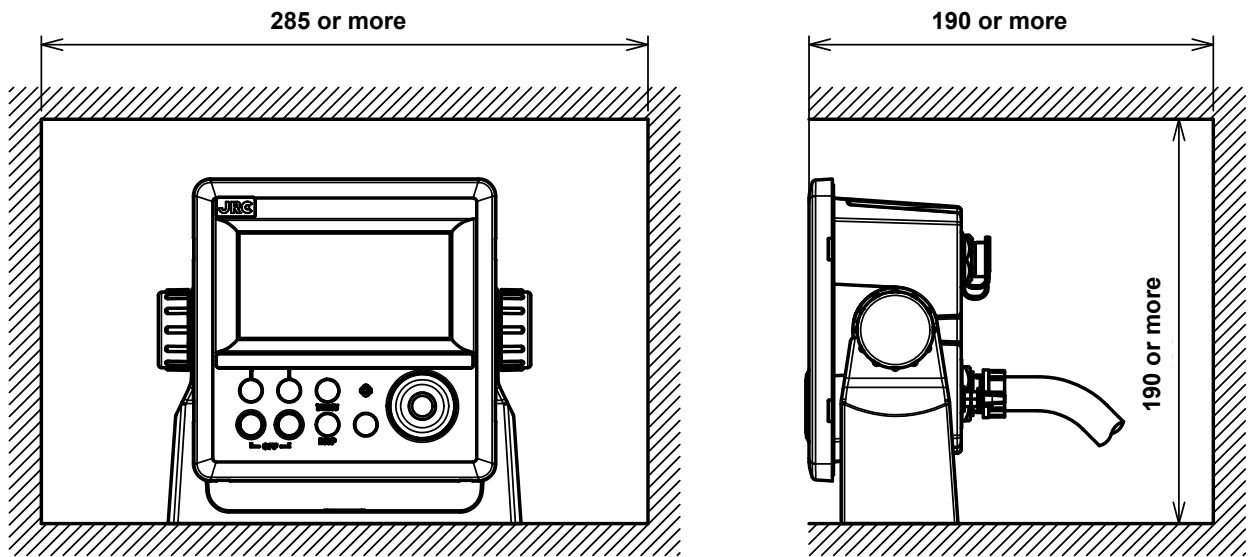

Required installation space

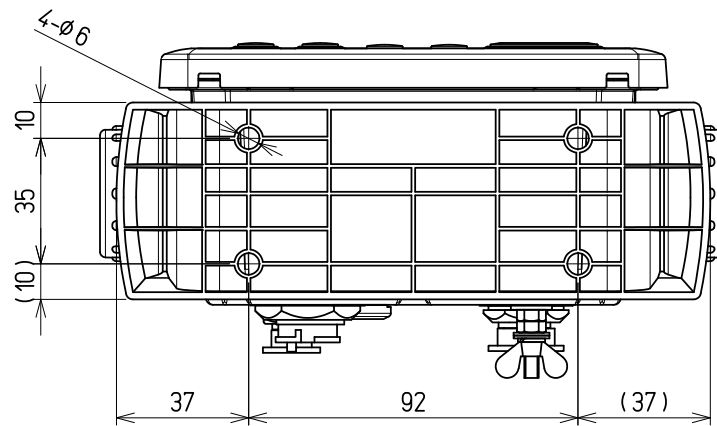

Mount (bottom)

(Unit: mm)

6.2.3. Mounting using a flash mount

Use the following procedure.

See the diagram below for the mounting space and mounting holes.

Do not tighten a screw too much. Doing so may result in damage of installation holes.

- (1) Insert the main unit in the installation location (L10mm or more).
- (2) Fix the main unit using the mounting screws ($\phi 4$ screw or wood screw, $L \geq 10$ mm, provided by the shipyard).

The sizes of the heads of the screws that are used are restricted as follows including the washers.

- Diameter: Up to $\phi 8$ mm
- Height: Up to 4.5 mm

- (3) Insert the front panel into the main unit

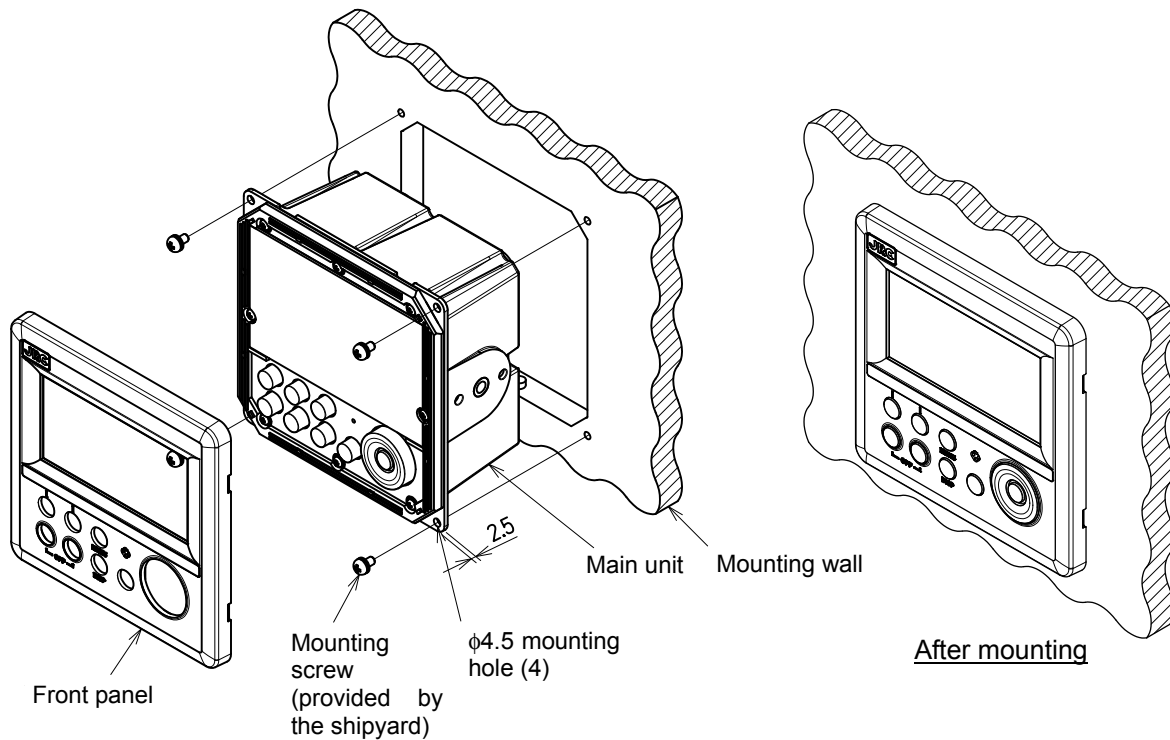

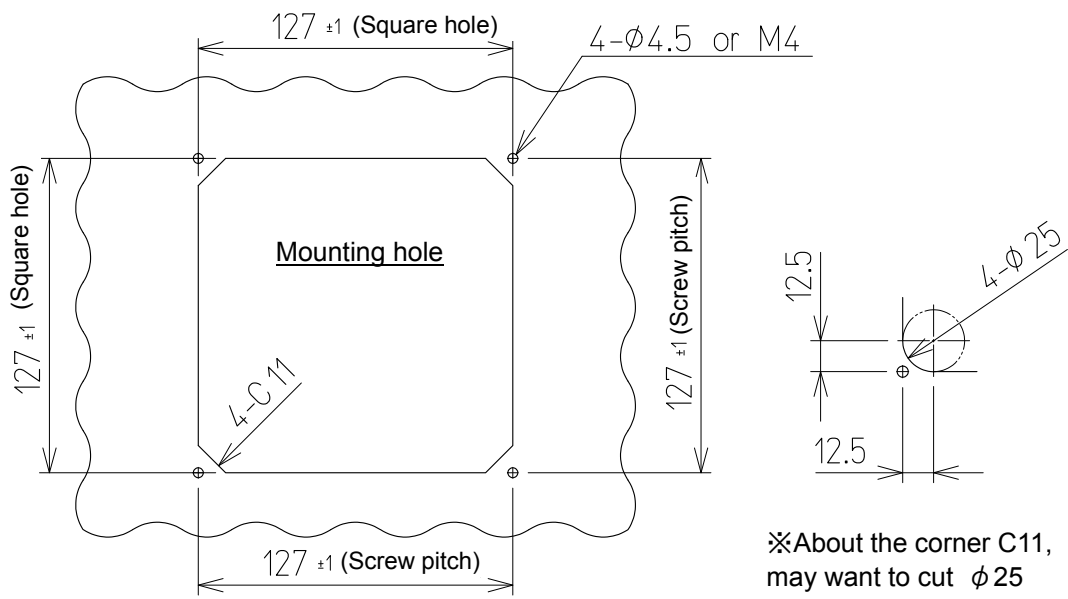
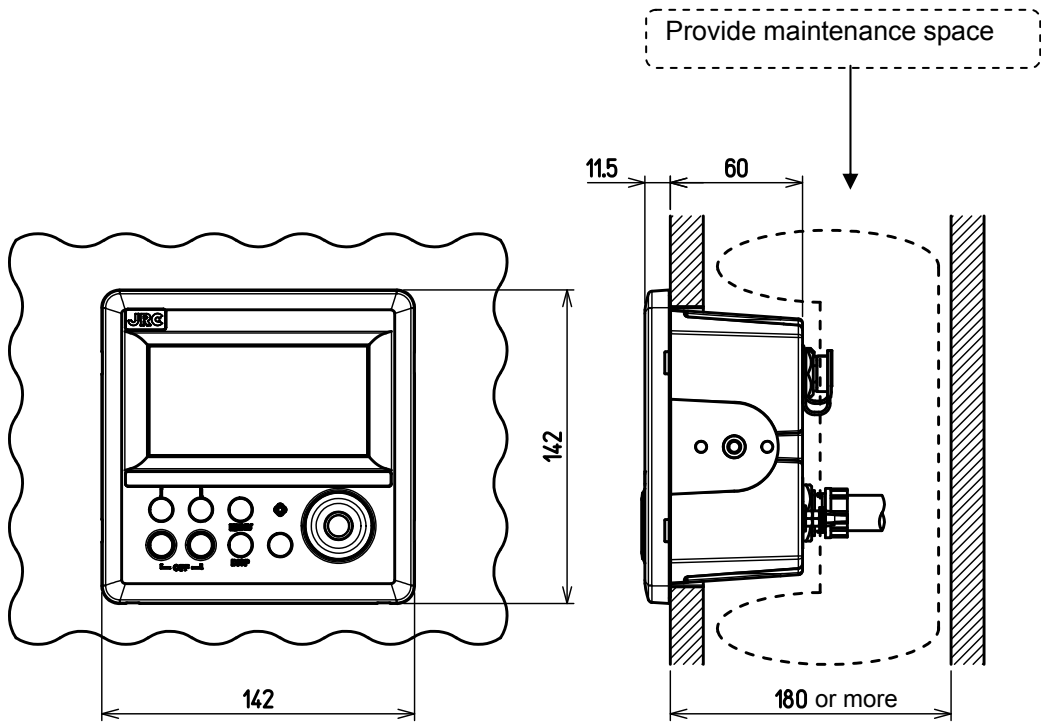

6.2.4. Removing the display unit by flash mounting

Use the following procedure to remove the display unit.

- (1) Insert a hexagonal wrench into the holes (2) at the bottom of the front panel.
- (2) Remove the front panel by pressing down the hexagonal wrench.

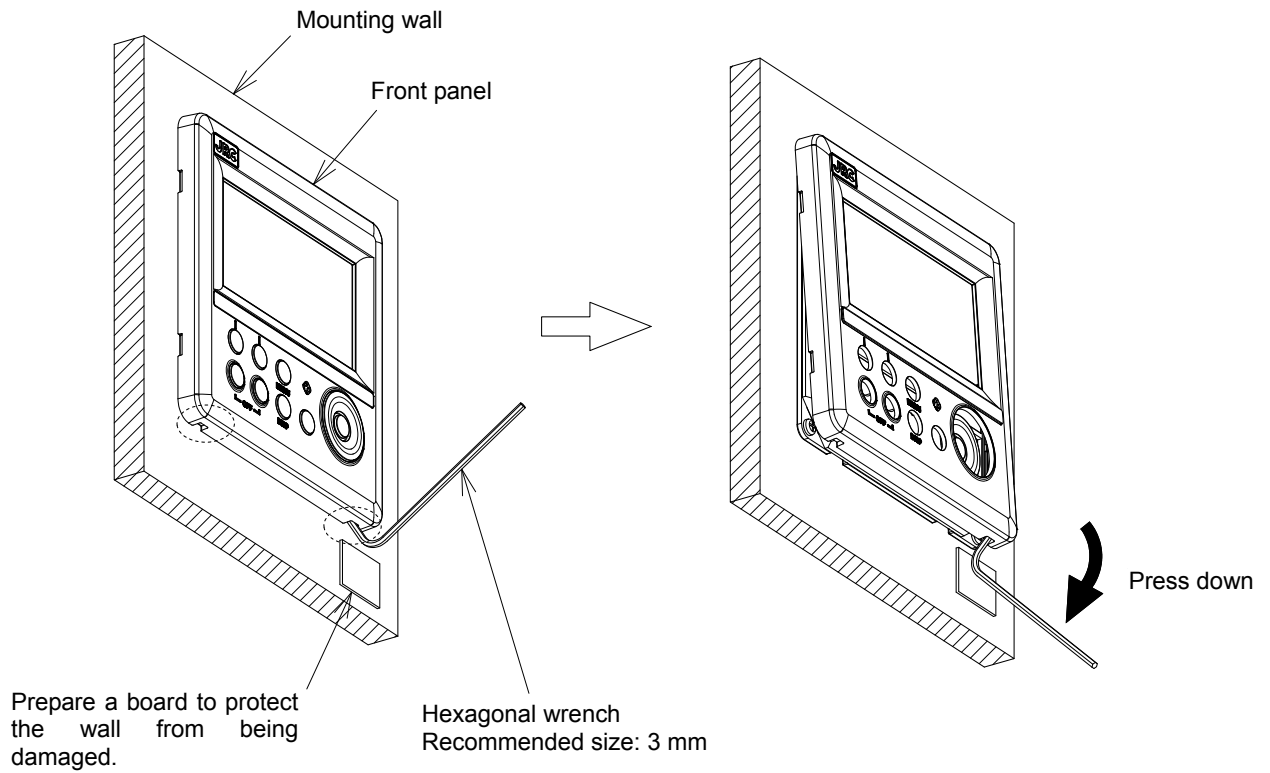

6.3. Cable Connection

● Unit (Rear Connector)

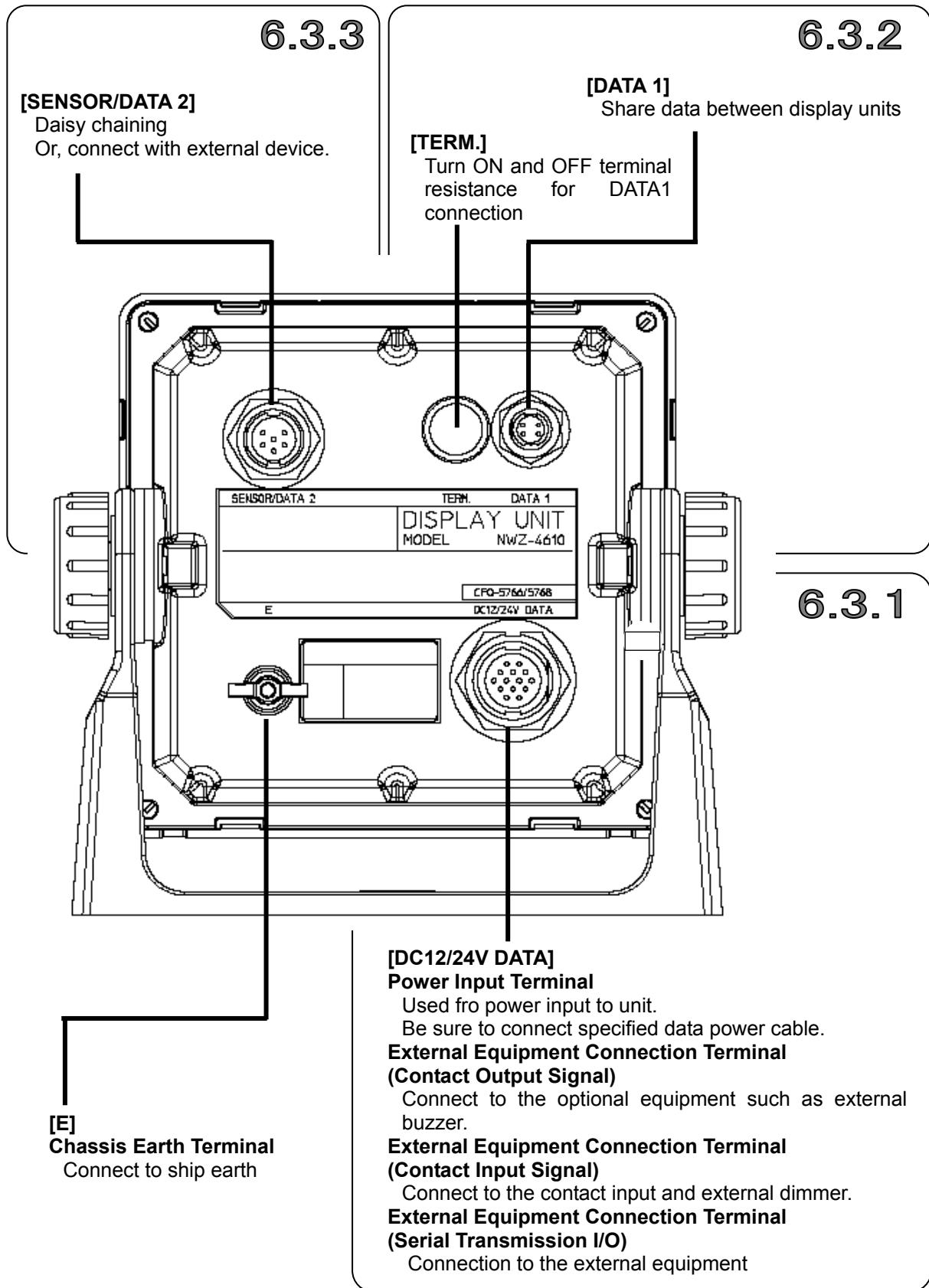

6.3.1. DC12/24V DATA connector

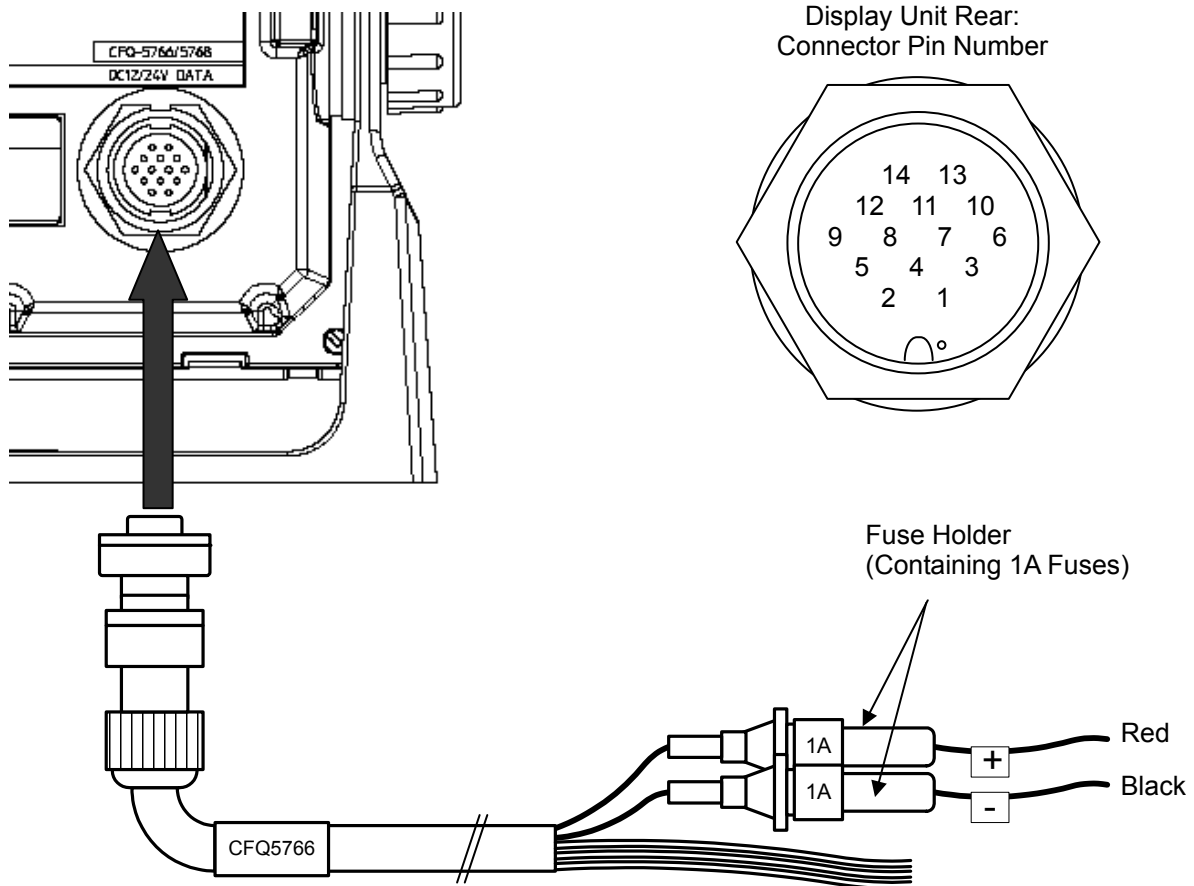

Data Power Cable
 CFQ-5766A: 2 m (Accessory)
 CFQ-5766D: 10 m (Option)
 CFQ-5766F: 20 m (Option)

Terminal Number (CFQ-5766)		Name	Explanation
1	Red	DC12/24V	DCIN +
2	Black		DCIN -
3	Orange	Contact Output	ALM_COM
4	Yellow		ALM_NO
5	Green		ALM_NC
6	Blue	Contact Input	ACK_IN+
7	Purple	Analog Input	ACK_IN-
8	Gray	Serial Transmission (DATA I/O 1)	SD0-A
9	White		SD0-B
10	Pink	Serial Transmission (DATA I/O 2)	SD3-A
11	Sky blue		SD3-B
12	Bright green	Serial Transmission (DATA I/O 3)	SD6-A
13	Brown		SD6-B
14	Black (Shield)	Chassis Earth	E

[Input/Output Condition for Serial Transmission]

The data power cable (CFQ-5766) has three serial transmission channels.

The input/output settings for DATA I/O "1" and "2" are linked to each other. As listed below, four connections and settings can be made.

For the input/output settings for channels, see "4.10.5 Setting a serial port".

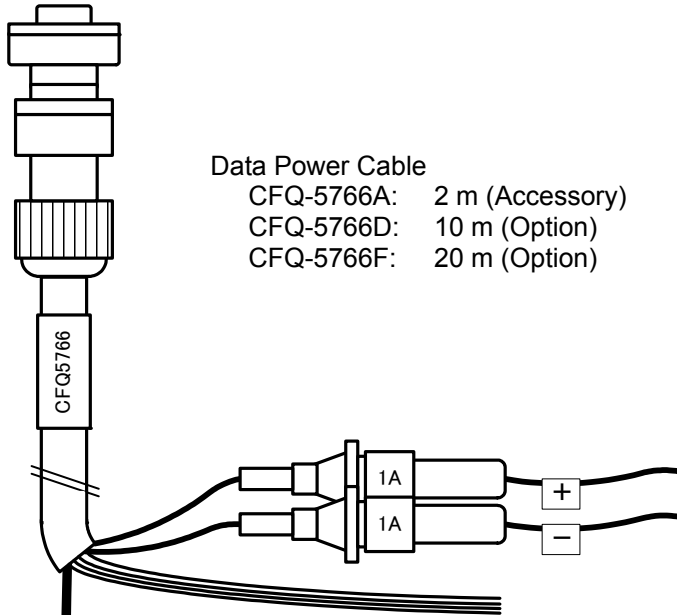

Data Power Cable
 CFQ-5766A: 2 m (Accessory)
 CFQ-5766D: 10 m (Option)
 CFQ-5766F: 20 m (Option)

Terminal Number (CFQ-5766)		Name		Input/Output Condition			
				3ch Input	2ch Input 1ch Output	1ch Input 2ch Output	3ch Output
8	Gray	Serial Transmission (DATA I/O 1)	SD0-A	Input	Input	Output	Output
9	White		SD0-B				
10	Pink	Serial Transmission (DATA I/O 2)	SD3-A	Input	Input	Output	Output
11	Sky blue		SD3-B				
12	Bright green	Serial Transmission (DATA I/O 3)	SD6-A	Input	Output	Input	Output
13	Brown		SD6-B				

[Input/Output Circuit]

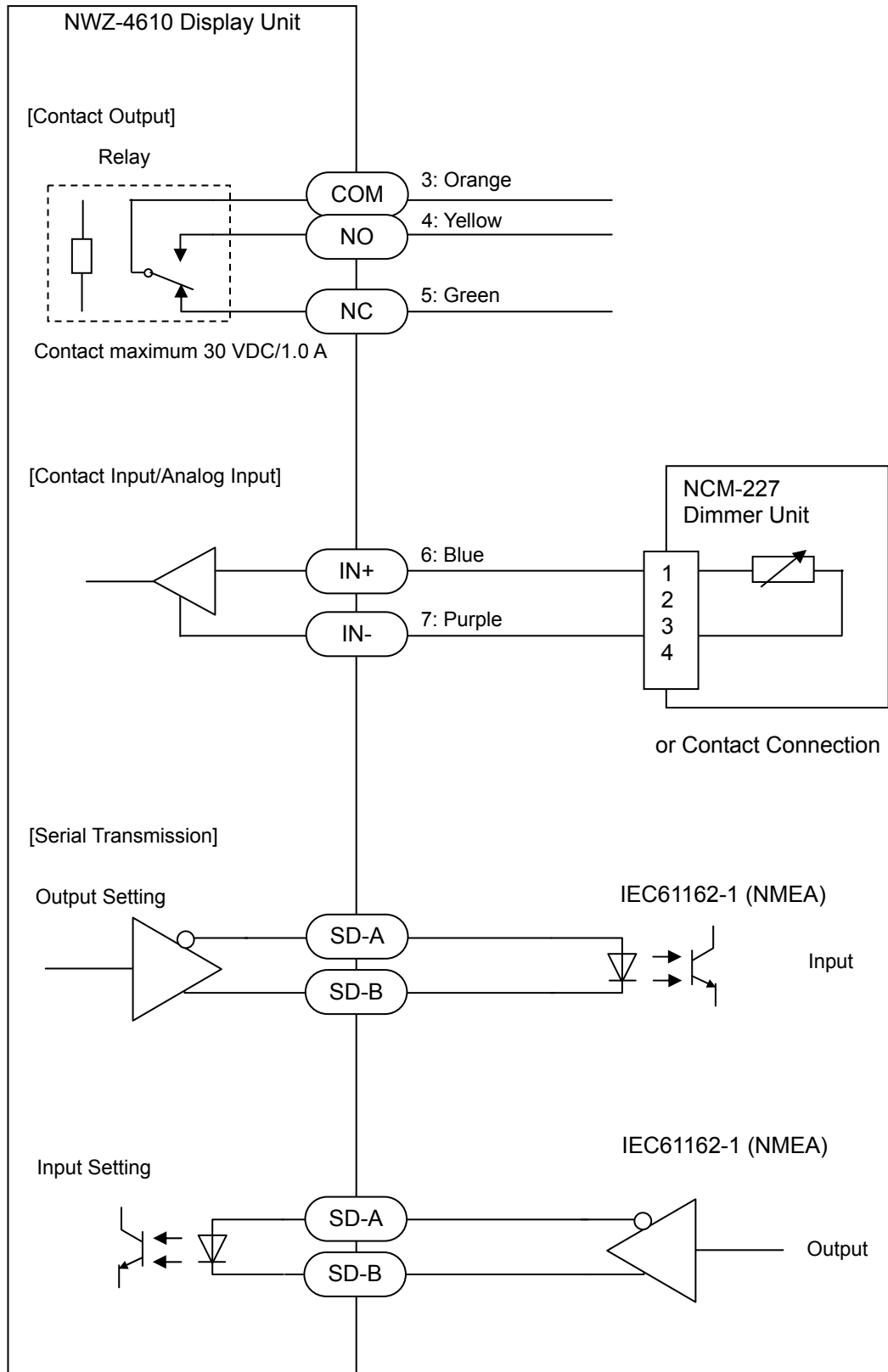

6.3.2. DATA1 connector

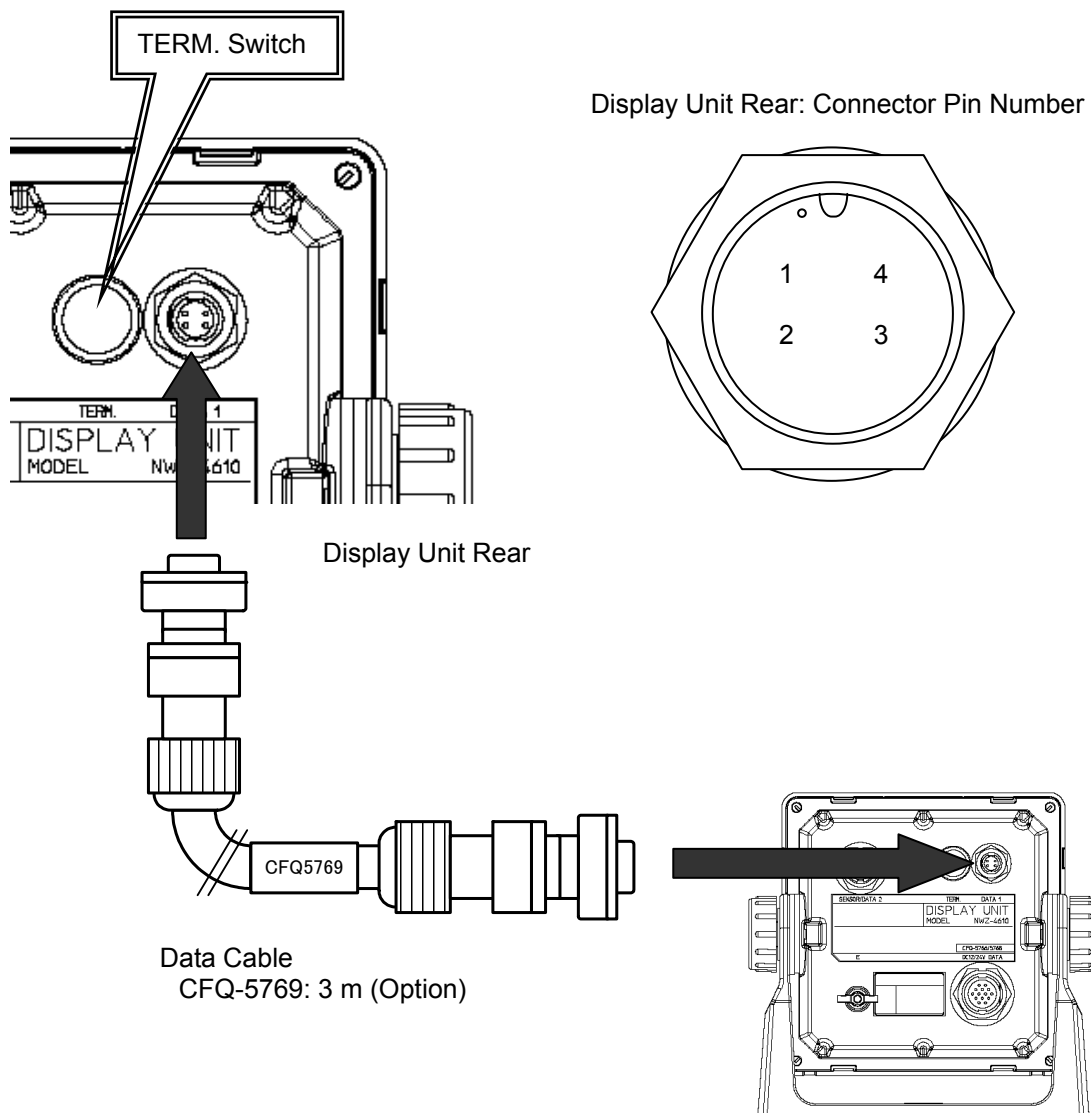

Terminal Number (CFQ-5769)		Name		Explanation
1	Brown	Serial Transmission (RS-484)	SD1-A	Connect to the display unit for serial transmission
2	Red		SD1-B	
3	Green		SD1-C	
4	Shield	Chassis Earth	E	Chassis earth

[TERM. Switch]

When this terminal is connected, move the TERM. switch (terminator) to ON.

To connect multiple units, move the TERM. switches on both ends of the display unit to ON.

When the rubber cap is removed, the switch appears.

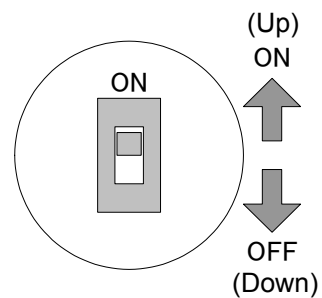

[T-SHAPED CONNECTOR]

This T-SHAPED CONNECTOR can be used to extend cables and connect multiple units (up to 10 units).

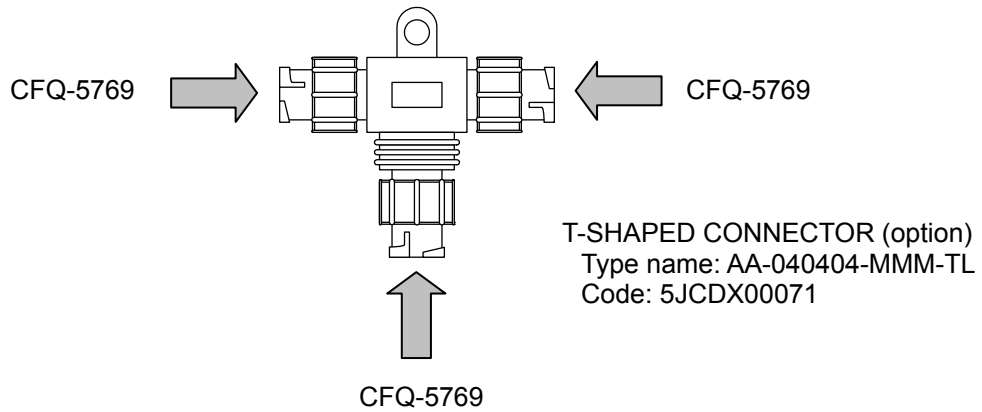

[To Extend the Cable]

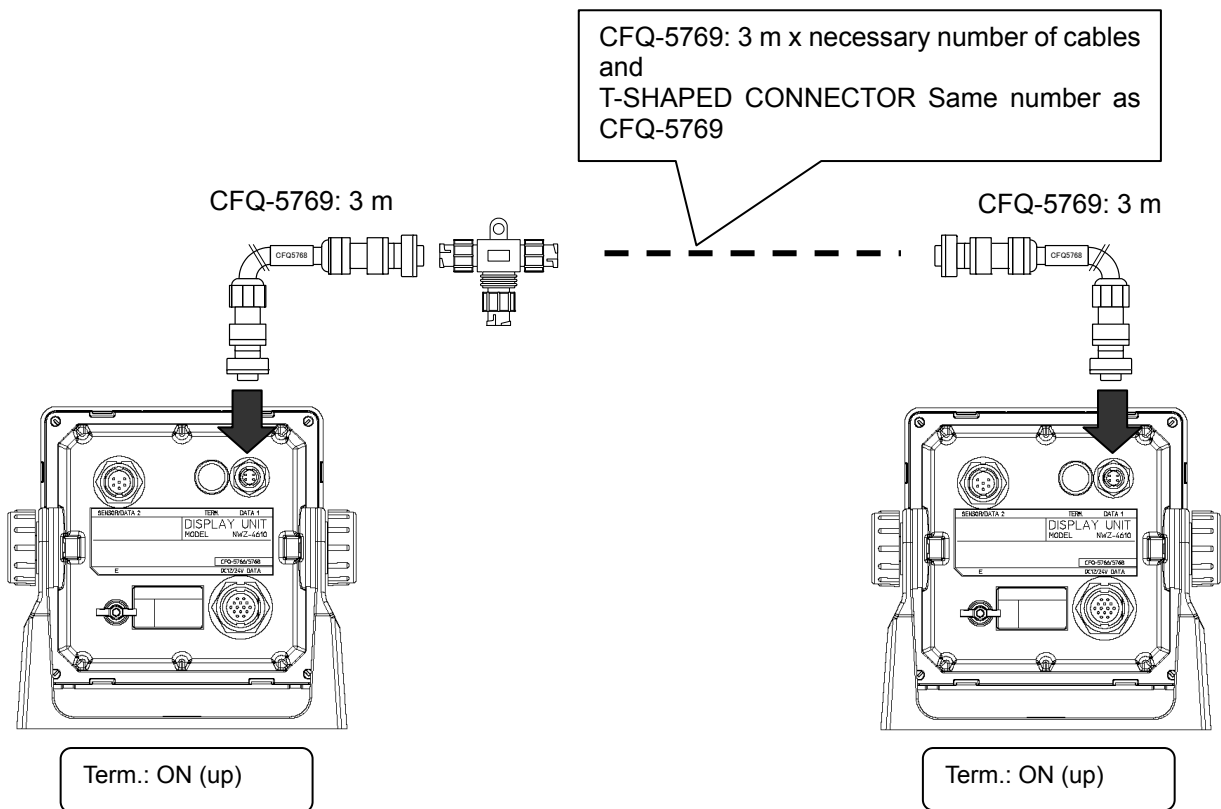

[To Connect Multiple Units]

- Up to 10 units can be connected.

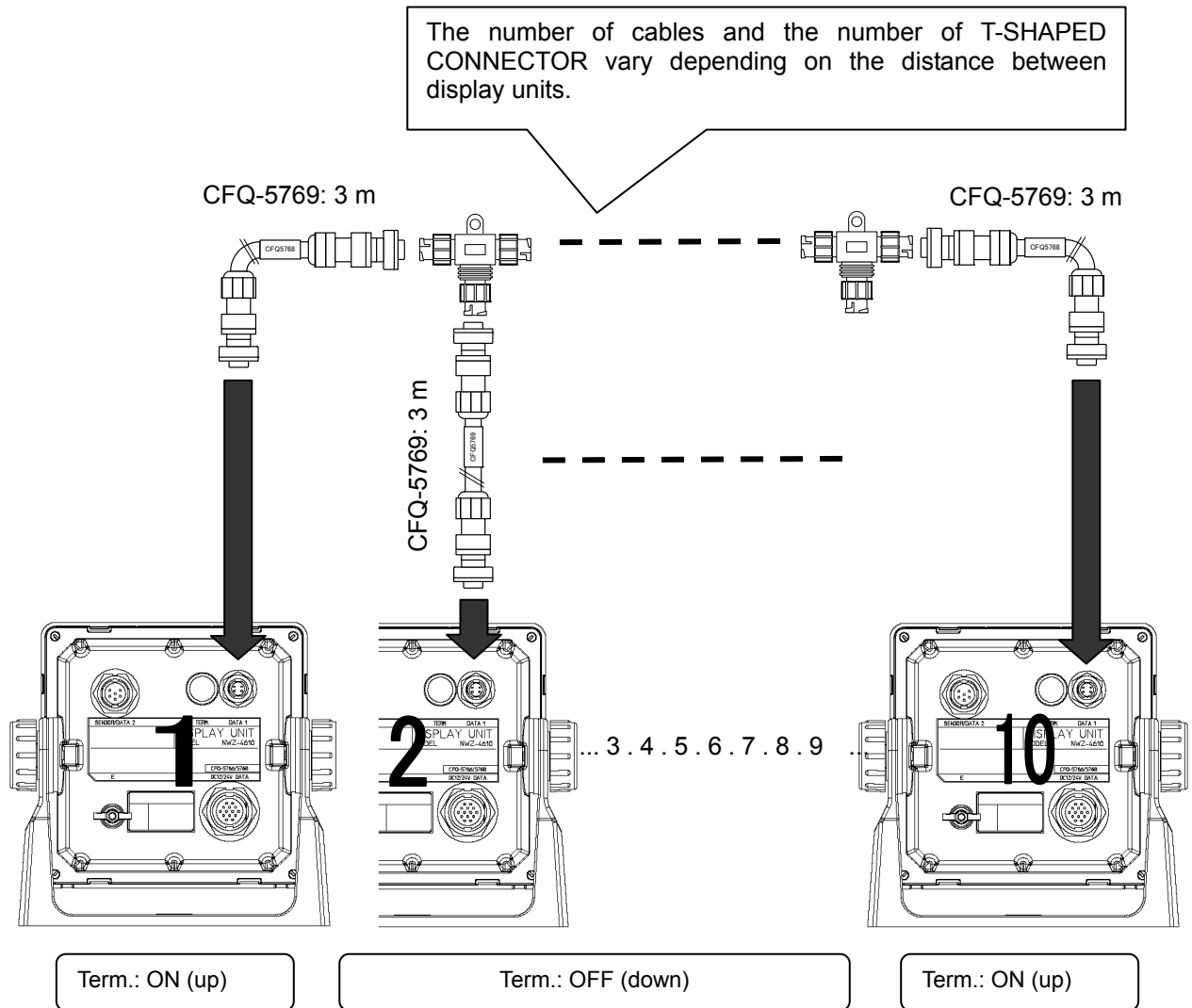

[To Group Dimmer Control]

The following shows an example of grouping 10 units (maximum number of connections) into 3 units, 3 units, 3 units, and 4 units.

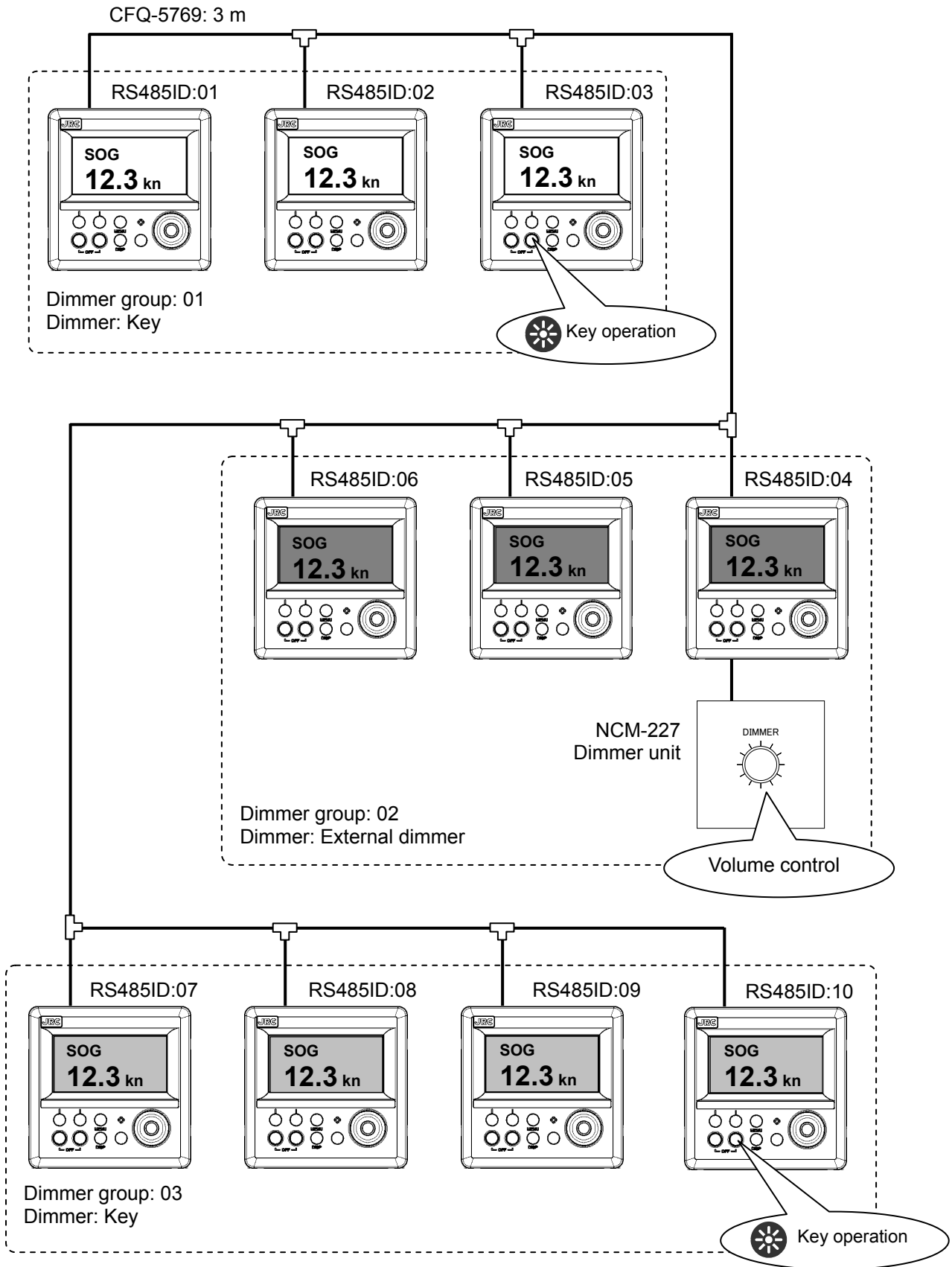

6.3.3. SENSOR/DATA2 connector

[For serial communication with external device]

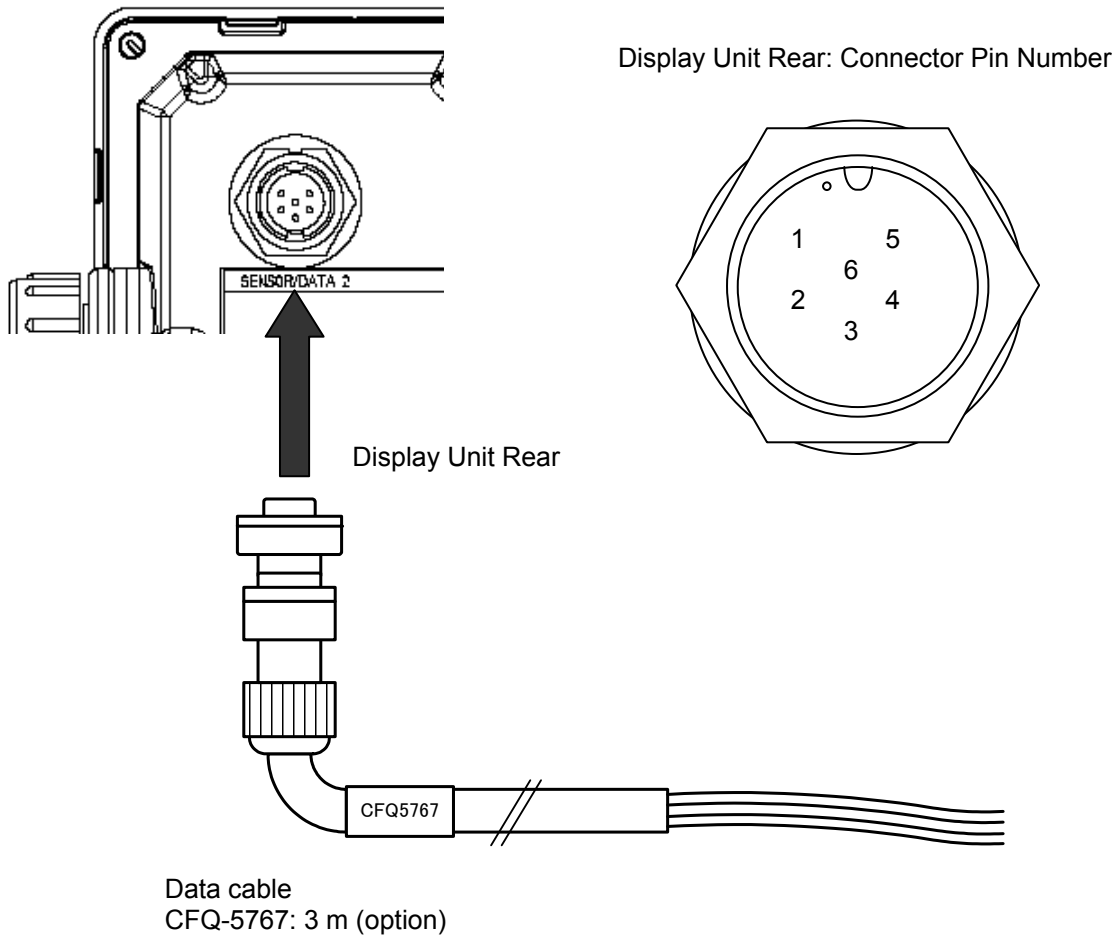

Terminal Number	Name		Explanation
1	-	Unused	
2	-		
3	White	Serial transmission DATA IN 4	Input to the specification set by "DATA IN/OUT4."
4	Green		
5	Yellow	Serial transmission DATA OUT 4	Output to the specification set by "DATA IN/OUT4."
6	Brown		

[For outputting together four data from one port]

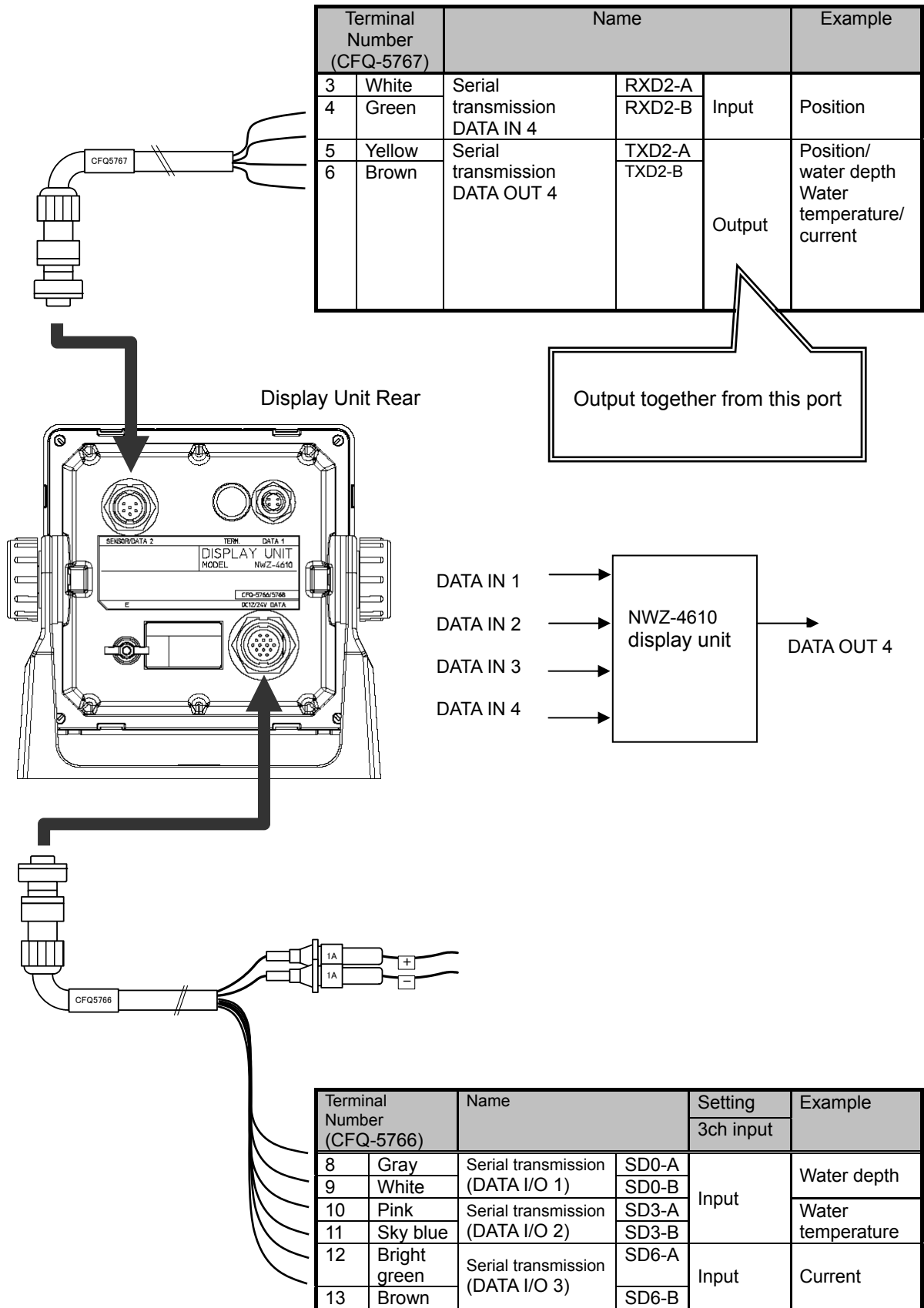

[To daisy-chain the units]

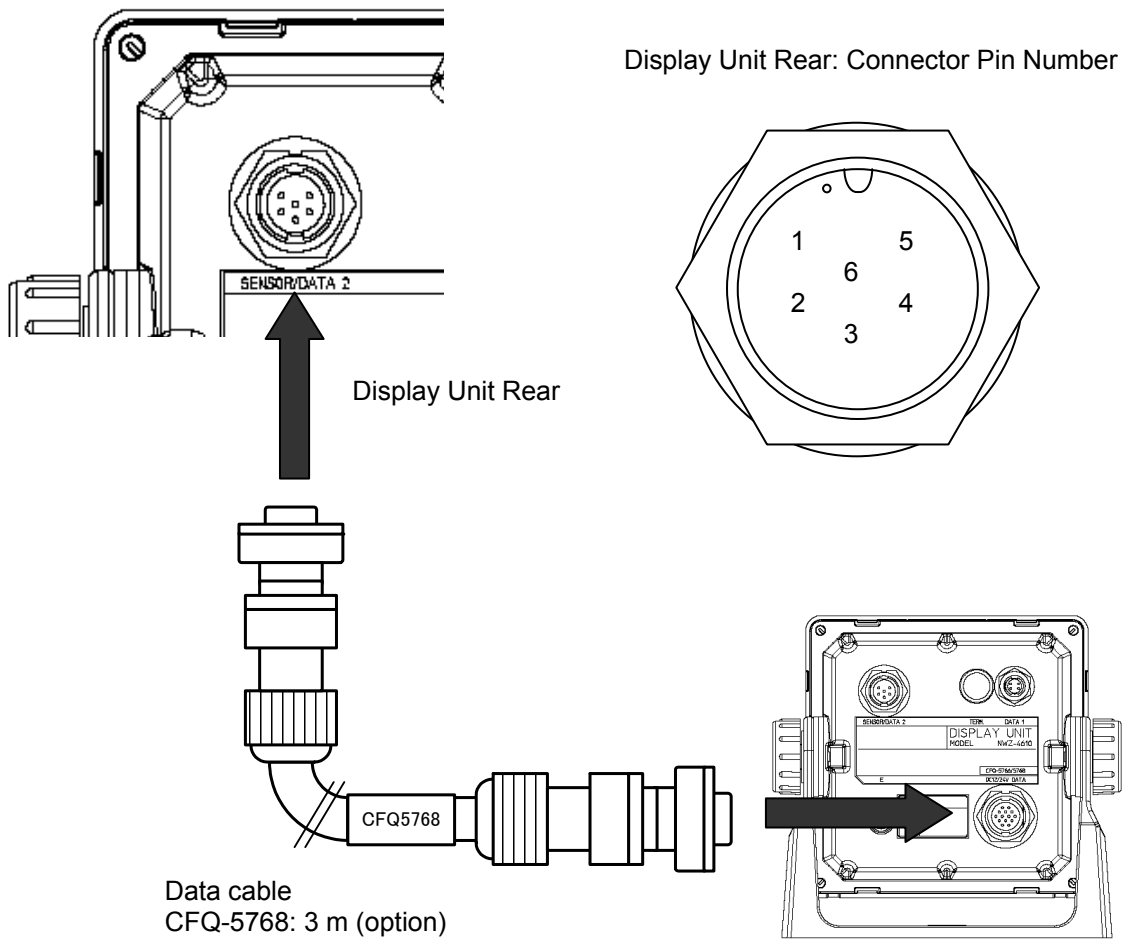

Terminal Number (CFQ-5768)		Name		Example
1	Red	Power supply output	DCOUT+	Supplies the power to the subsequent display unit.
2	Black		DCOUT-	
3	White	Serial transmission DATA IN 4	RXD2-B	Receives data from the subsequent display unit.
4	Green		RXD2-A	
5	Yellow	Serial transmission DATA OUT 4	TXD2-A	Sends data to the subsequent display unit.
6	Brown		TXD2-B	

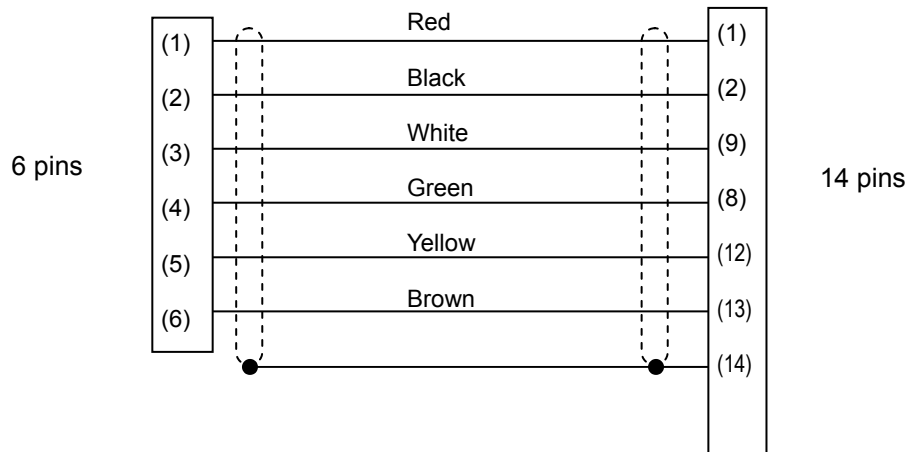

- Up to three units can be daisy-chained.
- To make this connection, set the daisy-chain setting to ON.

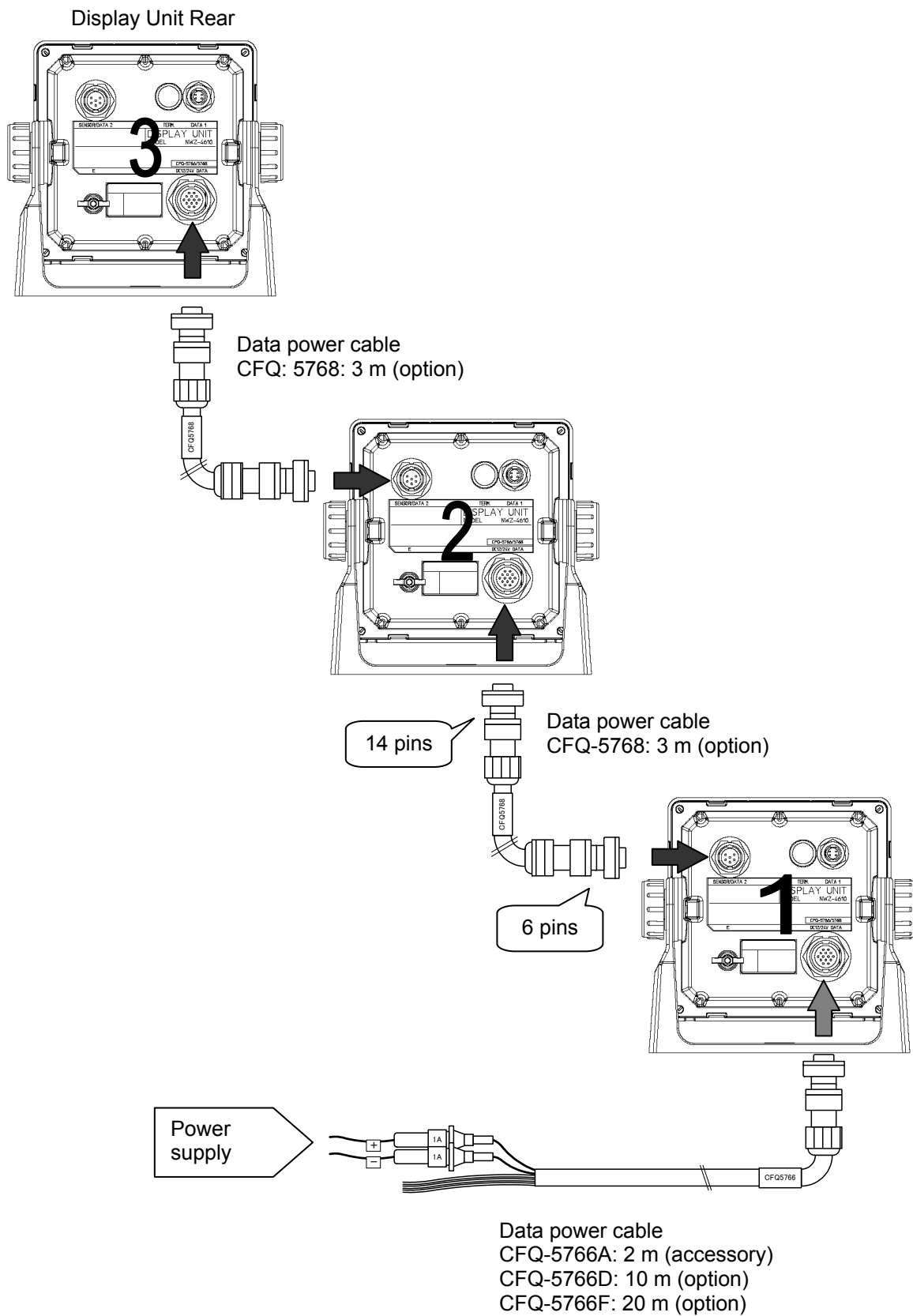

6.4. Optional Peripheral Connection

6.4.1. Dimmer unit connection

The brightness of the backlight can be changed at a location away from the display unit by connecting the dimmer unit (NCM-227).

To calibrate the external dimmer unit, refer to "7.1 Calibration of External dimmer unit "in service manual.

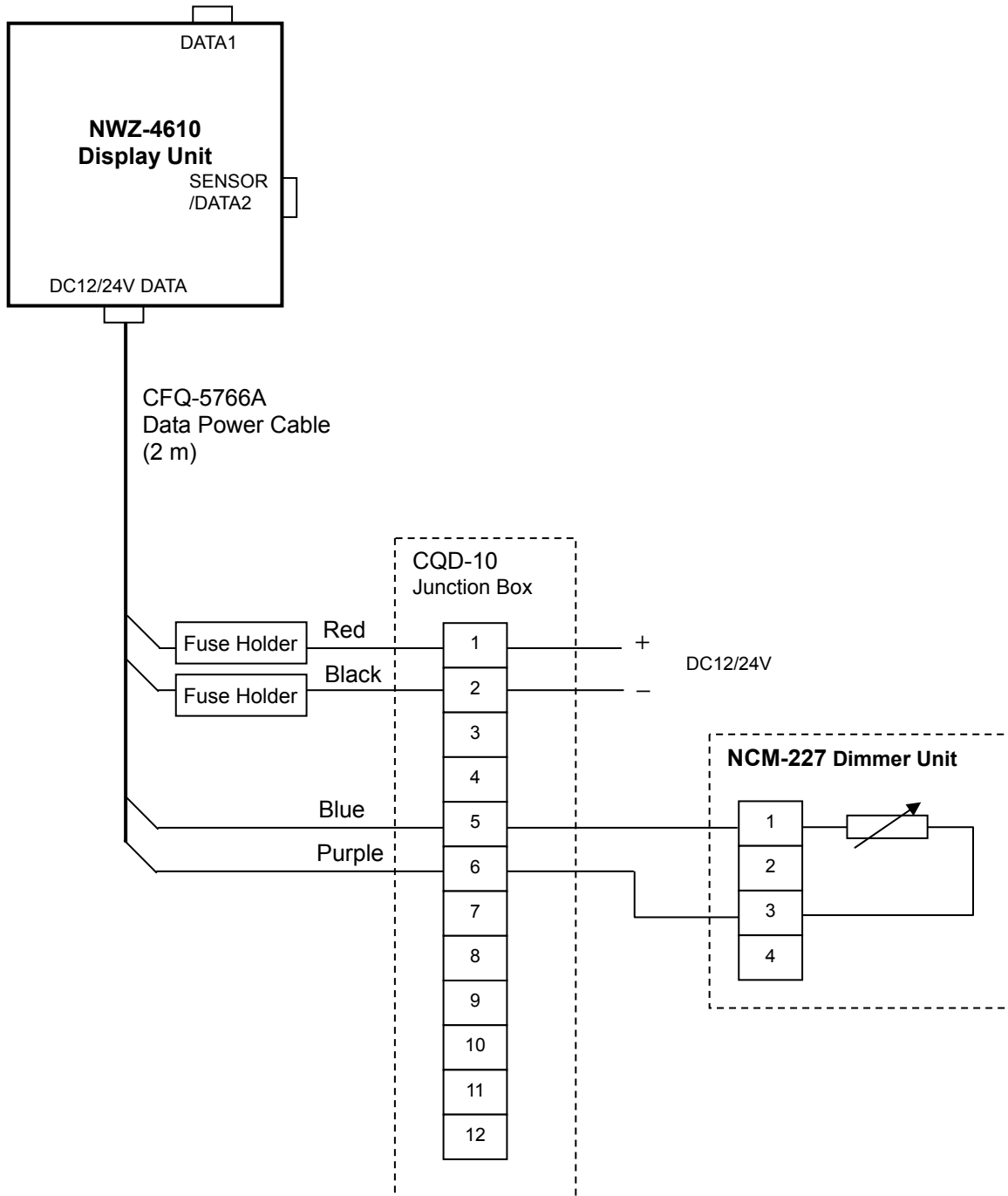

Chapter 7 After-Sales Service

7.1. When Ordering a Repair

When a failure has been detected, stop operation and contact the dealer or agent from which you purchased the device or one of our branches, marketing offices, and representative offices.

- **Repair during warranty period** Should a malfunction occur when the unit has been operated according to descriptions and instructions in the instruction manual, it will be repaired free of charge. However, breakdowns resulting from abuse, negligence, natural disaster, fire or other unforeseeable incident will be charged.
- **Repair after warranty period** Repairs that restore normal operation made after the warranty period have to be paid in full by the client.
- **Product data that should be provided when you ask for service**
 - Name of product, model, date of manufacture and serial number
 - Description of malfunction (as detailed as possible)
 - Company address or name of organization, address and telephone number

7.2. Recommendation of Overhaul

The performances of the set may deteriorate due to the aging of parts, and so on through the rate varies depending on the conditions of use. So it is recommendable to contact the dealer from which you purchased the device or one of our marketing offices for overhaul apart from daily service.

Incidentally, such overhaul will be performed with charge.

Please contact the dealer from which you purchased the device or our marketing office that is nearest to you for any question as to the after-sales service.

Chapter 8 Disposal

8.1. Disposal of the Equipment

Observe all local laws and regulations when disposing of those units.

The battery is not used for those units.

Chapter 9 Specifications

1) Basic

- Display Unit: 4.5 inch monochrome LCD 128 × 64 dots
- Backlight: White LED or orange LED (selectable)
- Dimmer Levels: 4 levels (Bright, Medium, Dark, OFF)
- Dimmer control: Key or external dimmer unit
- Contrast: 13 levels
- Key: 12 keys
- Memory backup: Flash memory
- Power Supply Voltage: 12/24VDC (10.8~31.2V)
- Power consumption: Less than 2.5W
- Data share: NMEA data, Dimmer data for RS-485 (Up to 10 units)
- Daisy chain: Power distribution (Up to 3units)
- Interface:
 - Data 1 connector: Data sharing (RS-485)
 - Data connector: DC12/24V
 - Serial input or output 3 ports (RS-422)
 - Contact input and output 1 port
 - Sensor/data 2 connector: Serial input and output or Daisy chain
- Dimension:
 - 142(W) × 142(H) × 92(D) mm (without Base unit)
 - 175(W) × 162(H) × 92(D) mm (Include Base unit)
- Mass: Approximately 0.8 kg
- Color: N4
- Installation: Table, Flush mount

2) Environment

- Operating Temperature: -15 °C to +55 °C
- Storage Temperature: -25 °C to +70 °C
- Vibration: IEC60945 ed.4 compliant
- EMC: IEC60945 ed.4 compliant
- Waterproofing: IP55

3) Interface

(1) Serial Transmission

Channel	Specification			Notes
DATA IN/OUT1	RS-422	Input or Output	NMAE, IEC	
DATA IN/OUT2	RS-422	Input or Output	NMEA, IEC	
DATA IN/OUT3	RS-422	Input or Output	NMEA, IEC	
DATA IN/OUT4	RS-422	Input or Output	NMEA, IEC	Daisy chain
RS-485	RS-485	Input	NMEA, IEC	
		Output		

(1-1) NMEA

- Specification: NMEA
- Version: Ver1.5, 2.1, 2.3, 4.0
- Bit rate: 4800, 9600, 19200, 38400bps
- Data bit: 8bit
- Parity: None
- Start bit: 1bit
- Stop bit: 1bit
- Output sentence ALR, ACK, APB, BWC, BWR, CUR, DBK, DBS, DBT, DPT, DTM, GGA, GLL, GNS, GSA, HDG, HDM, HDT, MDA, MHU, MMB, MTA, MTW, MWV, RMB, RMC, ROT, RPM, RSA, THS, VBW, VDR, VHW, VLW, VTG, VWR, VWT, XDR, XTE, ZDA, ZTG
- Output interval: 1s, 2s, 3s, 4s, 5s, 6s, 7s, 8s, 9s, OFF

Note) Som combinations of output sentence, bit rate, and output intervals may not be possible.

(1-2) IEC

- Specification: IEC61162-1 ed.4

(1-3) JRC

- Specification: JRC
- Bit rate: 1200bps
- Data bit: 8bit
- Parity: None
- Start bit: 1bit
- Stop bit: 2bit

(2) Contact signal

Channel	I/O	Notes
CONTACT	OUTPUT	200p/NM, 400p/NM
CONTACT	INPUT	ACK, Input of external dimmer

Appendix

Appendix 1 Outline and Setting Drawing

(1) NWZ-4610 MAIN DISPLAY (Desk form type)

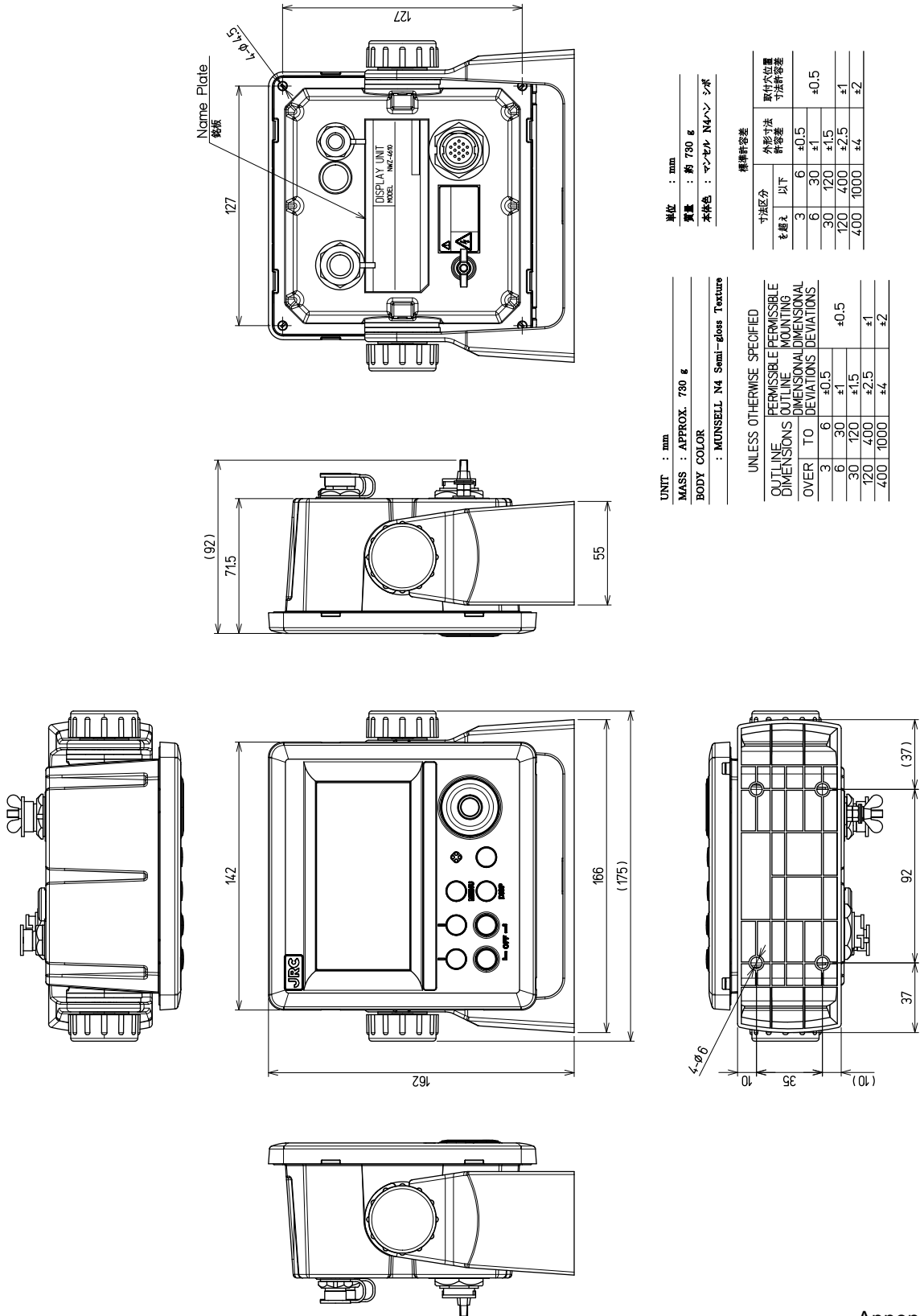

(2) NWZ-4610 MAIN DISPLAY (Console mount type)

UNIT : mm
 MASS : APPROX. 600 g
 BODY COLOR : マンセル N4半シボ

UNIT : mm
 MASS : APPROX. 600 g
 BODY COLOR : MUNSSELL N4 Semi-gloss Texture

寸法区分	標準許容差	
	寸法区分	外形寸法 許容差
寸法区分	以下	±0.5
	3	
寸法区分	6	±1
	30	
寸法区分	120	±1.5
	400	
寸法区分	120	±2.5
	400	
寸法区分	1000	±4
	400	

UNLESS OTHERWISE SPECIFIED	
PERMISSIBLE DIMENSIONS OVER	PERMISSIBLE DIMENSIONAL DEVIATIONS
3	±0.5
6	±1
30	±1.5
120	±2.5
400	±4

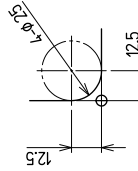

※角部C11については、
 上面の25°で加工してもよい。
 About the corner C11,
 may want to cut $\phi 25$.

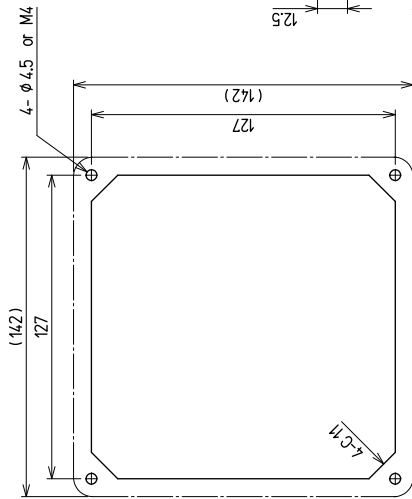

取付穴寸法図
 SETTING HOLES DRAWING

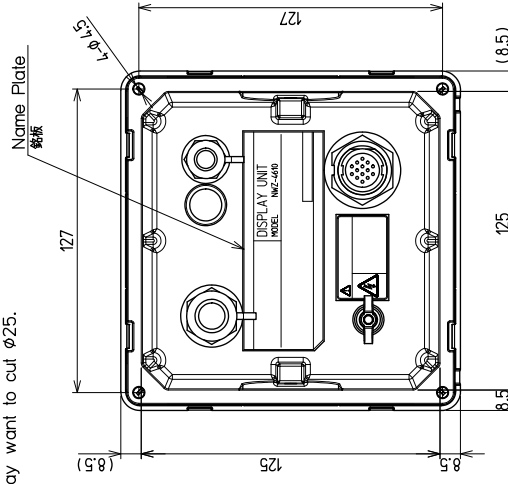
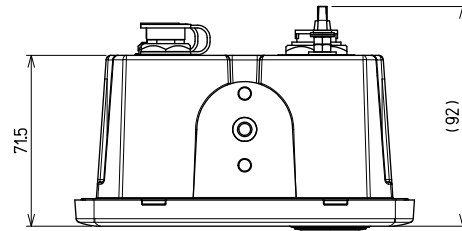
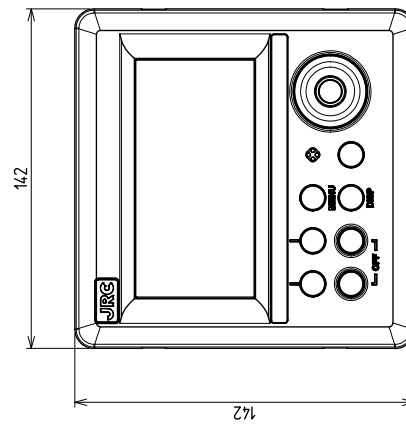
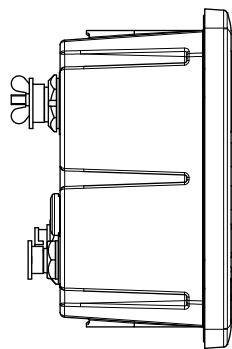

Appendix 2 Default value

Normal menu

Main menu	Sub menu	Default	remarks
DISPLAY	LCD		
	CONTRAST	7	
	DIMMER MAXIMUM	11	
	DIMMER TYPICAL	7	
	DIMMER MINMUM	3	
	CLICK SOUND	ON	
	MODE1		
	DISPLAY1	SEGMENTATION1/DOPPLER/STW	
	DISPLAY MODE	NORMAL	
	AUTO SCREEN	OFF	
	SOUND	OFF	
	TIME	1sec	
	DISPLAY2	SEGMENTATION1/OWN SHIP/SOG	
	DISPLAY MODE	NORMAL	
	AUTO SCREEN	OFF	
	SOUND	OFF	
	TIME	1sec	
	DISPLAY3	SPECIAL/WIND	
	DISPLAY MODE	NORMAL	
	AUTO SCREEN	OFF	
	SOUND	OFF	
	TIME	1sec	
	DISPLAY4	GRAPHIC/WIND	
	DISPLAY MODE	NORMAL	
	AUTO SCREEN	OFF	
	SOUND	OFF	
	TIME	1sec	
	DISPLAY5	SEGMENTATION1/DOPPLER/DEPTH	
	DISPLAY MODE	NORMAL	
	AUTO SCREEN	OFF	
	SOUND	OFF	
	TIME	1sec	
	DISPLAY6	GRAPHIC/DEPTH	
	DISPLAY MODE	NORMAL	
	AUTO SCREEN	OFF	
	SOUND	OFF	
	TIME	1sec	
	MODE2		
	DISPLAY1	SEGMENTATION1/OWN SHIP/LAT LON	
	DISPLAY MODE	NORMAL	
	AUTO SCREEN	OFF	
	SOUND	OFF	
	TIME	1sec	
	DISPLAY2	SEGMENTATION1/OWN SHIP/COG	
	DISPLAY MODE	NORMAL	
	AUTO SCREEN	OFF	
	SOUND	OFF	
	TIME	1sec	
	DISPLAY3	SEGMENTATION1/OWN SHIP/SOG	
	DISPLAY MODE	NORMAL	

Main menu	Sub menu	Default	remarks
	AUTO SCREEN	OFF	
	SOUND	OFF	
	TIME	1sec	
	DISPLAY4	GRAPHIC/SPEED1	
	DISPLAY MODE	NORMAL	
	AUTO SCREEN	OFF	
	SOUND	OFF	
	TIME	1sec	
	DISPLAY5	SEGMENTATION1/OWN SHIP/HDG	
	DISPLAY MODE	NORMAL	
	AUTO SCREEN	OFF	
	SOUND	OFF	
	TIME	1sec	
	DISPLAY6	SEGMENTATION1/OWN SHIP/ROT	
	DISPLAY MODE	NORMAL	
	AUTO SCREEN	OFF	
	SOUND	OFF	
	TIME	1sec	
	MODE3		
	DISPLAY1	SEGMENTATION1/DOPPLER/DEPTH	
	DISPLAY MODE	NORMAL	
	AUTO SCREEN	OFF	
	SOUND	OFF	
	TIME	1sec	
	DISPLAY2	SEGMENTATION1/WEATHER/WATER TEMP	
	DISPLAY MODE	NORMAL	
	AUTO SCREEN	OFF	
	SOUND	OFF	
	TIME	1sec	
	DISPLAY3	SPECIAL/WATER TEMP	
	DISPLAY MODE	NORMAL	
	AUTO SCREEN	OFF	
	SOUND	OFF	
	TIME	1sec	
	DISPLAY4	SEGMENTATION1/WEATHER/AIR TEMP	
	DISPLAY MODE	NORMAL	
	AUTO SCREEN	OFF	
	SOUND	OFF	
	TIME	1sec	
	DISPLAY5	SEGMENTATION1/WEATHER/HUMIDITY	
	DISPLAY MODE	NORMAL	
	AUTO SCREEN	OFF	
	SOUND	OFF	
	TIME	1sec	
	DISPLAY6	SEGMENTATION1/WEATHER/PRESSURE	
	DISPLAY MODE	NORMAL	
	AUTO SCREEN	OFF	
	SOUND	OFF	
	TIME	1sec	
	BACK LIGHT	WHITE	
	GRAPH SCALE		
	DEPTH		
	TIME	10min	
	MAX	300m	











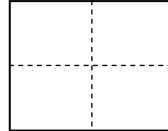

Main menu	Sub menu	Default	remarks
	MIN	0m	
	WATER TEMP		
	TIME	10min	
	MAX	+30°C	
	MIN	0°C	
	USER DISPLAY	OFF	
SYSTEM	UNIT		
	DIST/SPD	NM, kn	
	TEMP	°C/	
	DEPTH	m	
	WIND	kn	
	TIME DIFF	+00:00	
	DATE DISP		
	TIME DISP	DD MMM,'YY HH:MM /	
	MAG CORR		
	DISPLAY	OFF	
	OUTPUT	OFF	
	LORAN C		
	LORAN C	ON	
	GRI	4990	
	TD1		
	TD2	0	
	TD1 CORR	+0.0	
	TD2 CORR	+0.0	
	DEPTH		
	TRANS	FWD	
	OFFSET	+0.0	
LANG.	LANG.	English	
ALARM	SYSTEM	OFF	
	SPEED	OFF	
	TRIP	OFF	
	ARRIVAL	OFF	
	WATER TEMP	OFF	
	DEPTH	OFF	
	WIND	OFF	
	AIR TEMP	OFF	
	PRESSURE	OFF	
	HUMIDITY	OFF	
BEACON	DISPLAY	ON	

Maintenance menu

Main menu	Sub menu	Default	remarks
DAISY CHAIN		OFF	
INTERFACE	DATA I/O		
	DATA IN/OUT1		
	NMEA		
	DATA IN/OUT	RECEIVE	
	VERSION	-	
	SENTENCE	-	
	BIT RATE	4800	
	DATA IN/OUT2		
	NMEA		
	DATA IN/OUT	RECEIVE	
	VERSION	-	
	SENTENCE	-	
	BIT RATE	4800	
	DATA IN/OUT3		
	NMEA		
	DATA IN/OUT	RECEIVE	
	VERSION	-	
	SENTENCE	-	
	BIT RATE	4800	
	DATA IN/OUT4		
	NMEA		
	VERSION	1.5	
	SENTENCE	all OFF	
	BIT RATE	4800	
	RS-485		
	IEC		
	SENTENCE	all OFF	
	BIT RATE	115200	
	CONTACT INPUT	ACK	
	CONTACT OUTPUT	OFF	
DISPLAY TYPE		MID	Factory setting: OFF
RS-485ID		1	
DIMMER GROUP		1	
DIMMER		KEY	
CURRENT		LAYER	

Appendix 3 Setting value memo

Normal menu

Main menu	Sub menu	Setting value												
DISPLAY	LCD	-												
	CONTRAST	1	2	3	4	5	6	7	8	9	10	11	12	13
	DIMMER MAXIMUM	4	5	6	7	8	9	10	11	12	13			
	DIMMER TYPICAL	3	4	5	6	7	8	9	10	11	12			
	DIMMER MINMUM	2	3	4	5	6	7	8	9	10	11			
	CLICK SOUND	ON/OFF												
	MODE1	-												
	DISPLAY1	DISPLAY2	DISPLAY3	DISPLAY4	DISPLAY5	DISPLAY6								
	SEGMENT1 SEGMENT2 SEGMENT3 SEGMENT4 GRAPHIC SPECIAL OFF	SEGMENT1 SEGMENT2 SEGMENT3 SEGMENT4 GRAPHIC SPECIAL OFF	SEGMENT1 SEGMENT2 SEGMENT3 SEGMENT4 GRAPHIC SPECIAL OFF	SEGMENT1 SEGMENT2 SEGMENT3 SEGMENT4 GRAPHIC SPECIAL OFF	SEGMENT1 SEGMENT2 SEGMENT3 SEGMENT4 GRAPHIC SPECIAL OFF	SEGMENT1 SEGMENT2 SEGMENT3 SEGMENT4 GRAPHIC SPECIAL OFF								
														
	DISPLAY MODE NORMAL/ SPECIAL1/ SPECIAL2/ AUTO RANGE AUTO SCREEN ON/OFF SOUND SOUND1/ SOUND2/ OFF TIME sec	DISPLAY MODE NORMAL/ SPECIAL1/ SPECIAL2/ AUTO RANGE AUTO SCREEN ON/OFF SOUND SOUND1/ SOUND2/ OFF TIME sec	DISPLAY MODE NORMAL/ SPECIAL1/ SPECIAL2/ AUTO RANGE AUTO SCREEN ON/OFF SOUND SOUND1/ SOUND2/ OFF TIME sec	DISPLAY MODE NORMAL/ SPECIAL1/ SPECIAL2/ AUTO RANGE AUTO SCREEN ON/OFF SOUND SOUND1/ SOUND2/ OFF TIME 1-10sec	DISPLAY MODE NORMAL/ SPECIAL1/ SPECIAL2/ AUTO RANGE AUTO SCREEN ON/OFF SOUND SOUND1/ SOUND2/ OFF TIME sec	DISPLAY MODE NORMAL/ SPECIAL1/ SPECIAL2/ AUTO RANGE AUTO SCREEN ON/OFF SOUND SOUND1/ SOUND2/ OFF TIME sec								
	MODE2		-											
	DISPLAY1	DISPLAY2	DISPLAY3	DISPLAY4	DISPLAY5	DISPLAY6								
	SEGMENT1 SEGMENT2 SEGMENT3 SEGMENT4 GRAPHIC SPECIAL OFF	SEGMENT1 SEGMENT2 SEGMENT3 SEGMENT4 GRAPHIC SPECIAL OFF	SEGMENT1 SEGMENT2 SEGMENT3 SEGMENT4 GRAPHIC SPECIAL OFF	SEGMENT1 SEGMENT2 SEGMENT3 SEGMENT4 GRAPHIC SPECIAL OFF	SEGMENT1 SEGMENT2 SEGMENT3 SEGMENT4 GRAPHIC SPECIAL OFF	SEGMENT1 SEGMENT2 SEGMENT3 SEGMENT4 GRAPHIC SPECIAL OFF								
														
	DISPLAY MODE NORMAL/ SPECIAL1/ SPECIAL2/ AUTO RANGE AUTO SCREEN ON/OFF SOUND SOUND1/ SOUND2/ OFF TIME sec	DISPLAY MODE NORMAL/ SPECIAL1/ SPECIAL2/ AUTO RANGE AUTO SCREEN ON/OFF SOUND SOUND1/ SOUND2/ OFF TIME sec	DISPLAY MODE NORMAL/ SPECIAL1/ SPECIAL2/ AUTO RANGE AUTO SCREEN ON/OFF SOUND SOUND1/ SOUND2/ OFF TIME sec	DISPLAY MODE NORMAL/ SPECIAL1/ SPECIAL2/ AUTO RANGE AUTO SCREEN ON/OFF SOUND SOUND1/ SOUND2/ OFF TIME 1-10sec	DISPLAY MODE NORMAL/ SPECIAL1/ SPECIAL2/ AUTO RANGE AUTO SCREEN ON/OFF SOUND SOUND1/ SOUND2/ OFF TIME sec	DISPLAY MODE NORMAL/ SPECIAL1/ SPECIAL2/ AUTO RANGE AUTO SCREEN ON/OFF SOUND SOUND1/ SOUND2/ OFF TIME sec								

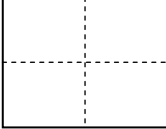
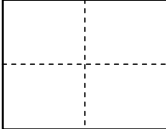
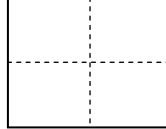
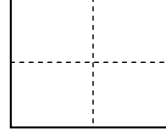
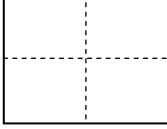
Main menu	Sub menu		Setting value			
	MODE3		-			
	DISPLAY1	DISPLAY2	DISPLAY3	DISPLAY4	DISPLAY5	DISPLAY6
	SEGMENT1 SEGMENT2 SEGMENT3 SEGMENT4 GRAPHIC SPECIAL OFF	SEGMENT1 SEGMENT2 SEGMENT3 SEGMENT4 GRAPHIC SPECIAL OFF	SEGMENT1 SEGMENT2 SEGMENT3 SEGMENT4 GRAPHIC SPECIAL OFF	SEGMENT1 SEGMENT2 SEGMENT3 SEGMENT4 GRAPHIC SPECIAL OFF	SEGMENT1 SEGMENT2 SEGMENT3 SEGMENT4 GRAPHIC SPECIAL OFF	SEGMENT1 SEGMENT2 SEGMENT3 SEGMENT4 GRAPHIC SPECIAL OFF
						
	DISPLAY MODE NORMAL/ SPECIAL1/ SPECIAL2/ AUTO RANGE AUTO SCREEN ON/OFF SOUND SOUND1/ SOUND2/ OFF TIME	DISPLAY MODE NORMAL/ SPECIAL1/ SPECIAL2/ AUTO RANGE AUTO SCREEN ON/OFF SOUND SOUND1/ SOUND2/ OFF TIME	DISPLAY MODE NORMAL/ SPECIAL1/ SPECIAL2/ AUTO RANGE AUTO SCREEN ON/OFF SOUND SOUND1/ SOUND2/ OFF TIME	DISPLAY MODE NORMAL/ SPECIAL1/ SPECIAL2/ AUTO RANGE AUTO SCREEN ON/OFF SOUND SOUND1/ SOUND2/ OFF TIME	DISPLAY MODE NORMAL/ SPECIAL1/ SPECIAL2/ AUTO RANGE AUTO SCREEN ON/OFF SOUND SOUND1/ SOUND2/ OFF TIME	DISPLAY MODE NORMAL/ SPECIAL1/ SPECIAL2/ AUTO RANGE AUTO SCREEN ON/OFF SOUND SOUND1/ SOUND2/ OFF TIME
	sec	sec	sec	1-10sec	sec	sec
	BACK LIGHT		WHITE/ORANGE			
	GRAPH SCALE		-			
	DEPTH		-			
	TIME		5min/10min/20min/30min			
	MAX					
	MIN					
	WATER TEMP		-			
	TIME		5min/10min/20min/30min			
	MAX		-			
	MIN		-			
	USER DISPLAY		DISPLAY1/DISPLAY2/DISPLAY3/DISPLAY4/DISPLAY5/ DISPLAY6/OFF			
SYSTEM	UNIT		-			
	DIST/SPD		NM, kn/km, km/h/mi, mi/h/m, m/s			
	TEMP		°C/°F			
	DEPTH		m/ft/fm			
	WIND		kn/km/h/mi/h/m/s			
	TIME DIFF		:			
	DATE DISP		-			
	TIME DISP		DD MMM, 'YY HH:MM / MMM DD, 'YY HH:MM / YY-MMM-DD HH:MM			
	MAG CORR					
	DISPLAY		OFF/AUTO/MANUAL			
	OUTPUT		OFF/AUTO/MANUAL			
	LORAN C		-			
	LORAN C		ON/OFF			
	GRI		-			
	TD1					
	TD2					
	TD1 CORR					
	TD2 CORR					
	DEPTH		-			
	TRANS		FWD/MID/AFT			
	OFFSET		-99.9 - +99.9			

Main menu	Sub menu	Setting value
LANG.	LANG.	UK/Japan/France/Germany/Italy/Norway/Spain/Vietnam/Indonesia
ALARM	SYSTEM	ON/OFF
	SOUND	ON/OFF
	LCD COLOR	ON/OFF
	SPEED	OVER/UNDER/IN RANG/OUT RANG/OFF
	OVER UNDER MAXIMUM MINIMUM	
	SOUND	ON/OFF
	LCD COLOR	ON/OFF
	TRIP	OVER/OFF
	OVER	
	SOUND	ON/OFF
	LCD COLOR	ON/OFF
	WATER TEMP	OVER/UNDER/IN RANG/OUT RANG/OFF
	OVER UNDER MAXIMUM MINIMUM	
	SOUND	ON/OFF
	LCD COLOR	ON/OFF
	DEPTH	OVER/UNDER/IN RANG/OUT RANG/OFF
	OVER UNDER MAXIMUM MINIMUM	
	SOUND	ON/OFF
	LCD COLOR	ON/OFF
	WIND	OVER/OFF
	OVER	
	SOUND	ON/OFF
	LCD COLOR	ON/OFF
	AIR TEMP	OVER/UNDER/IN RANG/OUT RANG/OFF
	OVER UNDER MAXIMUM MINIMUM	
	SOUND	ON/OFF
	LCD COLOR	ON/OFF
	PRESSURE	OVER/UNDER/IN RANG/OUT RANG/OFF
	OVER UNDER MAXIMUM MINIMUM	
	SOUND	ON/OFF
	LCD COLOR	ON/OFF
	HUMIDITY	OVER/UNDER/IN RANG/OUT RANG/OFF
	OVER UNDER MAXIMUM MINIMUM	
	SOUND	ON/OFF
	LCD COLOR	ON/OFF
BEACON	DISPLAY	ON/OFF

Maintenance menu

Main menu	Sub menu	Setting vlaue
DAISY CHAIN		ON/OFF
INTERFACE	DATA I/O	
	DATA IN/OUT1	
	NMEA	
	DATA IN/OUT	SEND/RECEIVE
	VERSION	1.5/2.1/2.3/4.0
	SENTENCE	DATA IN/OUT1 SENTENCE
	BIT RATE	4800/9600/19200/38400
	IEC	-
	DATA IN/OUT	SEND/RECEIVE
	SENTENCE	DATA IN/OUT1 SENTENCE
	BIT RATE	4800/9600/19200/38400
		DATA IN/OUT1 SENTENCE CUR: BDK: DBS: DBT: DPT: GGA: GLL: GNS: HDG: HDM: HDT: MDA: MHU: MMB: MTA: MTW: MWV: RMC: ROT: RPM: RSA: THS: VBW: VDR: VHW: VLW: VTG: VWR: VWT: XDR: ZDA: PJRCS,DPT: PJRCU,SD:
	JRC	
	INTERVAL	OFF/4s
	DATA IN/OUT2	-
	NMEA	-
	DATA IN/OUT	SEND/RECEIVE
	VERSION	1.5/2.1/2.3/4.0
	SENTENCE	DATA IN/OUT2 SENTENCE
	BIT RATE	4800/9600/19200/38400
	IEC	-
	DATA IN/OUT	SEND/RECEIVE
	SENTENCE	DATA IN/OUT2 SENTENCE
	BIT RATE	4800/9600/19200/38400
		DATA IN/OUT2 SENTENCE CUR: BDK: DBS: DBT: DPT: GGA: GLL: GNS: HDG: HDM: HDT: MDA: MHU: MMB: MTA: MTW: MWV: RMC: ROT: RPM: RSA: THS: VBW: VDR: VHW: VLW: VTG: VWR: VWT: XDR: ZDA: PJRCS,DPT: PJRCU,SD:
	JRC	
	INTERVAL	OFF/4s
	DATA IN/OUT3	-
	NMEA	-
	DATA IN/OUT	SEND/RECEIVE
	VERSION	1.5/2.1/2.3/4.0
	SENTENCE	DATA IN/OUT3 SENTENCE
	BIT RATE	4800/9600/19200/38400
	IEC	-
	DATA IN/OUT	SEND/RECEIVE
	SENTENCE	DATA IN/OUT3 SENTENCE
	BIT RATE	4800/9600/19200/38400
		DATA IN/OUT3 SENTENCE CUR: BDK: DBS: DBT: DPT: GGA: GLL: GNS: HDG: HDM: HDT: MDA: MHU: MMB: MTA: MTW: MWV: RMC: ROT: RPM: RSA: THS: VBW: VDR: VHW: VLW: VTG: VWR: VWT: XDR: ZDA: PJRCS,DPT: PJRCU,SD:

Main menu	Sub menu	Setting vlaue
	JRC	
	INTERVAL	OFF/4s
	DATA IN/OUT4	-
	NMEA	-
	VERSION	1.5/2.1/2.3/4.0
	SENTENCE	DATA IN/OUT4 SENTENCE
	BIT RATE	4800/9600/19200/38400
	IEC	-
	SENTENCE	DATA IN/OUT4 SENTENCE
	BIT RATE	4800/9600/19200/38400
		DATA IN/OUT4 SENTENCE CUR: BDK: DBS: DBT: DPT: GGA: GLL: GNS: HDG: HDM: HDT: MDA: MHU: MMB: MTA: MTW: MWV: RMC: ROT: RPM: RSA: THS: VBW: VDR: VHW: VLW: VTG: VWR: VWT: XDR: ZDA: PJRCS,DPT: PJRCU,SD:
	JRC	
	INTERVAL	OFF/4s
	RS-485	-
	NMEA	-
	VERSION	1.5/2.1/2.3/4.0
	SENTENCE	RS-485 SENTENCE
	BIT RATE	38400/57600/76800/115200
	IEC	-
	SENTENCE	RS-485 SENTENCE
	BIT RATE	38400/57600/76800/115200
		RS-485 SENTENCE CUR: BDK: DBS: DBT: DPT: GGA: GLL: GNS: HDG: HDM: HDT: MDA: MHU: MMB: MTA: MTW: MWV: RMC: ROT: RPM: RSA: THS: VBW: VDR: VHW: VLW: VTG: VWR: VWT: XDR: ZDA: PJRCS,DPT: PJRCU,SD:
	CONTACT INPUT	DIMMER/ACK
	CONTACT OUTPUT	200PULSE/NM / 400PULSE/NM / OFF
	DIAGNOSIS	-
MAINTENANCE	INPUT DATA	-
	DIAGNOSIS	-
	ERROR LOG	-
	SOFT VERSION	-
	DISPLAY VER	-
	APP VER	
	SERIAL NUMBER	
	BARCODE	
MASTER RESET	GRAPH RESET	-
	DISPLAY RESET	-
DEMO MODE		-
SOFT UPDATE	DISPLAY	
DESPLAY TYPE		MID/LOG/GPS/OFF
RS-485ID		1 2 3 4 5 6 7 8 9 10
DIMMER GROUP		1 2 3 4 5 6 7 8 9 10
DIMMER		KEY/EXT DIMMER
CURRENT		LAYER/DATA No

有毒有害物质或元素的名称及含量

(Names & Content of toxic and hazardous substances or elements)

形式名(Type): NWZ-4610

名称(Name): Multi Information Display (MID)

部件名称 (Part name)	有毒有害物质或元素 (Toxic and Hazardous Substances and Elements)					
	铅 (Pb)	汞 (Hg)	镉 (Cd)	六价铬 (Cr ⁶⁺)	多溴联苯 (PBB)	多溴二苯醚 (PBDE)
显示装置(Display Unit)	×	×	×	×	×	×
外部设备(Peripherals) 选择(Options) 电线类(Cables) 手册(Documentts)	×	○	×	×	×	×
<p>○:表示该有毒有害物质在该部件所有均质材料中的含量均在SJ/T11306-2006 标准规定的限量要求以下。 (Indicates that this toxic, or hazardous substance contained in all of the homogeneous materials for this part is below the requirement in SJ/T11363-2006.)</p> <p>×:表示该有毒有害物质至少在该部件的某一均质材料中的含量超出SJ/T11363-2006 标准规定的限量要求。 (Indicates that this toxic or hazardous substance contained in at least one of the homogeneous materials used for this part is above the limit requirement in SJ/T 11363-2006.)</p>						

アスベストは使用していません
Not use the asbestos

CODE No.7ZPNA4284

For further information, contact:



Japan Radio Co., Ltd.

Since 1915

URL <http://www.jrc.co.jp>

Marine Service Department

Telephone : +81-3-3492-1305

Facsimile : +81-3-3779-1420

e-mail : tmsc@jrc.co.jp

AMSTERDAM Branch

Telephone : +31-20-658-0750

Facsimile : +31-20-658-0755

e-mail : service@jrceurope.com

SEATTLE Branch

Telephone : +1-206-654-5644

Facsimile : +1-206-654-7030

e-mail : marineservice@jrcamerica.com

01ETM

ISO 9001, ISO 14001 Certified

©DEC. 2014 Edition 3 JRC

Printed in Japan