

# JFC-180BB

Preparation	1
Basic operation	2
To make the best of [CM] keys	3
Useful operation	4
Maintenance and Inspection	5
Specifications	6
Outside Drawing	7
Index	8

## Echo Sounder

## Instruction Manual

<Basic>



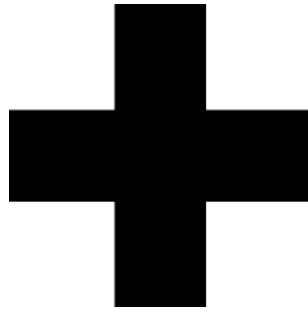

## Cautions for High Voltage

High voltages, ranging from several hundreds to tens of thousands of volts, are used in electronic apparatus, such as radio and radar instruments. These voltages are totally harmless in most operations. However, touching a component inside the unit is very dangerous. (Any person other than authorized service engineers should not maintain, inspect, or adjust the unit.)

High voltages on the order of tens of thousand volts are most likely to cause instant deaths from electrical shocks. At times, even voltages on the order of several hundred volts could lead to electrocution. To defend against electrical shock hazards, don't put your hand into the inside of apparatus. When you put in a hand unavoidably in case of urgent, it is strongly suggested to turn off the power switch and allow the capacitors, etc. to discharge with a wire having its one end positively grounded to remove residual charges. Before you put your hand into the inside of apparatus, make sure that internal parts are no longer charged. Extra protection is ensured by wearing dry cotton gloves at this time. Another important precaution to observe is to keep one hand in your pocket at a time, instead of using both hands at the same time.

It is also important to select a secure footing to work on, as the secondary effects of electrical shock hazards can be more serious. In the event of electrical shocks, disinfect the burnt site completely and obtain medical care immediately.

## **Precautions for Rescue of Victim of Electric Shock**

When a victim of electric shock is found, turn off the power source and ground the circuit immediately. If this is impossible, move the victim away from the unit as quick as possible without touching him or her with bare hands. He or she can safely be moved if an insulating material such as dry wood plate or cloth is used.

Breathing may stop if current flows through the respiration center of brain due to electric shock. If the electric shock is not large, breathing can be restored by artificial respiration. A victim of electric shock looks pale and his or her pulse may become very weak or stop, resulting in unconsciousness and rigidity at worst. It is necessary to perform first aid immediately.

# Method of First-Aid Treatment

## ☆Precautions for First-Aid Treatments

Whenever a person is struck by an electrical shock, give the patient artificial respiration immediately on the spot, unless it is absolutely necessary to move the patient for safety's sake. Once started, artificial respiration should be continued rhythmically.

- (1) Refrain from touching the patient carelessly as a result of the accident; the first-aider could suffer from electrical shocks by himself or herself.
- (2) Turn off the power calmly and certainly, and move the patient apart from the cable gently.
- (3) Call or send for a physician or ambulance immediately, or ask someone to call doctor.
- (4) Lay the patient on the back, loosening the necktie, clothes, belts and so on.
- (5)
  - (a) Feel the patient's pulse.
  - (b) Check the heartbeat by bringing your ear close to the patient's heart.
  - (c) Check for respiration by bringing your face or the back of your hand to the patient's face.
  - (d) Check the size of patient's pupils.
- (6) Opening the patient's mouth, remove artificial teeth, cigarettes, chewing gum, etc. if any. With the patient's mouth open, stretch the tongue and insert a towel or the like into the mouth to prevent the tongue from being withdrawn into the throat. (If the patient clenches the teeth so tight that the mouth won't open, use a screwdriver or the like to force the mouth open and then insert a towel or the like into the mouth.)
- (7) Wipe off the mouth to prevent foaming mucus and saliva from accumulating.

# ★ Treatment to Give When the Patient Has a Pulse Beating but Has Ceased to Breathe

\* Performing mouth-to-mouth artificial respiration - Fig. 1

- (1) Bend the patient's face backward until it is directed to look back. (A pillow may be placed under the neck.)
- (2) Pull up the lower jaw to open up the airway. (To spread the airway)
- (3) Pinching the patient's nose, breathe deeply and blow your breath into the patient's mouth strongly, with care to close it completely. Then, move your mouth away and take a deep breath, and blow into his or her mouth. Repeat blowing at 10 to 15 times a minute (always with the patient's nostrils closed).
- (4) Continue artificial respiration until natural respiration is restored.
- (5) If the patient's mouth won't open easily, insert a pipe, such as one made of rubber or vinyl, into either nostril. Then, take a deep breath and blow into the nostril through the pipe, with the other nostril and the mouth completely closed.
- (6) The patient may stand up abruptly upon recovering consciousness. Keep the patient lying calmly, giving him or her coffee, tea or any other hot drink (but not alcoholic drink) to keep him or her warm.

Mouth-to-mouth artificial respiration with the patient's head lifted

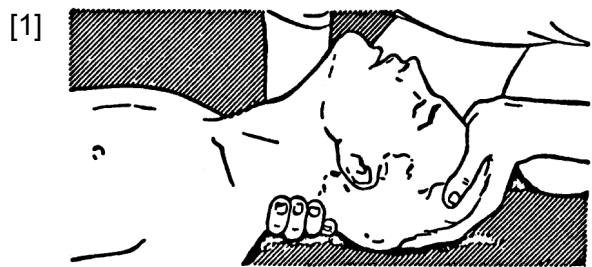

- (1) Lift the back part of the patient's head. Support the forehead with one of your hand and the neck with the other hand. → [1].

Many patients will have their airways opened by lifting their head in this way to ease mouth-to-mouth artificial respiration.

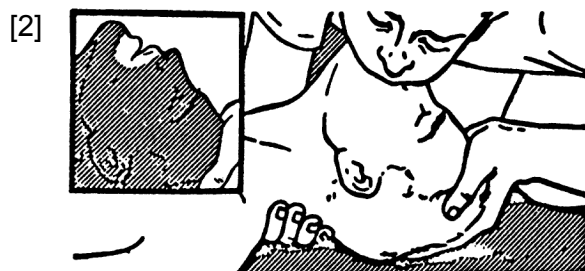

- (2) Closing the patient's mouth with your mouth, press your cheek against the patient's nose → [2]. Alternatively, hold the patient's nose with your finger to prevent air leak → [3].

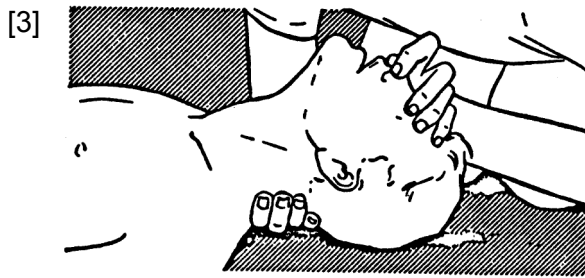

- (3) Blowing air into the patient's lungs. Blow air into the patient's lungs until chest is seen to rise. The first 10 breaths must be blown as fast as possible.

Fig. 1 Mouth-to-mouth artificial respiration

## ★ Treatment to Give When the Patient Has No Pulse Beating and Has Ceased to Breathe

### \* Performing cardiac massage - Fig. 2

If the patient has no pulse beating, with the pupils open and no heartbeat being heard, the patient has a cardiac arrest and requires immediate artificial respiration. Continue this until a medical specialist arrives, and follow his or her directions after that.

- (1) Putting one hand on about the lower one third of the patient's ribs and the other hand over the back of the first, with your elbow fully stretched (with bended elbow, you can't press to the extent the patient's ribs are depressed), apply your body weight to the hands to press the patient's body until it is depressed about 2 cm (Repeat this about 50 times a minute). (Cardiac massage)
- (2) If only one first-aider is available, perform a cardiac massage about 15 times and then give mouth-to-mouth artificial respiration 2 times. Repeat this sequence.  
  
If two first-aiders are available, while one person performs a cardiac massage 15 times, the other should give mouth-to-mouth artificial respiration 2 times. Repeat this sequence. (Combined cardiac massage and mouth-to-mouth artificial respiration method)
- (3) Check the patient's pupils and feel the pulse from time to time. When the pupils are restored to normal and the pulse begins to beat regularly, stop treating and keep the patient calm while giving him or her coffee, tea or any other hot drink to keep him or her warm while watching him or her carefully.

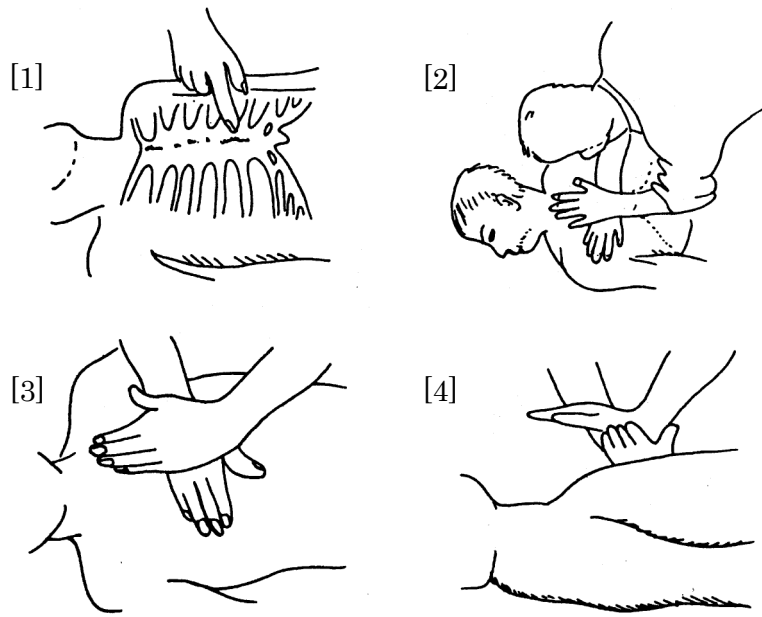
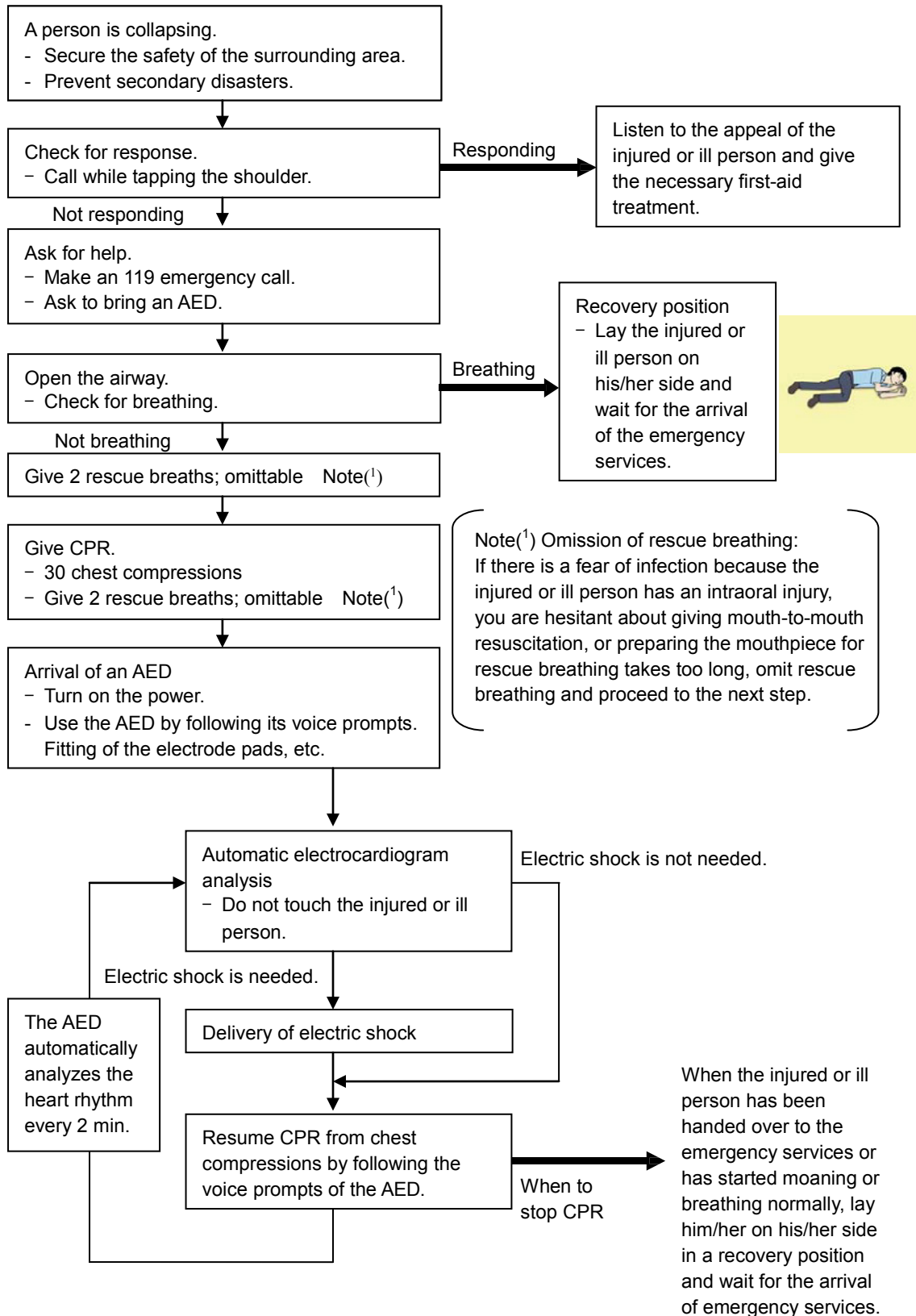

Fig. 2 Cardiac massage



# Procedure for cardiopulmonary resuscitation (CPR) using the AED (Automated External Defibrillator)



# Procedure for Cardiopulmonary Resuscitation (CPR) Using the AED (Automated External Defibrillator)

## 1. Check the scene for safety to prevent secondary disasters

- a) Do not touch the injured or ill person in panic when an accident has occurred. (Doing so may cause electric shock to the first-aiders.)
- b) Do not panic and be sure to turn off the power. Then, gently move the injured or ill person to a safe place away from the electrical circuit.

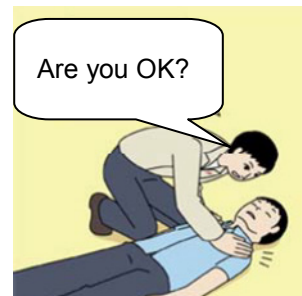

## 2. Check for responsiveness

- a) Tap the shoulder of the injured or ill and shout in the ear saying, "Are you OK?"
- b) If the person opens his/her eyes or there is some response or gesture, determine it as "responding." But, if there is no response or gesture, determine it as "not responding."

## 3. If responding

- a) Give first-aid treatment.

## 4. If not responding

- a) Ask for help loudly. Ask somebody to make an emergency 119 call and bring an AED.
  - Somebody has collapsed. Please help.
  - Please call **119**.
  - Please bring an **AED**.
  - If there is nobody to help, call 119 yourself.

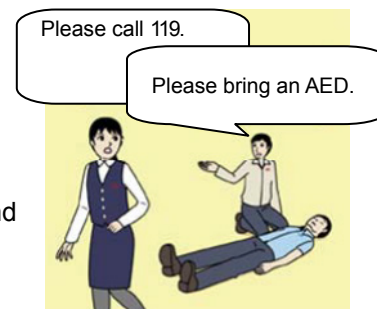

## 5. Open the airway

- a) Touch the forehead with one hand. Lift the chin with the two fingers of the middle finger and forefinger of the other hand and push down on the forehead as you lift the jaw to bring the chin forward to open the airway. If neck injury is suspected, open the airway by lifting the lower jaw.

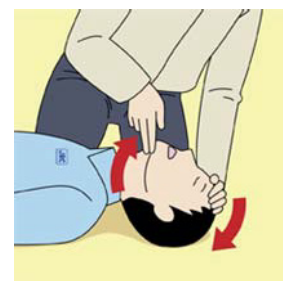

## 6. Check for breathing

a) After opening the airway, check quickly for breathing for no more than 10 seconds. Put your cheek down by the mouth and nose area of the injured or ill person, look at his/her chest and abdomen, and check the following three points.

- Look to see if the chest and abdomen are rising and falling.
- Listen for breathing.
- Feel for breath against your cheek.

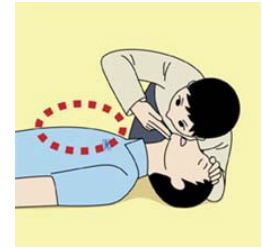

b) If the injured or ill person is breathing, place him/her in the recovery position and wait for the arrival of the emergency services.

- Position the injured or ill person on his/her side, maintain a clear and open airway by pushing the head backward while positioning their mouth downward. To maintain proper blood circulation, roll him/her gently to position them in the recovery position in the opposite direction every 30 minutes.

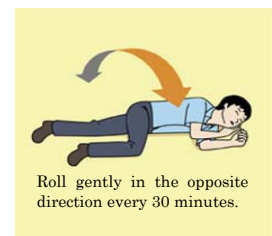

## 7. Give 2 rescue breaths (omittable)

a) If opening the airway does not cause the injured or ill person to begin to breathe normally, give rescue breaths.

b) If there is a fear of infection because the injured or ill person has an intraoral injury, you are hesitant about giving mouth-to-mouth resuscitation, or getting and preparing the mouthpiece for rescue breathing takes too long, omit rescue breathing and perform chest compressions.



c) When performing rescue breathing, it is recommended to use a mouthpiece for rescue breathing and other protective devices to prevent infections.

d) While maintaining an open airway, pinch the person's nose shut with your thumb and forefinger of the hand used to push down the forehead.

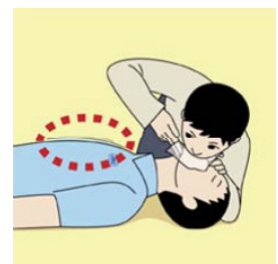

e) Open your mouth widely to completely cover the mouth of the injured or ill person so that no air will escape. Give rescue breathing twice in about 1 second and check if the chest rises.

## 8. Cardiopulmonary resuscitation (CPR) (combination of chest compressions and rescue breaths)

### a) Chest compressions

#### 1) Position of chest compressions

- Position the heel of one hand in the center of the chest, approximately between the nipples, and place your other hand on top of the one that is in position.

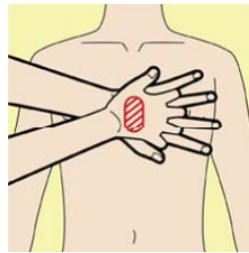
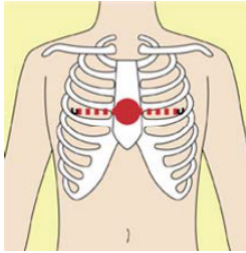

#### 2) Perform chest compressions

- Perform uninterrupted chest compressions of 30 at the rate of about 100 times per minute
- While locking your elbows positioning yourself vertically above your hands.
- With each compression, depress the chest wall to a depth of approximately 4 to 5 cm.



### b) Combination of 30 chest compressions and 2 rescue breaths

#### 1) After performing 30 chest compressions, give 2 rescue breaths.

If rescue breathing is omitted, perform only chest compressions.

#### 2) Continuously perform the combination of 30 chest compressions and 2 rescue breaths without interruption.

#### 3) If there are two or more first-aiders, alternate with each other approximately every two minutes (five cycles of compressions and ventilations at a ratio of 30:2) without interruption.

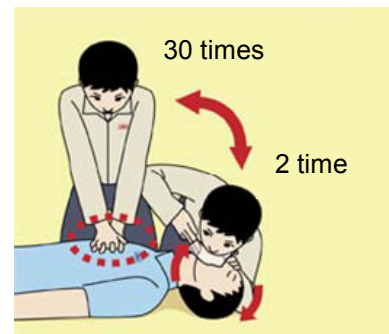

**9. When to stop cardiopulmonary resuscitation (CPR)**

- a) When the injured or ill person has been handed over to the emergency services
- b) When the injured or ill person has started moaning or breathing normally, lay him/her on his/her side in a recovery position and wait for the arrival of emergency services.

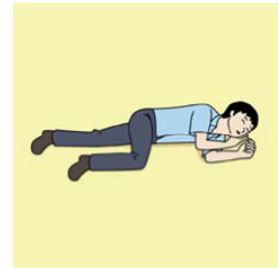

**10. Arrival and preparation of an AED**

- a) Place the AED at an easy-to-use position. If there are multiple first-aiders, continue CPR until the AED becomes ready.
- b) Turn on the power to the AED unit. Depending on the model of the AED, you may have to push the power on button, or the AED automatically turns on when you open the cover.
- c) Follow the voice prompts of the AED.

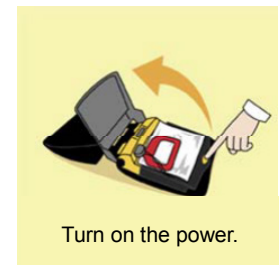
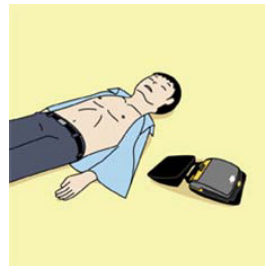

**11. Attach the electrode pads to the injured or ill person's bare chest**

- a) Remove all clothing from the chest, abdomen, and arms (male or female).
- b) Open the package of electrode pads, peel the pads off and securely place them on the chest of the injured or ill person, with the adhesive side facing the chest. If the pads are not securely attached to the chest, the AED may not function. Paste the pads exactly at the positions indicated on the pads. If the chest is wet with water, wipe dry with a dry towel and the like, and then paste the pads. If there is a pacemaker or implantable cardioverter defibrillator (ICD), paste the pads at least 3cm away from them. If a medical patch or plaster is present, peel it off and then paste the pads. If the injured or ill person's chest hair is thick, paste the pads on the chest hair once, peel them off to remove the chest hair, and then paste new pads.
- c) Some AED models require to connect a connector by following voice prompts.
- d) Do not put child pads on adults (older than 8 years).

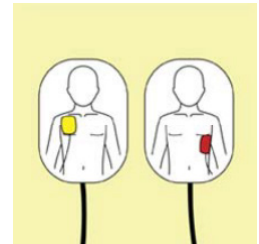

## 12. Electrocardiogram analysis

- a) The AED automatically analyzes electrocardiograms. Follow the voice prompts of the AED and ensure that nobody is touching the injured or ill person while you are operating the AED.
- b) On some AED models, you may need to push a button to analyze the heart rhythm.



## 13. Electric shock (defibrillation)

- a) If the AED determines that electric shock is needed, the voice prompt saying, "Shock is needed" is issued and charging starts automatically.
- b) When charging is completed, the voice prompt saying, "Push the shock button" is issued and the shock button flashes.
- c) The first-aider must get away from the injured or ill person, make sure that no one is touching him/her, and then press the shock button.
- d) When electric shock is delivered, the body of the injured or ill person may jerk.

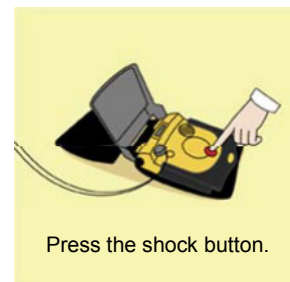

## 14. Resume cardiopulmonary resuscitation (CPR).

Resume CPR consisting of 30 chest compressions and 2 rescue breaths by following the voice prompts of the AED.



## 15. Automatic electrocardiogram analysis

- a) When 2 minutes have elapsed since you resumed cardiopulmonary resuscitation (CPR), the AED automatically analyzes the electrocardiogram.
- b) If you suspended CPR by following voice prompts and AED voice prompt informs you that shock is needed, give electric shock again by following the voice prompts.  
If AED voice prompt informs you that no shock is needed, immediately resume CPR.

**16. When to stop CPR (Keep the electrode pads on.)**

- a) When the injured or ill person has been handed over to the emergency services
- b) When the injured or ill person has started moaning or breathing normally, lay him/her on his/her side in a recovery position and wait for the arrival of emergency services.

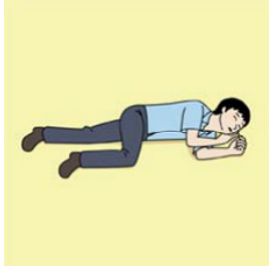

**PREFACE**

- For copy and transcription of this Instruction Manual (hereinafter referred to as this manual), permission from JRC is needed. JRC prohibits the un-authorized copy and transcription of this manual.
- If this manual is lost or damaged, consult a dealer of JRC or JRC.
- The specification of the products and the contents in this manual are subject to change without notice.
- The contents displayed on the menu of product may be different from the expression of this manual. The fonts and shapes of the keys and menus in the illustration may differ from the actual ones, and some parts may be omitted.
- JRC is not liable for damages and troubles arisen from misunderstanding of the contents in this manual.
- JRC is not liable for any damages caused by earthquake, lightning, wind and flood damage and fire for which JRC is not responsible, and actions by third parties, other accidents, customer's unintended error/abuse and the use under other abnormal conditions.
- JRC is not liable for damages of accompaniment (change/loss of memorized content, loss of business profit, stop of business) arisen from use or failure of our products.
- If the stored data are changed or lost, irrespective of causes of troubles and damages, JRC is not liable for them.
- JRC is not liable for any damages arisen from malfunction caused by combination of software and connected equipment in which JRC is not engaged.

If there was an offer from the other ships for interference mitigation, in the order of the wideband echo sounder, the echo sounder using multiple frequency and the echo sounder using a single frequency, please take measures of change of use frequency and the reduction of the transmitting sound pressure level.

Changing the use frequency, refer to Instruction Manual [Advanced] "1.4 Change of TX Power".





**Before Operation**

**Pictorial Indication**

Various pictorial indications are included in this instruction manual and are shown on this equipment so that you can operate them safely and correctly and prevent any danger to you and / or to other persons and any damage to your property during operation. Such indications and their meanings are as follows.

Please understand them before you read this manual:

 <p><b>DANGER</b></p>	<p>This indication is shown where incorrect equipment operation due to negligence may cause death or serious injuries.</p>
 <p><b>WARNING</b></p>	<p>This indication is shown where any person is supposed to be in danger of being killed or seriously injured if this indication is neglected and these equipment are not operated correctly.</p>
 <p><b>CAUTION</b></p>	<p>This indication is shown where any person is supposed to be injured or any property damage is supposed to occur if this indication is neglected and these equipment are not operated correctly.</p>

**Examples of Pictorial Indication**



Electric Shock

The  $\triangle$  mark represents CAUTION (including DANGER and WARNING). Detailed contents of CAUTION ("Electric Shock" in the example on the left) is shown in the mark.



Disassembling Prohibited



The  $\otimes$  mark represents prohibition. Detailed contents of the prohibited action ("Disassembling Prohibited" in the example on the left) is shown in the mark.



Disconnect the power plug



The  $\bullet$  mark represents instruction. Detailed contents of the instruction ("Disconnect the power plug" in the example on the left) is shown in the mark.

**Warning Label**

There is a warning label on the top cover of the equipment.  
Do not try to remove, break or modify the label.

**Precautions upon Equipment Operation**

 **DANGER**

**Cautions on handling**



In case of smoking or firing, switch off the power in the boat and of this equipment. It may lead to firing, electric shock or damages.



Electric Shock

**Be careful of residual high voltage**

High voltage may remain in capacitors for several minutes after switching off the power. Before inspection of the inside, please wait at least 5 minutes after switching off or discharge the residual electricity in an appropriate manner. Then, start the work.

 **WARNING**

**Cautions on handling**



No disassembly or modification of this equipment is allowed. It may lead to failure, firing, smoking or electric shock. In case of failure, please contact JRC's dealers or JRC.

# CAUTION

## Cautions on handling



The information displayed on this equipment is not intended to use for your navigation. For your navigation, be sure to see the specified materials.



Please use the specified fuses. If un-specified fuses are used, they may cause firing, smoking or damages.



Be sure to submerge the transducer in water before transmission. If not, it may be damaged.

## Contents

Caution .....	i
PREFACE .....	xiv
Before Operation.....	xv
Pictorial Indication.....	xv
Examples of Pictorial Indication.....	xv
Warning Label .....	xv
Precautions upon Equipment Operation.....	xvi
Contents .....	xviii
<b>Chapter 1 Preparation .....</b>	<b>1-1</b>
1.1 Introduction .....	1-1
1.2 Features.....	1-1
1.3 Configuration of Equipment.....	1-2
1.4 System Diagram .....	1-5
1.5 To use keys.....	1-6
1.6 Power On/Off .....	1-8
1.6.1 Power On.....	1-8
1.6.2 Power Off.....	1-9
1.6.3 Power Voltage Alarm .....	1-9
1.7 Selection of language to be displayed.....	1-9
1.8 To use Menu .....	1-10
1.8.1 Open/Close the Menu .....	1-10
1.8.2 Operation of the Menu.....	1-11
1.8.3 Open/Close of Submenu .....	1-13
1.8.4 Operation of SUBMENU.....	1-14
1.9 To read echo sounder's screen .....	1-16
1.10 Adjustment of brilliance for comfortable viewing .....	1-19
1.10.1 Adjustment of panel brilliance .....	1-19
<b>Chapter 2 Basic operation .....</b>	<b>2-1</b>
2.1 Switch screen images (Setting up of CM menu).....	2-1
2.1.1 Display of 1-frequency/displays of 2-frequency and more.....	2-1
2.1.2 Setting frequency to match the transducer to be used.....	2-3
2.1.3 Displaying of zoom images.....	2-6
2.1.4 Display of mixed images.....	2-15
2.1.5 Selection of pulse length.....	2-19
2.1.6 Selection of frequency bandwidth.....	2-22
2.1.7 Selection of gain adjustment method.....	2-25
2.2 Adjustment of echo sounder.....	2-26
2.2.1 Switching of depth range mode.....	2-26
2.2.2 Switching of Normal/Zoom for range and shift operation.....	2-28
2.2.3 Manual change of a range for normal image.....	2-29
2.2.4 Manual change of shift positions of normal images.....	2-36
2.2.5 Adjustment of image gain .....	2-46
2.2.6 Adjustment of TVG.....	2-55
2.3 Changing of the image scroll speed .....	2-67
2.4 Finding out depth of targets in images (VRM operation).....	2-69
2.4.1 Changing of VRM follow interval.....	2-70

2.4.2	Operation of VRM in Active Screen .....	2-72
2.4.3	Operation of VRM on all Screens.....	2-74
2.5	Reduction of noise on images .....	2-76
2.5.1	To reject interference.....	2-76
2.5.2	To erase the weak response from dust and plankton, etc. ....	2-80
2.5.3	To reduce noise .....	2-85
<b>Chapter 3 To make the best of [CM] keys .....</b>		<b>3-1</b>
3.1	To use [CM] keys .....	3-1
3.1.1	To use [CM] key for switching screen modes .....	3-2
3.1.2	To use [CM] keys as one touch switch to the memorized setting to the fishing positions .....	3-6
3.1.3	Use [CM] keys as screen mode switching and one touch switch of setting.....	3-10
<b>Chapter 4 Useful operation .....</b>		<b>4-1</b>
4.1	Temporary change of images for better view .....	4-1
4.2	Use function keys ([F1]/[F2]) .....	4-1
4.2.1	To use function keys ([F1]/[F2]) .....	4-1
4.2.2	Assign intended operation to function keys ([F1]/[F2]) .....	4-2
4.3	Switching of range mode.....	4-3
4.3.1	Switch to manual operation .....	4-3
4.3.2	Setting of auto range .....	4-4
4.3.3	Setting of auto shift.....	4-6
4.4	To use event key .....	4-8
4.4.1	Registration of waypoints .....	4-8
4.4.2	To store images.....	4-8
4.4.3	Starting up Homing.....	4-9
4.4.4	Selection of event key function .....	4-10
4.5	Shortcut to range registration menu .....	4-12
4.6	To move the position of menu .....	4-13
<b>Chapter 5 Maintenance and Inspection.....</b>		<b>5-1</b>
5.1	Inspection .....	5-1
5.2	Cleaning .....	5-1
5.2.1	Display unit.....	5-1
5.2.2	Transducer.....	5-2
5.3	Fuse Replacement.....	5-2
5.4	Troubleshooting .....	5-3
<b>Chapter 6 Specifications .....</b>		<b>6-1</b>
<b>Chapter 7 Outline Drawing.....</b>		<b>7-1</b>
<b>Chapter 8 Index.....</b>		<b>8-1</b>



## Chapter 1 Preparation

### 1.1 Introduction

JFC-180BB is the Black Box type without the display unit, for which customer can select the display monitor of preference. The external monitor and connecting cable are user supply.

This unit equipped with the latest digital process can accurately display circumstances in the water under all conditions.

### 1.2 Features

The main features of this unit are as follows:





- This unit is a multi-frequency echo sounder with broadband transducers.
- With a simple operation on a menu, frequencies up to 4 can be optionally set within a wide range.
- With digital reception processing, the high resolution in shallow depth and the noise reduction capability in deep depth are both attainable. In addition, optimum images can be displayed by the auto mode function.
- Sona-Tone™ (Sonar sound) function provides fish school status by sound.
- Up to 500 graphic images can be stored. Homing function is available by pushing event key while recalling the stored images, to provide navigation guidance to the designated position (optional GPS is required).
- Various alarm functions are available (Bottom, school of fish, water temperature\*, vessel speed\*, arrival\*, XTE\*, power source).

(Note: The mark \* denotes that the connection of optional sensors is required)

- The operation units can be easily installed from the front side by flush mounting.
- RGB analog output to an external monitor is provided as standard. The use of external monitor enables to observe the echo sounder images from the place distant from the main unit (External monitor is owner supply).
- The data for image, waypoint, and setting can be backed up in the USB memory and the SD card, to be recalled later.
- As the operation unit is separated, operation away from the processor and the display units is possible.

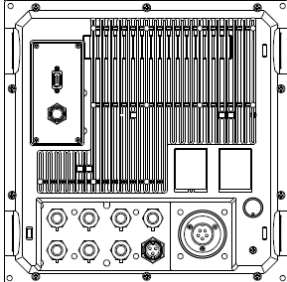
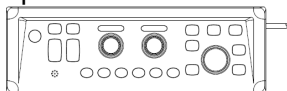
### 1.3 Configuration of Equipment

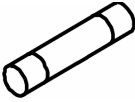
Standard Equipment Configuration List of JFC-180BB

No.	Name of item	Type	Remark	Weight/ Length	Qty
1	Processor unit 	NCM-1810J/E	J : Japanese edition E : English edition	5.6kg	1
2	Operation unit 	NCH-1800J/E	J : Japanese edition E : English edition Mounting bracket and attachment cable CW-409-5M	0.7kg/ 5m	1
3	DC power cable 	CW-270-2M	With 5-pin connector and one end plain	2 m	1
4	Fuse 	F-7161-10A/ N30C-125 V type(φ6.4 × 30)	Normal fusion type for main power		2
5	Junction Box	JB-34-JRC	Transducer junction box		1
6	Connector 	LTWBD-06BFFA-L 180	6-pin water resistant connector		2
7	Transducer (Not included in the body components)	Please arrange separately choose Refer to “ Type of transducer ” ( page 1-3)	Transducer cable		-
8	Instruction Manual [Basic]	7ZPNA4617A	English		1
9	Instruction Manual [Advanced]	7ZPNA4619A	English		1
10	Quick Reference	7ZPNA4633	English		1
11	Installation manual	7ZPNA4623A	English		1
12	NMEA Input / Output cable	CW-376-5M	With a 6-pin water resistant connector & one end plain	5m	1
13	External monitor connection cable	CW-576-0.5M	With connector & Output side mini D-sub 15-pin	0.5m	1
14	Transducer cable	CW-836-3M	With 5-pin connector and one end soldering to insert to JB	3 m	1
		CW-844-3M	For connection of water temp. and speed sensors	3 m	1

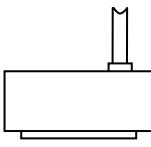
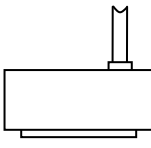

Type of transducer (Select from the following. TDM-052A is the standard selection equipment)

No.	Specification	Frequency output	Material/ Cable length/ Cable diameter	Mounting method	Beam width (- 6 dB) (Right and left x Back and forth)(-6 dB)
1	TDM-052A 	Low frequency 38 to 75 kHz  High frequency 130 to 210 kHz	Rubber mold 15 m φ11	Ship's bottom	Low frequency (38 kHz) 27° × 14° (60 kHz) 18° × 10° (75 kHz) 14° × 7° High frequency (130 kHz) 11° (170 kHz) 8° (210 kHz) 7°
2	TDM-062A 	Low frequency 38 to 75 kHz  High frequency 85 to 135 kHz	Rubber mold 15 m φ11	Ship's bottom	Low frequency (38 kHz) 27° × 14° (60 kHz) 18° × 10° (75 kHz) 14° × 7° High frequency (85 kHz) 17° (100 kHz) 13° (135 kHz) 10°



**Caution:** Broadband transducer (TDM-052A, TDM-062A) shall not be operated in the air, as it will be damaged.

## Option List

No.	Name of Item	Specification	Remark	Weight/ Length
1	Transducer extension cable	C44-02	Cable configuration is the same as TDM-052A/ TDM-062A. (Refer to Installation manual "Connection of transducer", page 1-29)	Specify length at order
2	Grounding cable	OW7/1.6S-3M		3 m
3	Connecting cable	CW-371-5M	With a 5-pin connector & a 5-pin water resistant connector	5 m
		CW-372-5M	With a 5-pin water resistant connector & one end plain	5 m
		CW-373-5M	With 6-pin water resistant connectors both ends	5 m
		CW-374-5M	With a 6-pin connector & a 6-pin water resistant connector	5 m
		CW-376-5M	With a 6-pin water resistant connector & one end plain	5 m
		CW-410-5M	With 6-pin water resistant connectors both ends & the shield wire connected to only one connector unlike other wires	5m
		CW-560-2M	With 15-pin water resistant D-Sub connectors both ends	2 m
		CW-264A-2M	12-pin waterproof connector at one end / $\phi$ 3.5 stereo jack at one end	2 m
		CW-405-0.3M	Junction cable for CCD camera	0.3 m
		CW-409-2m	Connection cable for Operation unit	2m
CW-409-10m	10m			
4	Connector	LTWBD-05BFFA-L180	5-pin water resistant connector	
		LTWBD-06BFFA-L180	6-pin water resistant connector	
5	Transmission filter	Transmission C29EHB004A	Filter against leakage from wireless equipment	

1.4 System Diagram

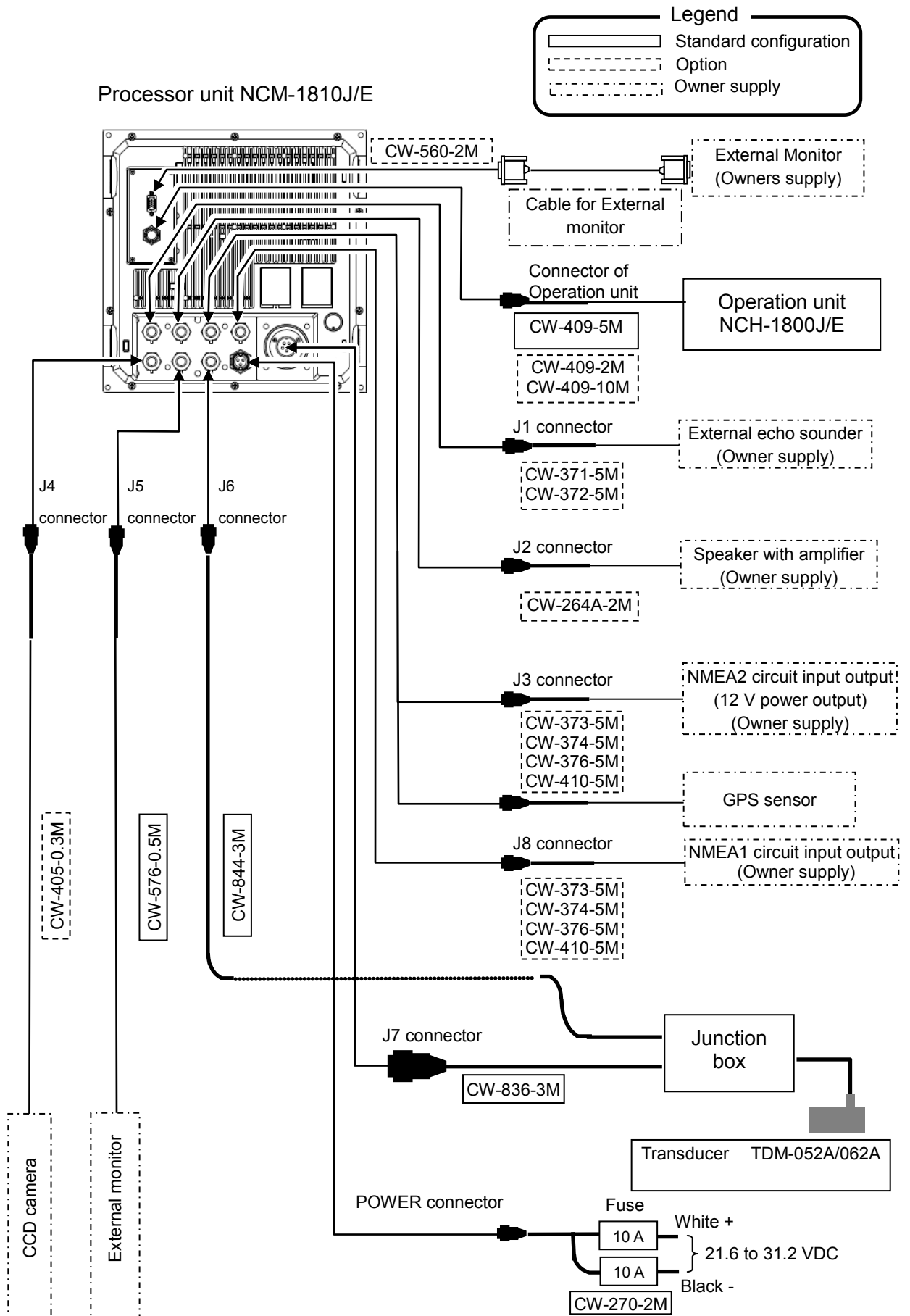

1.5 To use keys

Operation unit of JFC-180BB

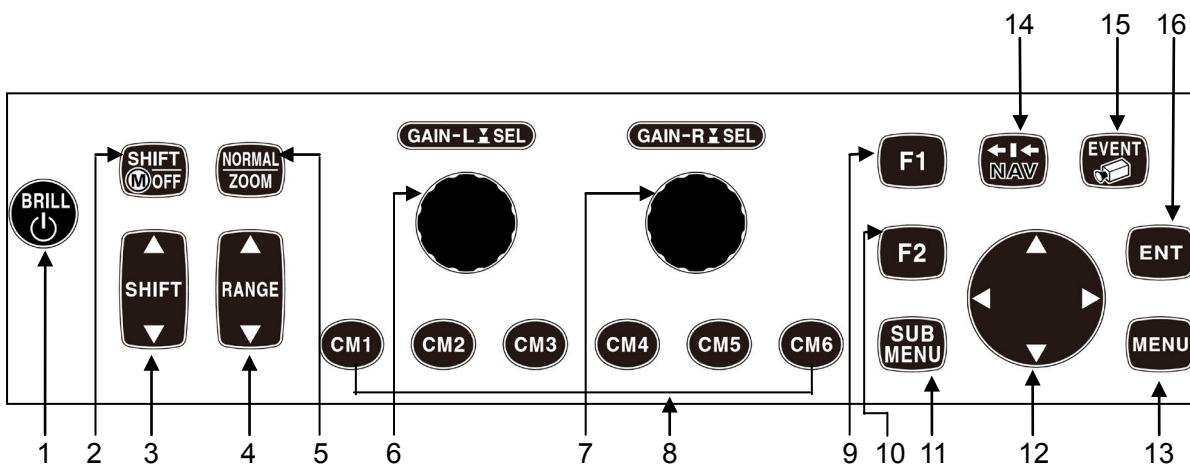

NO.	Key Name	Description
1	[BRILL	Press: Power on. Adjusts brilliance of the panel. Long-press: Power off.
2	[SHIFT/	Press: Switches ON/OFF of Shift Long-press: Changes of range mode (Auto range/Manual/Auto Shift)
3	[SHIFT	Changes the shift position setting.
4	[RANGE	Changes the range setting.
5	[NORMAL/ZOOM]	Press: Switches NORMAL/ZOOM assignment of [RANGE] [SHIFT] keys. Long-press: Short-cut to the range setting menu.
6	[GAIN-L/SEL] (Gain knob)	Rotate: Gain adjustment at low frequency side Press: Switches of operation screen at low frequency side
7	[GAIN-R/SEL] (Gain knob)	Rotate: Gain adjustment at high frequency side Press: Switches of operation screen at high frequency side
8	[CM1]...[CM6]	Press: Recalls CM (CM: Condition Memory. See P2-1) Switches screen modes Long-press: Starts copy of CM
9	[F1] (Function key 1)	Press: Recalls directly the item registered. Long-press: Selects and saves the item to register
10	[F2] (Function key 2)	Press: Recalls directly the item registered. Long-press: Selects and saves the item to register.
11	[SUB MENU]	Opens/Closes the Submenu. Return to the Menu of the previous operation
12	[CURSOR]	Selects item of Menu/Submenu Changes the setting values for the Menu/Submenu. Moves the markers (VRM, event). Changes the Shift.
13	[MENU]	Press: Opens/Closes the Menu. Closes submenu and control boxes. Long-press: Activates function to move Menu/Submenu position on the screen.



14	[←   ←/NAV]	Press: Changes the image scroll speed. Long-press: Displays the navigation screen.
15	[EVENT]	Press: Outputs the present position or the event cursor position in TLL sentences. Store image. Starts homing. Long-press: Displays the images of CCD camera.
16	[ENT]	Ends input of setting value digits for Menu/submenu. Temporary erasing of displayed items on screen.

There are two types of pressing of keys, which are Press and Long-press.

1. Press: Press the key and release immediately.
2. Long-press: Keep pressed until the screen display responds.

Normal operation is done with [Press].

When the relevant key is long-pressed, the control box of the function defined for the key is displayed. Release the key immediately, once the control box is displayed.

[GAIN-L/SEL] knob  and [GAIN-R/SEL] knob  are the knobs for gain control.

Operation of the gain knobs are in two ways, [Rotate] and [Press].

1. Rotate: Turn the knob clockwise or anticlockwise
2. Press: Press the top of the knobs.

## 1.6 Power On/Off

### 1.6.1 Power On

Press the [BRILL $\odot$ ] key  to power on.

The start-up screen is displayed. On start-up, the internal memory (ROM and RAM) is automatically checked. If the checking completes normally, the message is displayed as below.

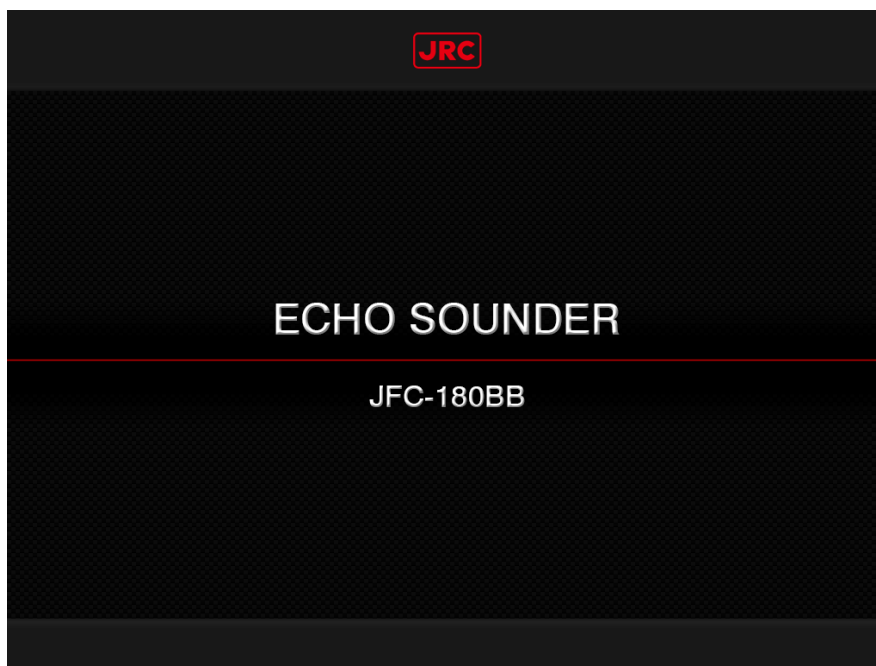

**Caution:** If an error occurs during the memory check, LEDs on the operation panel blink to indicate possible failure of the unit. In this case, please contact a dealer of JRC or JRC.



**Caution:** Please wait until the echo sounder screen is displayed after the power is turned on. It takes about 30 seconds.



**Caution:** You may not be able to operate keys when the onboard power supply is momentarily lost or interrupted. Please wait for recovery which takes approximately one minute.

Please turn on the power again, in case you do not see recovery after one minute.

Please take the following steps to recover power supply:

- 1) Please turn off the power supply in accordance with 1.6.2 Power Off.
- 2) Please turn on the power supply in accordance with 1.6.1 Power On.

### 1.6.2 Power Off

Keep pressing the [BRILL] key  for 3 seconds to power off. After countdown for power shut down, when the indication below is displayed, release the key immediately. After 15 seconds, power is switched off automatically.

Please wait for a while.  
Power shutdown process in progress.

### 1.6.3 Power Voltage Alarm

When nonstandard power voltage is detected, the icon  starts blinking and generates alarm.

 **Caution:** The power will be automatically switched off when the voltage is low (8.5 V or lower) or high (34 V or higher). The accuracy of power voltage indication is  $\pm 0.5$  V.

### 1.7 Selection of language to be displayed

When the power is switched on for the first time after installation, the following [Language] screen is displayed.



Select a language using [▲] key or [▼] key of .

To decide the language, press [MENU] key .

 **Caution:** There are the other languages than English and Japanese for selection.

**1.8 To use Menu**

JFC-180BB have two kinds of menu, [MENU] and [SUBMENU].  
The operation of the both menus is basically the same.

**1.8.1 Open/Close the Menu**

To display the menu, press the [MENU] key .

List of menu items, message boxes of operation guide and function guide are displayed as shown below:

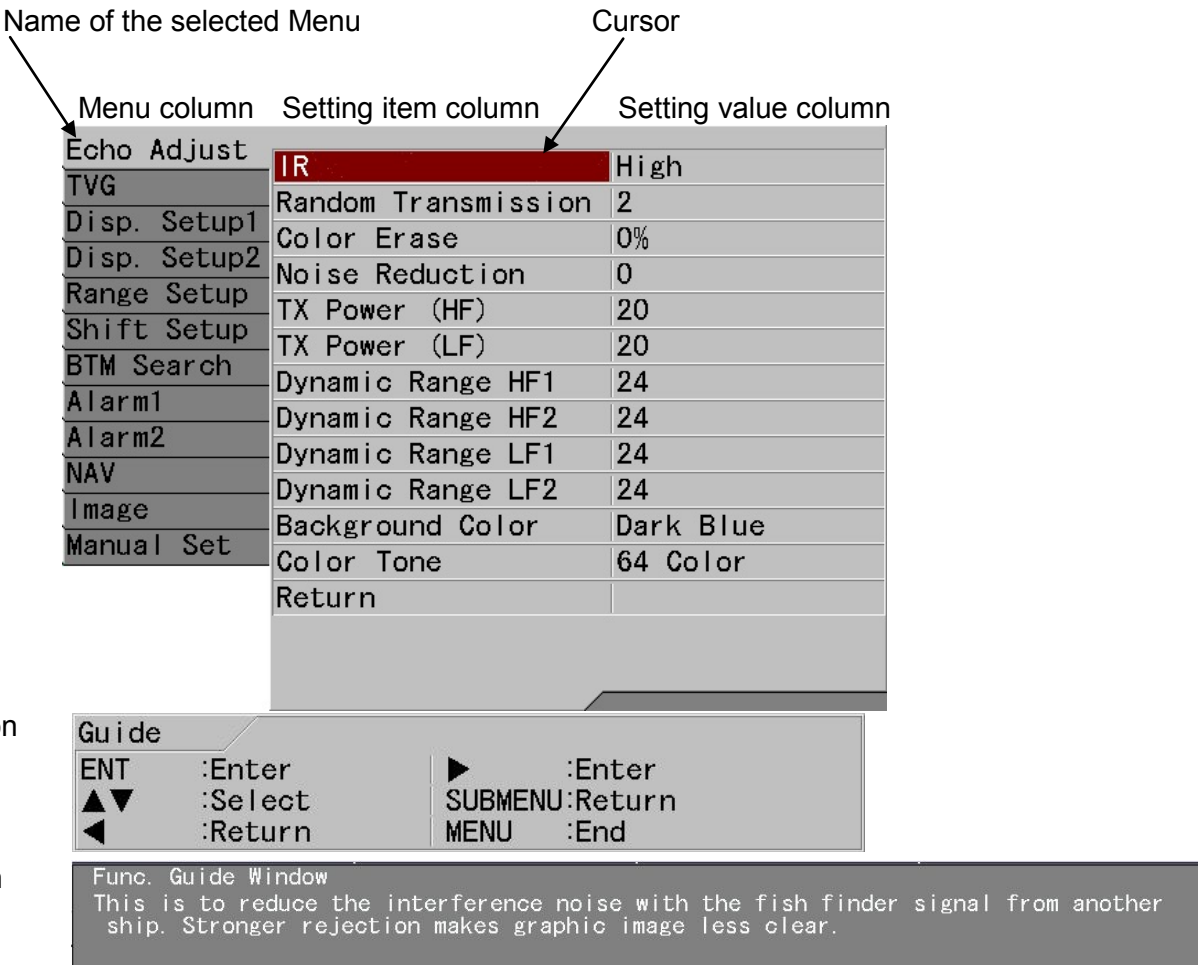

The screenshot shows a menu interface with three columns: 'Menu column', 'Setting item column', and 'Setting value column'. The 'IR' item is selected in the 'Setting item column'. Below the menu is an 'Operation guide' box with key functions: ENT (Enter), arrow keys (Select), and left arrow (Return). To the right of the operation guide is a 'Func. Guide Window' with text: 'This is to reduce the interference noise with the fish finder signal from another ship. Stronger rejection makes graphic image less clear.'

Menu column	Setting item column	Setting value column
Echo Adjust	IR	High
TVG	Random Transmission	2
Disp. Setup1	Color Erase	0%
Disp. Setup2	Noise Reduction	0
Range Setup	TX Power (HF)	20
Shift Setup	TX Power (LF)	20
BTM Search	Dynamic Range HF1	24
Alarm1	Dynamic Range HF2	24
Alarm2	Dynamic Range LF1	24
NAV	Dynamic Range LF2	24
Image	Background Color	Dark Blue
Manual Set	Color Tone	64 Color
	Return	

**Operation guide**

ENT	:Enter	▶	:Enter
▲▼	:Select	SUBMENU	:Return
◀	:Return	MENU	:End

**Function guide**

Func. Guide Window  
This is to reduce the interference noise with the fish finder signal from another ship. Stronger rejection makes graphic image less clear.

The operation guide is displayed when [SUBMENU], [System] and [Guide Window] are all on. (See the Instruction Manual [Advanced] “5.2.1 Display/No display of Guide Window”)  
The function guide is displayed when [SUBMENU], [System] and [Func. Guide Window] are all on. (See the Instruction Manual [Advanced] “5.2.2 Display/No display of Func. Guide Window”)

To close the menu, press [MENU] key .

The [MENU], [Guide Window] and [Func. Guide Window] on the screen disappear.



### 1.8.2 Operation of the Menu

Press [▲] key or [▼] key of  to select a menu item while Menu is displayed.

List of the setting items changes to the corresponding contents with the selected menu item.

Menu column	Setting item column	Setting value column
Echo Adjust	IR	High
TVG	Random Transmission	2
Disp. Setup1	Color Erase	0%
Disp. Setup2	Noise Reduction	0
Range Setup	TX Power (HF)	20
Shift Setup	TX Power (LF)	20
BTM Search	Dynamic Range HF1	24
Alarm1	Dynamic Range HF2	24
Alarm2	Dynamic Range LF1	24
NAV	Dynamic Range LF2	24
Image	Background Color	Dark Blue
Manual Set	Color Tone	64 Color
	Return	

Press [▶] key of .

Then, a cursor appears in the Setting item column.

Menu column	Setting item column	Setting value column
Echo Adjust	<b>IR</b>	High
TVG	Random Transmission	2
Disp. Setup1	Color Erase	0%
Disp. Setup2	Noise Reduction	0
Range Setup	TX Power (HF)	20
Shift Setup	TX Power (LF)	20
BTM Search	Dynamic Range HF1	24
Alarm1	Dynamic Range HF2	24
Alarm2	Dynamic Range LF1	24
NAV	Dynamic Range LF2	24
Image	Background Color	Dark Blue
Manual Set	Color Tone	64 Color
	Return	

Press [▲] key or [▼] key of  to select the item to change.

Press [▶] key of , and the setting box appears with the corresponding selection items.

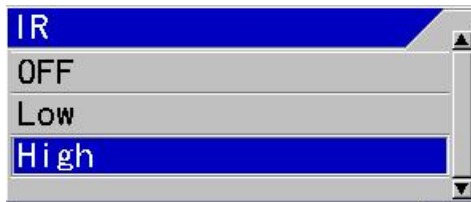



Press [▲] key or [▼] key of , to change the setting.

Press [◀] key of  or [SUBMENU] key . Then, the cursor returns to the setting item column.

To return to the menu column, press [◀] key of  or [SUBMENU] key .

Then, the cursor returns to the menu column.

Press [MENU] key  to close the menu.

 **Caution:** Menu disappears when [MENU] key  is pressed during menu operation.

**1.8.3 Open/Close of Submenu**

To display the Submenu, press the [SUBMENU] key .

List of Submenu items, operation guide box and function guide box are displayed as shown below:

Name of the selected menu                      Cursor

Menu column	Setting item column	Setting value column
System	<b>Event Key Usage</b>	Store Image
Source	FUNC1.Key Setting	Image Title
NMEA 1	FUNC2.Key Setting	IR
NMEA 2	Guide Window	ON
Correct	Func. Guide Window	ON
Heaving	Header Display	ON
TD Setting	Simple Menu	OFF
Basics	CM Key Usage	CM
Customize	Gain Type	Retractive Gain
Maintain	Bubble	OFF
Network	Clock Display	OFF
	Return	



Operation guide

Guide	
ENT	:Enter
▲▼	:Select
◀	:Return
▶	:Enter
SUBMENU	:Return
MENU	:End

Function guide

Func. Guide Window  
 This is to select function of the [EVENT]key, from "Store Position", "Store Image" or "Homing". "Homing" is the navigation function to return to the fish point quickly.

The operation guide is displayed when [SUBMENU], [System] and [Guide Window] are all on. (See the Instruction Manual [Advanced] "5.2.1 Display/No display of Guide Window")  
 The function guide is displayed when [SUBMENU], [System] and [Func. Guide Window] are all on. (See the Instruction Manual [Advanced] "5.2.2 Display/No display of Func. Guide Window")

To close the Submenu, press [SUBMENU] key  or [MENU] key .

[SUBMENU], [Guide Window] and [Func. Guide Window] disappear.

**1.8.4 Operation of SUBMENU**

Press [▲] key or [▼] key of  to select a menu item during SUBMENU is displayed.

List of the setting items changes to the corresponding contents with the selected Submenu item.

Menu column	Setting item column	Setting value column
<b>System</b>	Event Key Usage	Store Image
Source	FUNC1.Key Setting	Image Title
NMEA 1	FUNC2.Key Setting	IR
NMEA 2	Guide Window	ON
Correct	Func. Guide Window	ON
Heaving	Header Display	ON
TD Setting	Simple Menu	OFF
Basics	CM Key Usage	CM
Customize	Gain Type	Retractive Gain
Maintain	Bubble	OFF
Network	Clock Display	OFF
	Return	

Press [▶] key of .

Cursor appears in the setting item column.



Menu column	Setting item column	Setting value column
System	<b>Event Key Usage</b>	Store Image
Source	FUNC1.Key Setting	Image Title
NMEA 1	FUNC2.Key Setting	IR
NMEA 2	Guide Window	ON
Correct	Func. Guide Window	ON
Heaving	Header Display	ON
TD Setting	Simple Menu	OFF
Basics	CM Key Usage	CM
Customize	Gain Type	Retractive Gain
Maintain	Bubble	OFF
Network	Clock Display	OFF
	Return	

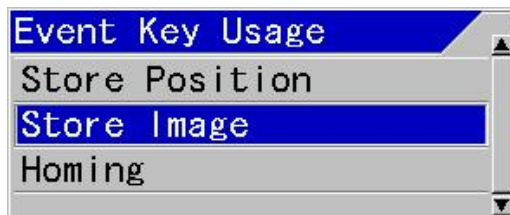

Press [▲] key or [▼] key of  to select the item to change.

Then, press [▶] key of , and the setting box appears with the corresponding selection items.





Press [▲] key or [▼] key of  to change the setting.

To return the cursor to the set item column, press [◀] key of  or [SUBMENU] key of . Then, the cursor returns to the set item column.

To return to the menu column, press [◀] key of  or [SUBMENU] key of . Then, the cursor returns to the menu column.

To close the menu, press [SUBMENU] key  or [MENU] key .

 **Caution:** When [MENU] key  is pressed during operation of the Submenu, the display of the Submenu will disappear.

**1.9 To read echo sounder's screen**

A screen of echo sounder consists of the header display in a gray color stripe at upper portion and the image display part of the echo sounder.





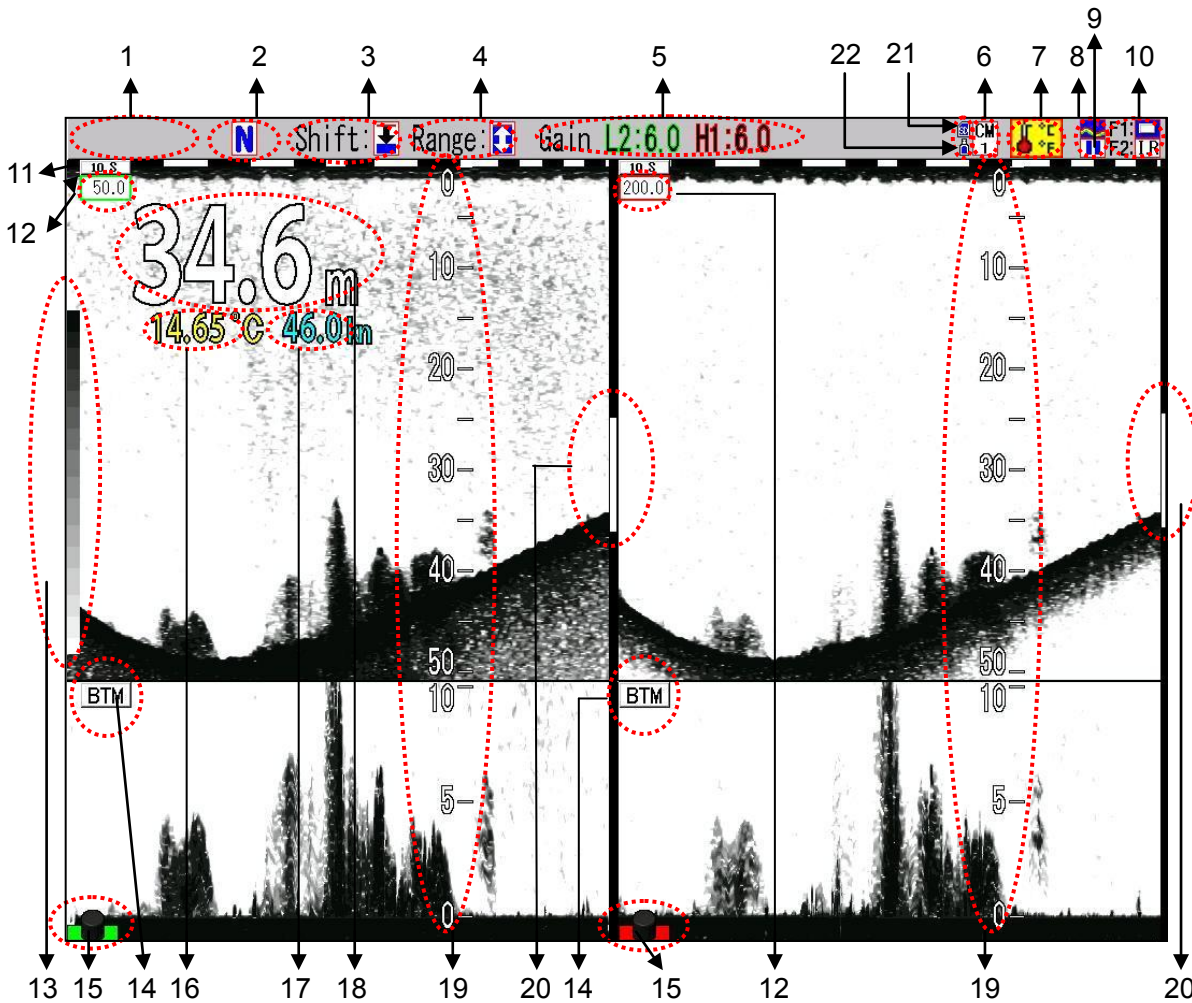

































The header display indicates setting status of various functions by icons for easier understanding.

The echo sounder image display part overlays the necessary information for fish school finding.





























**Header display**

No.	Name	Description
1	Range Mode	[Auto Range] for Auto Range No display for Manual [Auto Shift] for Auto Shift
2	[SHIFT] and [RANGE] status icon	Shift/Range on normal screen Shift on partial zoom/Range zoom screen
3	Shift mode icon	Shift:  All screens same Shift:  Scr. Individual Shift off
4	Range mode icon	All screens same Scr. Individual

5	Gain (TD)	L2: Gain value of low frequency 2 L1: Gain value of low frequency 1 H2: Gain value of high frequency 2 H1: Gain value of high frequency 1
6	CM icons	 CM1 on display  CM2 on display  CM3 on display  CM4 on display  CM5 on display  CM6 on display
7	Alarm setting status	 : Bottom Alarm ON  : Fish Alarm ON  : Speed Alarm ON  : Arrival Alarm ON  : XTE Alarm ON  : Water Temp Alarm ON No display: No Alarm activated
8	[EVENT] key status (indicates the settings)	 : Position storage and TLL output  : Image storage  : Start Homing
9	Image scroll speed	 : High speed  : Stop  : Normal (1/1)  : Low speed
10	F1]/[F2] key status icon (indicates the settings)	 : Shift Digit Input  : IR (Interference rejection)  : Color Erase  : Noise Reduction  : Background color  : TVG Adjust  : White Line  : A Scope  : Image Swap  : Image Title  : VRM Interval  : Nav Start  : Image Recall  : Frequency  : Event Key Usage  : Key Lock  : Depth Unit  : Color Tone  : B.D. Mode

## Display portion of echo sounder images

No.	Name	Description
11	Time marker	 indicates the image scroll speed. White/Black and Green/Black switch at every 5 minutes.  : White/Black indicates 10 seconds.  : Green/Black indicates 10 seconds.  : White/Black indicates 1 minute.  : Green/Black indicates 1 minute.
12	Image title	 : High frequency 1  : High frequency 2  : Low frequency 1  : Low frequency 2  : Mix A  : Mix B  : Mix C  : Mix D  : Fish school size Numerical value: Frequency
13	Color Bar Scale	Scale for color representation of images by echo sounder
14	Zoom image title	 : Sea bottom-fixed zoom  : Sea bottom discrimination zoom  : Zoom  : Bottom follow zoom  : Bottom follow zoom with high frequency 1  : Bottom follow zoom with high frequency 2  : Bottom follow zoom with low frequency 1  : Bottom follow zoom with low frequency 2
15	Gain knob icon	 : Individual gain, individual range, individual shift and VRM operation are available.  : Individual gain operation is available  : Individual range, shift and VRM operation are available. None : Operation unavailable
16	Water temperature	Value of water temperature ( °C or °F)
17	Vessel speed	Vale of vessel speed (kn, km/h or mph)
18	Water depth	Depth of sea bottom (m, J.fm, fm, l.fm, ft)
19	Scale	Depth scale of normal images and zoom images
20	Zoom range bar	Bar to indicate the display range of zoom images against normal images
	Alarm range bar	Bar to indicate the alarm range against normal images
21	SD card icon	 : SD card connected None : SD card not connected
22	USB memory icon	 : USB memory connected None : USB memory not connected



## 1.10 Adjustment of brilliance for comfortable viewing

### 1.10.1 Adjustment of panel brilliance

The brilliance of display panel can be adjusted at [Panel Brill]

When [BRILL  $\odot$ ] key is pressed, the [Panel Brill] box is displayed.



When [ $\blacktriangle$ ] key of  is pressed, the panel brilliance turns brighter and when [ $\blacktriangledown$ ] key is pressed, the panel brilliance will turn darker.

1 is for the darkest and 10 is for the brightest.

To close the menu, press [MENU] key .

For finer adjustment at 1 to 10 individually, point the cursor to the desired number of [Brill Set] by [ $\blacktriangle$ ] or [ $\blacktriangledown$ ] keys of  while the [Panel Brill] box is on display.

Press [ENT] key , and the box for [Brill Set] appears.

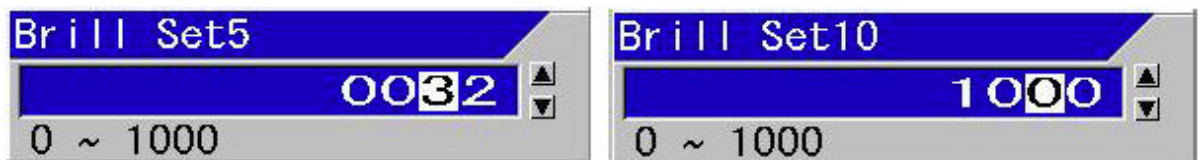

Point the cursor to the digit to be changed with [ $\blacktriangleleft$ ] or [ $\blacktriangleright$ ] keys of  and:

The numeric value increases with [ $\blacktriangle$ ] key.

The numeric value decreases with [ $\blacktriangledown$ ] key.

Press [ENT] key , and the value is set and returns to the [Panel Brill] box.

To close the menu after setup of the value, press [MENU] key .



## Chapter 2 Basic operation

### 2.1 Switch screen images (Setting up of CM menu)

At setup of CM\*1 Menu, images on screen can be switched over.

If the setup of CM Menu is registered in [CM] keys, there is no need to operate CM Menu at every time of change of images. As for the details of [CM keys and the storing method into the [CM] keys, please see “Chapter 3 To make the best of [CM] keys”, p 3 - 1.



The main setup items in this chapter at this point are as follows:

- Display of normal images
- Change of frequency
- Display of zoom images
- Display of mixed images
- Selection of pulse length
- Selection of frequency bandwidth
- Selection of changing method of gain

#### 2.1.1 Display of 1-frequency/displays of 2-frequency and more

JFC-180BB can switch ON/OFF the display of 4-frequency images individually.

To select Standard Echo Display:

1. Press [CM] key used ([CM] key lit red)  
When CM1 is lit red, press [CM1] key  .
2. CM Menu is displayed.
3. Moving the cursor with  key, select [Normal] or [OFF] of high frequency 1 in Standard Echo Display items.







Standard Echo Display items

CM1	Low Frequency2	Low Frequency1	High Frequency2	High Frequency1
Standard Echo Display	▶Normal	▶Normal	▶Normal	▶Normal
	OFF	Mix	Mix	OFF
Frequency	38.0KHZ	75.0KHZ	130.0KHZ	200.0KHZ
Pulse Length	Short	Short	Short	Short
	▶Medium	▶Medium	▶Medium	▶Medium
	Long	Long	Long	Long
	Fixed	Fixed	Fixed	Fixed
Band Width	Narrow	Narrow	Narrow	Narrow
	▶Medium	▶Medium	▶Medium	▶Medium
	Wide	Wide	Wide	Wide
Zoom Display	Fixed	Fixed	Fixed	Fixed
	▶OFF	▶OFF	▶OFF	▶OFF
	Bottom	Bottom	Bottom	Bottom
	B.D.	B.D.	B.D.	B.D.
	Zoom	Zoom	Zoom	Zoom
Gain	B.Z.	B.Z.	B.Z.	B.Z.
	B.F.Z.	B.F.Z.	B.F.Z.	B.F.Z.
	▶Individual	Synchronized		
Guide	ENT :Enter			38.0
	▲▼◀▶ :Cursor	SUBMENU:Return	75.0	130.0
		MENU :End	200.0	



When [Normal] is selected, normal images are displayed on high frequency 1 screen.  
When [OFF] is selected, high frequency 1 screen is not displayed.

\*1 CM (Condition Memory) : CM is the key to store the setting conditions of the echo sounder and to recall them by one touch. There are 6 keys, CM1 to CM6, to store 6 types of setups.

4. Press [ENT] key  .
5. Moving the cursor with  , select [Normal], [Mix] or [OFF] in the Standard Echo Display items of high frequency 2, and press [ENT] key  .  
When [Normal] is selected, normal images are displayed on high frequency 2 screen.  
When [Mix] is selected, mixed images are displayed on high frequency 2 screen. (As for details, please see “2.1.4 Display of mixed images”, p 2-15)  
When [OFF] is selected, no high frequency 2 screen is not displayed.
6. Moving the cursor with  , select [Normal], [Mix] or [OFF] in the Standard Echo Display items of low frequency 1 and press [ENT]  key.  
When [Normal] is selected, normal images are displayed on low frequency 1 screen.  
When [Mix] is selected, mixed images are displayed on low frequency 1 screen. (As for details, please see “2.1.4 Display of mixed images”, p 2-15)  
When [OFF] is selected, no low frequency 1 screen is not displayed.
7. Moving the cursor with  , select [Normal], or [OFF] in the Standard Echo Display items of low frequency 2 and press [ENT] key  .  
When [Normal] is selected, normal images are displayed on low frequency 2 screen.  
When [OFF] is selected, no low frequency 2 screen is not displayed.

**2.1.2 Setting frequency to match the transducer to be used**

On JFC-180BB, the frequencies used for 4 screens can be set in a range of 24 to 240 kHz. The range of selectable frequency depends on the transducers connected.

**At the time of the initial usage**



In the case the other transducer than TDM-052A is used with JFC-180BB for the first time after purchase, it is necessary to adjust setting of the transducer.

Factory default setting of JFC-180BB is as follows: the type of transducer is TDM-052A, high frequency 1 is 200 kHz, high frequency 2 is 130 kHz, low frequency 1 is 75 kHz and low frequency 2 is 38 kHz.

If the connected transducer is different from the factory default, the setting shall be performed at first.

As for the setting of transducer, please see the Installation Manual “2.1 Setup of transducer” of “Chapter 2 Adjustment”.

**To change frequency:**

1. Press [CM] key used (lights red).  
When CM1 is lit red, press [CM1] key  .
2. CM menu will be displayed.
3. Move the cursor to the position that indicates the frequency of high frequency 1 in frequency display items using  .

Frequency display items

CM1	Low Frequency2	Low Frequency1	High Frequency2	High Frequency1
Standard	▶Normal	▶Normal	▶Normal	▶Normal
Echo Display	Mix	Mix	Mix	Mix
	OFF	OFF	OFF	OFF
Frequency	38.0kHz	75.0kHz	130.0kHz	200.0kHz
Pulse Length	▶Short	▶Short	▶Short	▶Short
	▶Medium	▶Medium	▶Medium	▶Medium
	Long	Long	Long	Long
	Fixed	Fixed	Fixed	Fixed
Band Width	Narrow	Narrow	Narrow	Narrow
	▶Medium	▶Medium	▶Medium	▶Medium
	Wide	Wide	Wide	Wide
	Fixed	Fixed	Fixed	Fixed
Zoom Display	▶OFF	▶OFF	▶OFF	▶OFF
	Bottom	Bottom	Bottom	Bottom
	B.D.	B.D.	B.D.	B.D.
	Zoom	Zoom	Zoom	Zoom
	B.Z.	B.Z.	B.Z.	B.Z.
	B.F.Z.	B.F.Z.	B.F.Z.	B.F.Z.
Gain	▶Individual			
	Synchronized			
Guide	ENT :Enter			SUBMENU:Return
	▲▼◀▶:Cursor			MENU :End
				

4. Press [ENT] key  .
5. [Frequency] box is displayed.

6. Increase or decrease the value with [▲] and [▼] key of  to set frequency.

[▲] key: The numeric value increases.

[▼] key: The numeric value decreases.

When the key is kept pressed, the value automatically shifts to the upper digit.

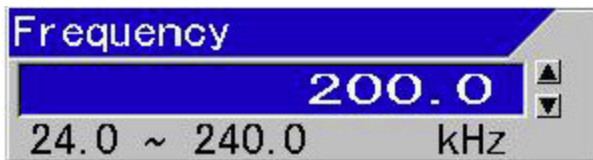

7. Press [ENT] key .
8. Repeat the procedures 3 to 7 for frequencies on other screens.



**Caution:** When the other transducer than broadband type (TDM-052A, TDM-062A) is connected, the transducer cannot perform the designated specification if frequency setting exceeds the fixed range of the transducer.

**Setting up of frequency:**

1. Relation between a transceiver and display screen  
For JFC-180BB, there are two types of transceiver for high frequency and low frequency, and each transceiver has two channels of channel 1 and channel 2.  
High frequency 1 is the channel 1 for high frequency.  
High frequency 2 is the channel 2 for high frequency.  
Low frequency 1 is the channel 1 for low frequency.  
Low frequency 2 is the channel 2 for low frequency.
2. Limitation in setting of high and low frequencies:  
In the case of a broadband transducer, the cable at high frequency side of the transducer shall be connected to the high frequency terminal and the cable at low frequency side of transducer shall be connected to low frequency terminal.  
The frequency range to be set has the following limitations per transducer.

Name of transducer	Frequency range of low frequency	Frequency range of high frequency
TDM-052A	38 to 75 kHz	130 to 210 kHz
TDM-062A	38 to 75 kHz	85 to 135 kHz

 **Caution:** If the frequency setting exceeds the ranges above, gain will not be enough to let the transducer perform to the designated specification.

When the other transducer than broadband type is connected, please connect the cable for low frequency of the transducer to the low frequency terminal and the cable for high frequency of the transducer to the high frequency terminal, and set the designated frequency of the transducer.

3. Simultaneous transmission and reception\*<sup>1</sup> and alternate transmission and reception\*<sup>2</sup>  
Two transceivers for high frequency and low frequency transmit and receive simultaneously, and the channel 1 and channel 2 of each transceiver operate in alternate transmission and reception.
4. When the same frequency is set for high frequencies 1 and 2 or low frequencies 1 and 2, alternate transmission and reception do not operate. Transmission and reception are performed by only channel 1 and the image is displayed using the channel 1 data by the channel 2 gain setting.
5. The conditions when alternate transmission and reception can operate even when the same frequency is set for channels 1 and 2:
  - If pulse width is different
  - If frequency bandwidth is different
  - If range is different.
  - If shift is different.
  - If the types of display zoom is different.

\*1 Simultaneous transmission and reception: Each transmitter and receiver for high frequency and low frequency operates simultaneously.

\*2 Alternate transmission and reception: Channels 1 and 2 of high frequency and channels 1 and 2 of low frequency transmit and receive alternately by each channel. The image scroll speed will drop to a half of that of simultaneous transmission and reception

### 2.1.3 Displaying of zoom images

To display zoom images:

1. Press the [CM] key used (Lights red [CM] key).



When CM1 is lit red, press the [CM1] key  .

2. The CM menu is displayed.

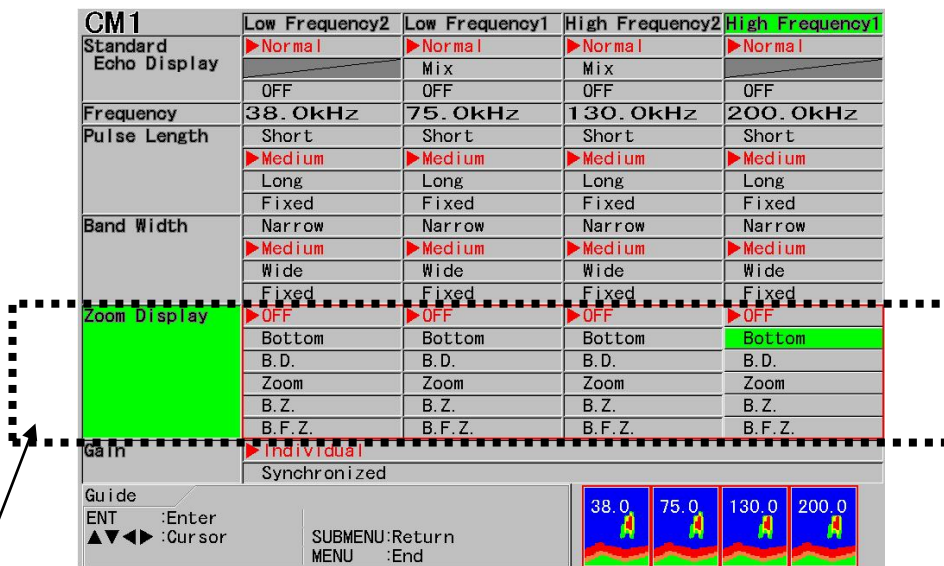
3. Moving the cursor with  , select [OFF], [Bottom], [B.D.(Bottom Discrimination)], [Zoom], [B.Z. (Bottom Zoom)] and [B.F.Z. (Bottom Follow Zoom)] for high frequency 1 of Zoom Display items.



Zoom Display items

4. Press [ENT] key  .
5. Repeat the procedures 3 and 4 for zoomed display of high frequency 2, low frequency 1 and low frequency 2.
6. Press [CM1] key  to close the CM menu ([CM] key lit red).

#### Configuration of zoomed image display :

The zoom image is displayed with normal image on the upper side of the screen and the zoom image at the bottom side of the screen, except for the case of [B.Z.].

When one or two normal images are selected to be displayed, zoom images can be displayed next to the normal image.

(See the Instruction Manual [Advanced] “1.9.12 Zoom image Split”)

[Zoom range bar] is shown in orange on the side of the latest normal image, to indicate the range of zoom image.

The screen width of zoom range can be changed by [MENU]. (for the details, see “To change the screen Width of Zoom Image”, p 2 - 13)



**Types of zoomed images**

1. Bottom

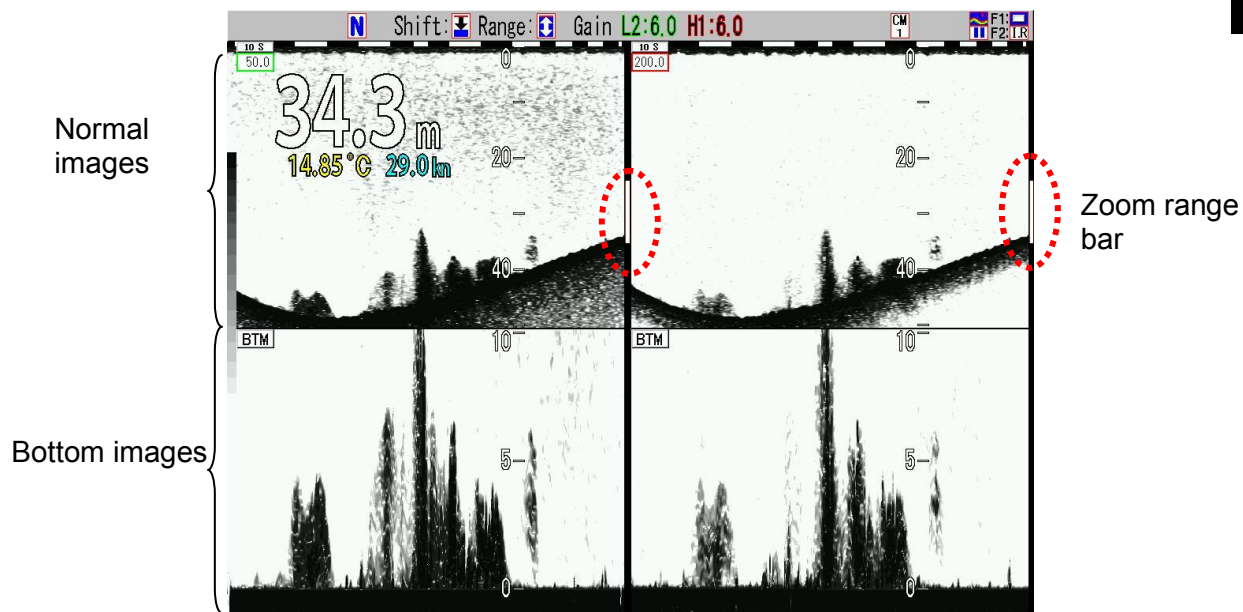

Sea bottom is fixed at 10% bottom of the screen, and the image above is displayed in the specified zoom range. As the image on sea bottom is magnified, this is an effective zooming mode to identify fish schools, etc. near the bottom.

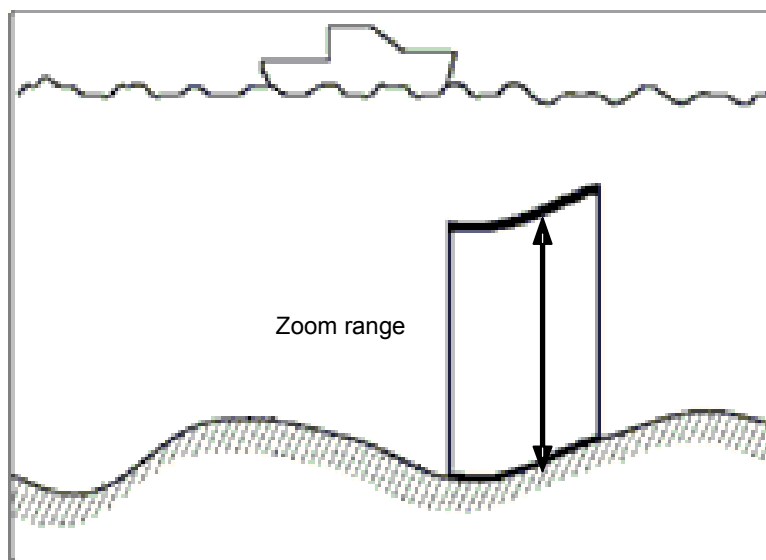

2. Bottom discrimination

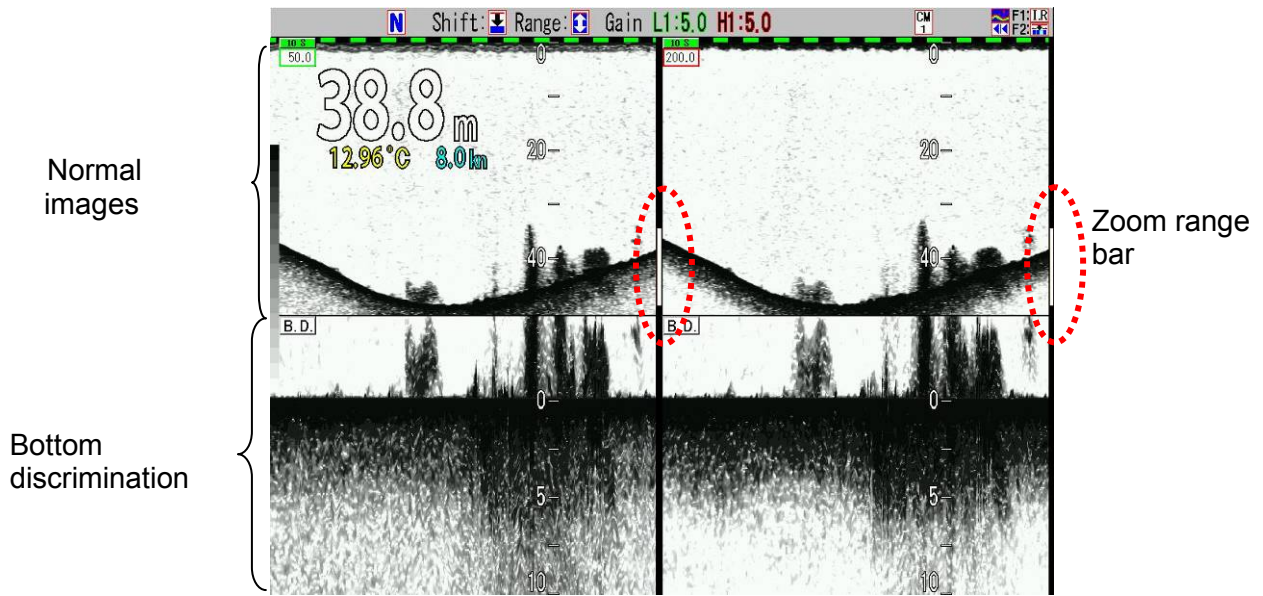

Sea bottom is fixed at 30% bottom of the screen, and the image of bottom is displayed in the specified zoom range.

As the sea bottom image is magnified, this is an effective zoom mode to judge the sea bottom condition.

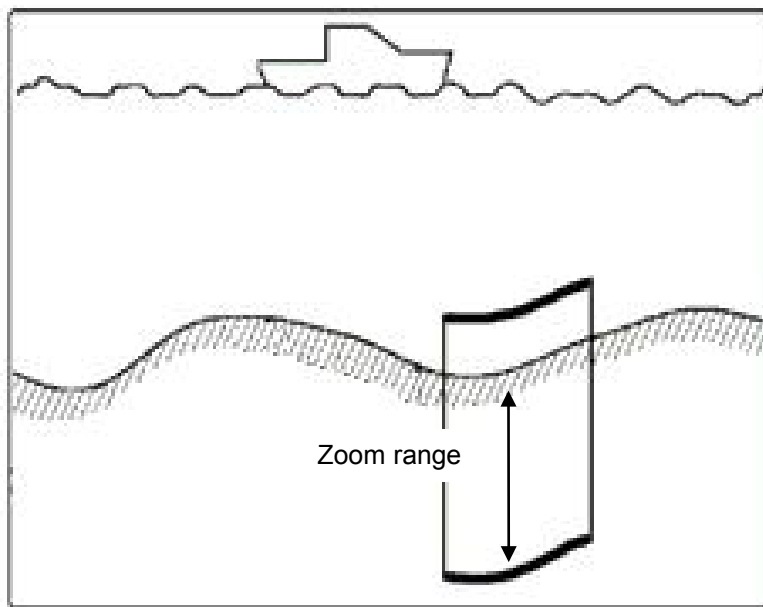

3. Zoom

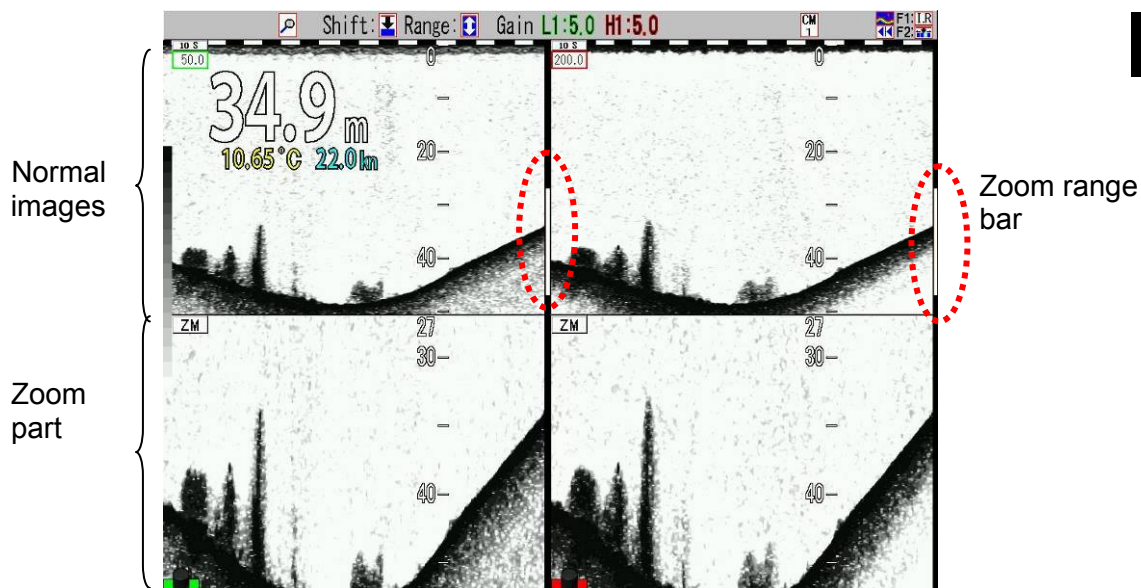

Specifying a shift position, the images under the position is displayed in the specified zoom range.

As the zoomed image at the specified positions is displayed, this is an effective zooming mode for the case when image at particular depth is required for fishing of alfonsino, etc.

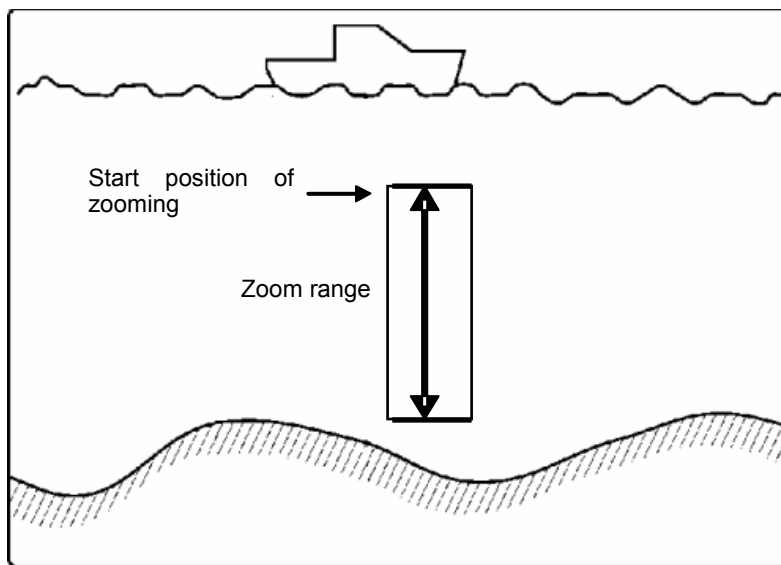

As for operation of shift position of zooming, please see “To change the shift position of Zoom”, p 2 - 12.

4. Bottom zoom

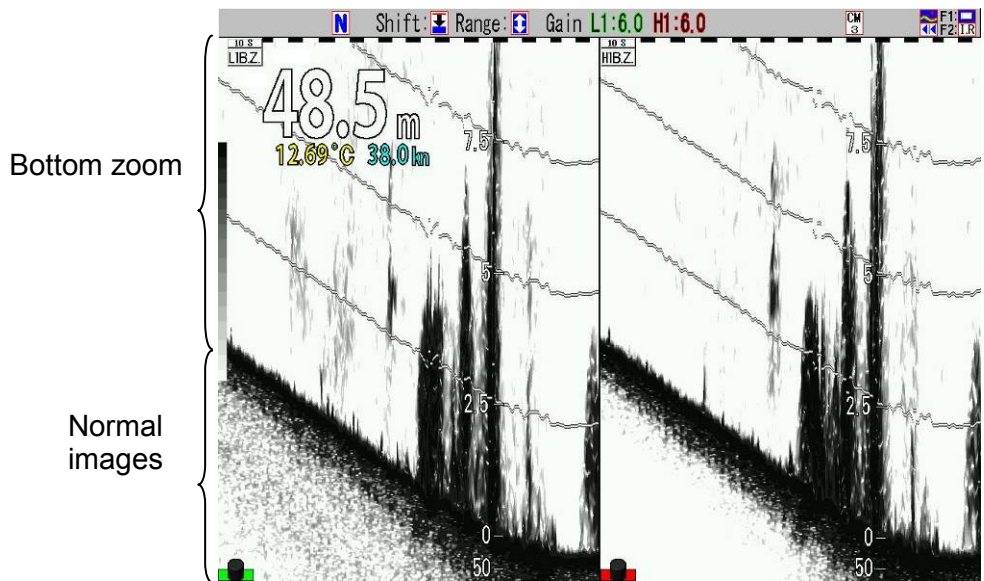

Mixed images above bottom in a specified zoom range are displayed onto the normal image.

This is an effective mode to identify fish schools, etc. near sea bottom with watching the geomorphic changes of sea bottom.

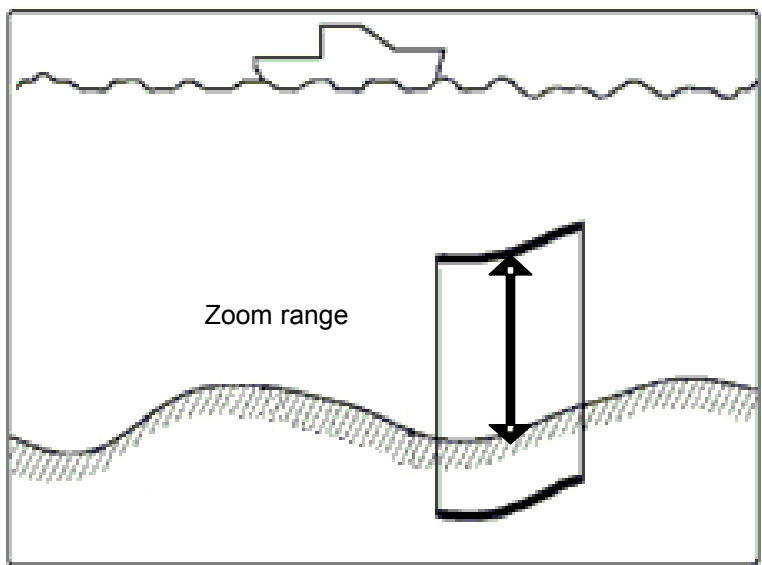

5. Bottom follow zoom

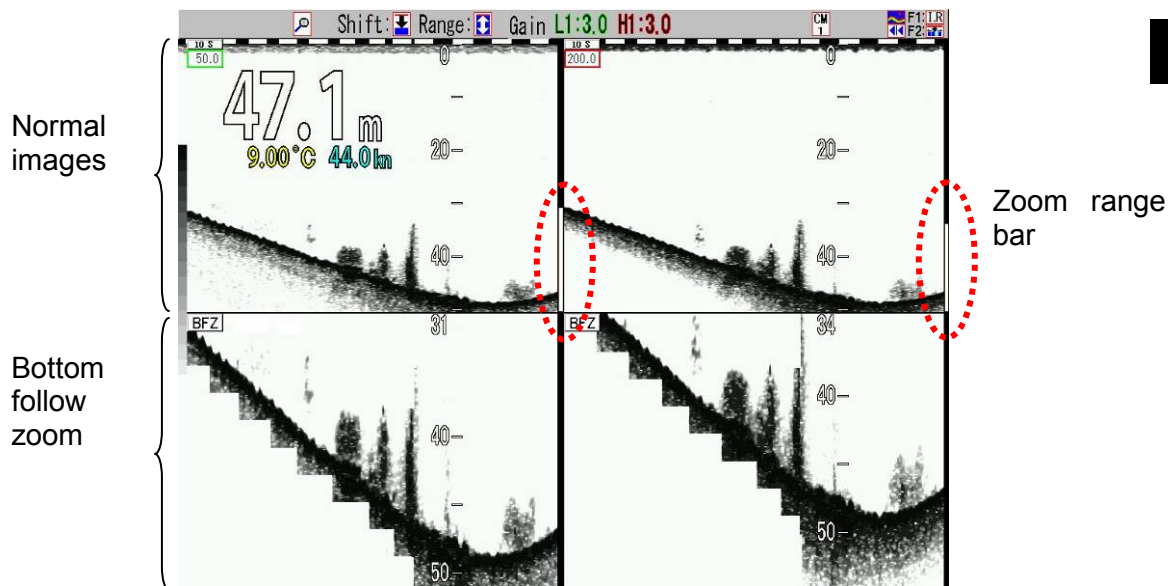

In a specified zoom range, the sea bottom is displayed by automatic shift to be displayed within a range between 30 % and 90 % from the top of images

This is an effective zooming mode to determine the geomorphic changes of sea bottom.

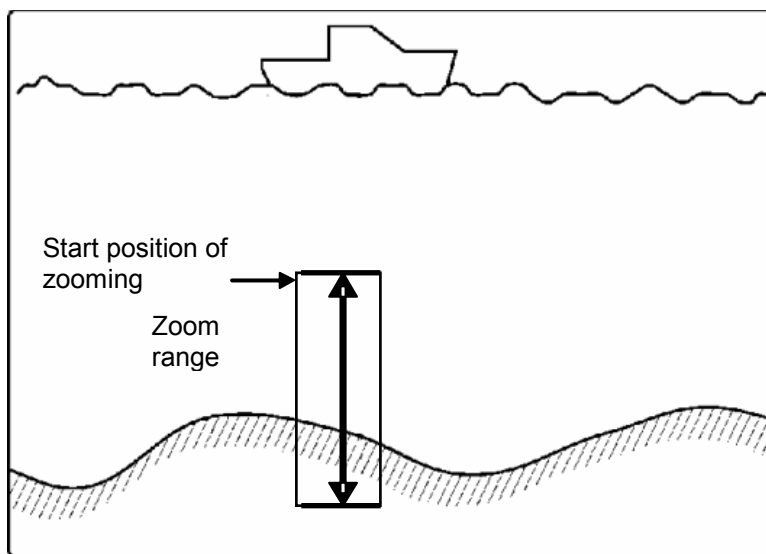





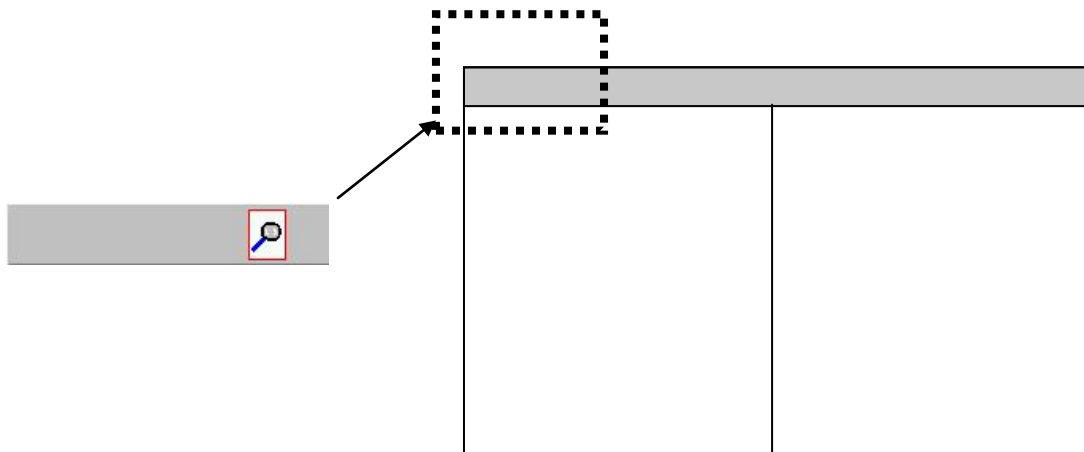

**Caution:** When a range of normal image is set at a shallow and a bottom is deep using Bottom follow zoom mode, the range of Bottom follow zoom is deep and the update speed of the image is slow.

### To change the range of zoomed images







When the icon  to show the mode of [Range] and [Shift] keys is in header display, the range of the zoomed images can be changed.



1. When the icon of header display part is , press [NORMAL/ZOOM] key .
2. Check that the icon of the header display part is  indicating zooming operation.
3. With [] of [RANGE] key , the range is changed to the zoom range in shallow side and with [], the range turns to the zoom range in deep side.

### To change the shift position of Zoom:

When the icon to show the mode of [RANGE] [SHIFT] keys in header display is , the shift of zoomed images can be changed.

1. When the icon of header display is , press [NORMAL/ZOOM] key .
2. Check that the icon of header display is  indication zooming operation.
3. With [] of [SHIFT] key , the zooming position shifts upward and with [] downward.  
If the key is kept pressed, the digit moves upward changing the value.

The shift of zoom can be also changed by operation of [Shift Setup] [Zoom Shift Position] in the main Menu.



**Screen Width of Zoom Image:**

The screen width of zoomed images can be changed to 3 steps of [Wide], [Medium] and [Narrow] depending on preference.

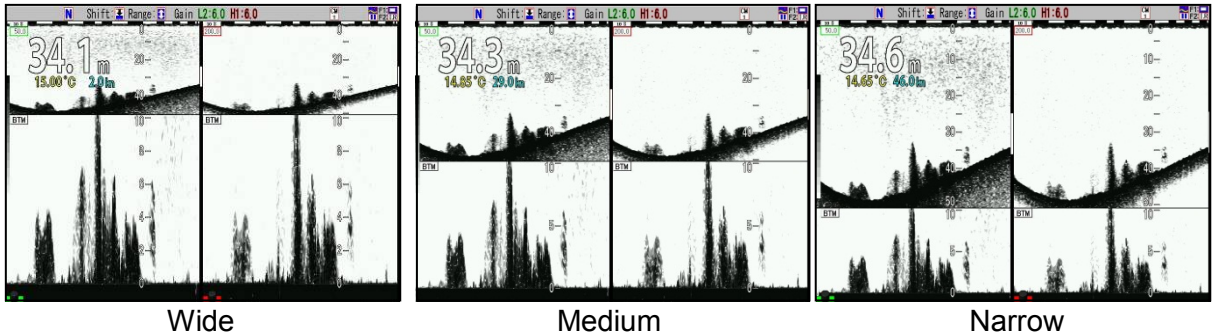
<Examples of Width of Zoom Image (in the case of Bottom)>



**To change the screen Width of Zoom Image:**



1. Press [MENU] key .
2. The menu is displayed. With [▲] or [▼] keys of , point the cursor to [Disp. Setup 1].

Echo Adjust	A Scope	OFF
TVG	White Line	OFF
Disp. Setup1	Mix	A
Disp. Setup2	Image Direction	← ←
Range Setup	Image Swap	A B
Shift Setup	Image Split	Vertical
BTM Search	Width of Zoom Image	Narrow
Alarm1	Zoom Image Split	Standard
Alarm2	Sub Depth Value	OFF
NAV	Return	
Image		
Manual Set		

3. Press [▶] key of .

4. [Disp. Setup 1] of Menu is displayed. With [▲] or [▼] keys of , point the cursor to [Width of Zoom Image].

Echo Adjust	A Scope	OFF
TVG	White Line	OFF
Disp. Setup1	Mix	A
Disp. Setup2	Image Direction	← ←
Range Setup	Image Swap	A B
Shift Setup	Image Split	Vertical
BTM Search	<b>Width of Zoom Image</b>	Narrow
Alarm1	Zoom Image Split	Standard
Alarm2	Sub Depth Value	OFF
NAV	Return	
Image		
Manual Set		

5. Press [▶] key of  .
6. [Width of Zoom Image] is displayed. With [▲] or [▼] keys of , select [Wide], [Medium] or [Narrow]

<b>Width of Zoom Image</b>
Wide
Medium
<b>Narrow</b>

7. When [MENU] key  is pressed, the menu disappears and the selected [Width of Zoom Image] is set.



### 2.1.4 Display of mixed images

Mixed images are combination of high and low frequency images by signal processing. The main purpose is to identify small fish, such as whitebait, from other fish school.

For example, when high frequency is 200 kHz, the wavelength of underwater acoustic wave is 0.75 cm, and when low frequency is 50 kHz, the wavelength of underwater acoustic wave is 3.0 cm. In the image of low frequency 50 kHz, fish smaller than 3 cm is hardly detected.

As school of small fish such as whitebait is clearly displayed in high frequency signal with short wavelength, only school of small size fish is displayed in warm color from red to greenish yellow in fish school mode.

By this, it is easy to identify smaller size than 3.0 cm.

There are 5 types for mixing methods and they are switchable in application.

Types of mixed images:

1. Mix type A

Images in high frequency and low frequency are compared. The red level signal indicates high frequency images. For the signal at lower level than that, the high frequency signal is displayed in gray color.

As fish schools with strong high frequency signal are highlighted, this is helpful for identification of fish schools near own boat's position.

2. Mix type B

Only when high frequency signal is stronger than low frequency signal, the low frequency signal is subtracted from the high frequency signal, and the difference is displayed with color gradation.

The images existing only in high frequency are highlighted.

Small fish such as whitebait can be displayed in high frequency, but not in low frequency.

This is helpful, therefore, for identification of schools of small fish.

3. Mix type C

Images in high frequency and low frequency are compared. The red level signal indicates high frequency images. For the signal at lower level than that, only when the high frequency signal is stronger than the low frequency signal, the low frequency is subtracted from the high frequency and the difference is displayed with color gradation.

Strong signal with high frequency and images only in high frequency are highlighted.

This is helpful, therefore, for identification of fish school near own boat and school of small fish such as whitebait.

4. Mix type D



Signals of images of high and low frequencies are compared, and the stronger signal is displayed with color gradation.

This is completely combined image of high and low frequencies. Without viewing of each of high and low frequencies images, only this one image can tell the conditions in water.

5. Fish size in fish school size

Comparing signals of high and low frequencies, only signal with higher level of high frequency is displayed as difference in the order of strength, from red (strongest) to greenish yellow with color gradation. Low frequency images are indicated in greenish yellow to light blue with color gradation and the mixed image of them is displayed.

**To display mixed images:**

1. Press [CM] key used (Lights red).  
When CM1 is lit red, press it .
2. CM menu is displayed.
3. Moving cursor with , point the cursor to [Mix] of high frequency 2 or Low frequency 1 of Standard Echo Display items.

Standard Echo Display

CM1	Low Frequency2	Low Frequency1	High Frequency2	High Frequency1
Standard Echo Display	▶ Normal	▶ Normal	▶ Mix	▶ Normal
	OFF	OFF	OFF	OFF
Frequency	38.0kHz	75.0kHz	100.0kHz	200.0kHz
Pulse Length	Short	Short	Short	Short
	▶ Medium	▶ Medium	▶ Medium	▶ Medium
	Long	Long	Long	Long
	Fixed	Fixed	Fixed	Fixed
Band Width	Narrow	Narrow	Narrow	Narrow
	▶ Medium	▶ Medium	▶ Medium	▶ Medium
	Wide	Wide	Wide	Wide
	Fixed	Fixed	Fixed	Fixed
Zoom Display	▶ OFF	▶ OFF	▶ OFF	▶ OFF
	Bottom	Bottom	Bottom	Bottom
	B. D.	B. D.	B. D.	B. D.
	Zoom	Zoom	Zoom	Zoom
	B. Z.	B. Z.	B. Z.	B. Z.
	B. F. Z.	B. F. Z.	B. F. Z.	B. F. Z.
Gain	▶ Individual			
	Synchronized			
Guide	ENT :Enter		SUBMENU:Return	
	▲▼▶ :Cursor		MENU :End	

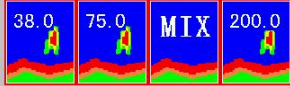



4. Press [ENT] key .

**Caution:** Mixing can be selected only when images at right and left sides of the display screen are displayed. 3 types of mixed image are selectable: high frequency 1 and low frequency 1 mixings, high frequency 1 and low frequency 2 mixings, and high frequency 2 and low frequency 2 mixings can be selected.

**Caution:** Mixed image cannot be displayed when range is set at [Scr. Individual] and shift is set at [Scr. Individual], and when zoom display is at [Zoom], [B. Z.] and [B. F. Z.], mixed image cannot be displayed.

**To change the type of mixed image:**

1. Press [MENU] key .
2. The menu is displayed. Move the cursor to [Disp. Setup1] with [▲] or [▼] keys of .

Echo Adjust	A Scope	OFF
TVG	White Line	OFF
Disp. Setup1	Mix	A
Disp. Setup2	Image Direction	← ←
Range Setup	Image Swap	A B
Shift Setup	Image Split	Vertical
BTM Search	Width of Zoom Image	Narrow
Alarm1	Zoom Image Split	Standard
Alarm2	Sub Depth Value	OFF
NAV	Return	
Image		
Manual Set		

3. Press [▶] key of .

4. [Disp. Setup1] of the menu is displayed. Move the cursor to [Mix] with [▲] and [▼] keys of .

Echo Adjust	A Scope	OFF
TVG	White Line	OFF
Disp. Setup1	Mix	A
Disp. Setup2	Image Direction	← ←
Range Setup	Image Swap	A B
Shift Setup	Image Split	Vertical
BTM Search	Width of Zoom Image	Narrow
Alarm1	Zoom Image Split	Standard
Alarm2	Sub Depth Value	OFF
NAV	Return	
Image		
Manual Set		

5. Press [▶] key of .

6. [Mix] of the menu is displayed. Move the cursor to the desired mix type with [▲] and [▼] keys of  to select.

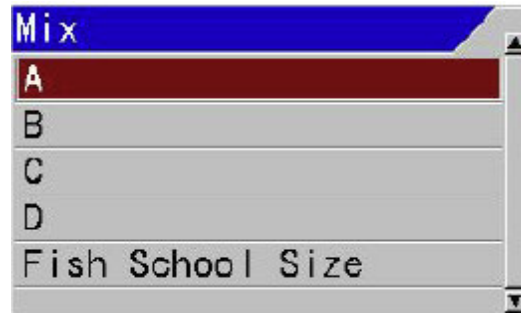

7. Pressing [MENU] key , the menu disappears and the selected mix mode is set.

**2.1.5 Selection of pulse length**

Pulse length can be switched to 4 steps: of Short, Medium, Long and Fixed.

This change of pulse length causes changes in resolution of images from the echo sounder and the signal to be displayed changes. Shorter pulse length increases resolution, but its power decreases. Other way around, longer width decreases resolution but increases power. By this nature, **the pulse length is switched depending on the range**: to Short (narrow) at shallow range and to Long (wide) at deep range, except for the case of setting at [Fixed].



**When pulse length is switched:**

1. For the setup up of pulse length, based on the setup at [Medium] as reference, at [short], the pulse length is switched to the same pulse length as [Medium] pulse length with 1/2 of the range used, and at [Long], to the same pulse length as [Medium] pulse length with 1.5 times of the range used.

When pulse length is set at [Short], small response increases. When pulse length is set at [Long], larger response highlights and small response decreases.

2. When pulse length is set at [Fixed], the width is constant regardless of switching of range. Please set at [Fixed], to avoid change of response from fish by switching of range.



**To select pulse length:**

1. Press [CM] key (lights red) used.  
When CM1 is lit red, press [CM1] key .
2. CM menu is displayed.
3. Moving the cursor with , select [Short], [Medium], [Long] or [Fixed] of high frequency 1 in Pulse Length items.

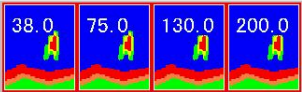

Pulse Length item

CM 1	Low Frequency2	Low Frequency1	High Frequency2	High Frequency1
Standard	▶Normal	▶Normal	▶Normal	▶Normal
Echo Display	OFF	Mix	Mix	OFF
Frequency	38.0kHz	75.0kHz	130.0kHz	200.0kHz
Pulse Length	Short	Short	Short	Short
	▶Medium	▶Medium	▶Medium	▶Medium
	Long	Long	Long	Long
	Fixed	Fixed	Fixed	Fixed
Band Width	Narrow	Narrow	Narrow	Narrow
	▶Medium	▶Medium	▶Medium	▶Medium
	Wide	Wide	Wide	Wide
	Fixed	Fixed	Fixed	Fixed
Zoom Display	▶OFF	▶OFF	▶OFF	▶OFF
	Bottom	Bottom	Bottom	Bottom
	B.D.	B.D.	B.D.	B.D.
	Zoom	Zoom	Zoom	Zoom
	B.Z.	B.Z.	B.Z.	B.Z.
Gain	▶Individual			
	Synchronized			
Guide	ENT :Enter			SUBMENU:Return
	▲▼◀▶ :Cursor			MENU :End





4. Press [ENT] key  .
5. Repeat the procedures 3 and 4 above for pulse length of high frequency 2, low frequency 1 and low frequency 2
6. Press [CM1] key  to close CM menu ([CM] key lit red).

**Setting when [Fixed] for pulse length is selected:**

1. Press [MENU] key  .
2. The menu is displayed. Move the cursor at [Manual Set] with [▲] or [▼] key of  .

Echo Adjust	Pulse Length HF1	Medium
TVG	Bandwidth HF1	3
Disp. Setup1	Pulse Length HF2	Medium
Disp. Setup2	Bandwidth HF2	3
Range Setup	Pulse Length LF1	Medium
Shift Setup	Bandwidth LF1	3
BTM Search	Pulse Length LF2	Medium
Alarm1	Bandwidth LF2	3
Alarm2	Return	
NAV		
Image		
Manual Set		

3. Press [▶] key of  .



4. [Manual Set] of menu is displayed. Move the cursor at [Pulse Length HF1] with [▲] or [▼] keys of .

Echo Adjust	<b>Pulse Length HF1</b>	Medium
TVG	Bandwidth HF1	3
Disp. Setup1	Pulse Length HF2	Medium
Disp. Setup2	Bandwidth HF2	3
Range Setup	Pulse Length LF1	Medium
Shift Setup	Bandwidth LF1	3
BTM Search	Pulse Length LF2	Medium
Alarm1	Bandwidth LF2	3
Alarm2	Return	
NAV		
Image		
Manual Set		

5. Press [▶] of .

6. [Pulse Length HF1] of the menu is displayed. Move the cursor with [▲] or [▼] keys of , and select one of [Short], [Medium] or [Long].

<b>Pulse Length HF1</b>
Short
<b>Medium</b>
Long

7. Press [SUBMENU] key  to return the menu to [Manual Set].
8. To set the fixed value of the pulse length on the next screen, repeat the procedures 4 to 7.
9. Press [MENU] key of , the menu disappears and the selected fixed pulse length is set.



**Caution:** The menu for [Manual Set] is available if [Pulse Length] of CM menu is not set at [Fixed]

#### The pulse length when [Fixed] of pulse length is selected:

1. The pulse length is 210  $\mu$ sec when setting of [MENU], [Manual Set] and [Pulse Length] is [Short].
2. The pulse length is 1000  $\mu$ sec when setting of [MENU], [Manual Set] and [Pulse Length] is [Medium].
3. The pulse length is 3000  $\mu$ sec when setting of [MENU], [Manual Set], and [Pulse Length] is [Long].

**2.1.6 Selection of frequency bandwidth**

Frequency bandwidth can be switched to 4 steps: Narrow, Medium, Wide and Fixed. The change of frequency bandwidth results in change of the resolution of echo sounder and change of signals in the displayed images. If the frequency bandwidth is wide, the resolution becomes high. Other way around, if it is narrow, resolution becomes low.

By this nature, **the frequency bandwidth** is switched depending on the range: to wide at shallow range and to narrow at deep range, except for the case of setting at [Fixed].



**When frequency bandwidth is switched:**

1. For the setup of frequency bandwidth, based on the setup at [Wide] as reference, at [Medium], the bandwidth is switched over to the same bandwidth of [Wide] bandwidth that is 1.5 times of the range used, and at [Narrow], to the minimum bandwidth.

When size of target fish matches the frequency wavelength in use, setup up at [Medium] or [Narrow] highlights the images and increase visibility. When pulse length is set at [Short] and frequency bandwidth at [Narrow], response smaller than wavelength is reduced and noise reduction effect is expected.

2. When frequency bandwidth is setup at [Fixed], the bandwidth is constant regardless of switching of range.

**To select frequency bandwidth:**



1. Press [CM] key (lights red) used.  
When CM1 is lit red, press [CM1] key  .
2. CM menu is displayed.
3. Moving the cursor with  , select [Narrow], [Medium], [Wide] or [Fixed] of high frequency 1 in frequency bandwidth items.

Bandwidth items

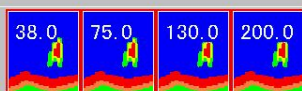

CM1	Low Frequency2	Low Frequency1	High Frequency2	High Frequency1
Standard Echo Display	▶Normal	▶Normal	▶Normal	▶Normal
	Mix	Mix	Mix	Mix
	OFF	OFF	OFF	OFF
Frequency	38.0kHz	75.0kHz	130.0kHz	200.0kHz
Pulse Length	▶Short	▶Short	▶Short	▶Short
	▶Medium	▶Medium	▶Medium	▶Medium
	Long	Long	Long	Long
	Fixed	Fixed	Fixed	Fixed
Band Width	Narrow	Narrow	Narrow	Narrow
	▶Medium	▶Medium	▶Medium	▶Medium
	Wide	Wide	Wide	Wide
	Fixed	Fixed	Fixed	Fixed
Zoom Display	▶OFF	▶OFF	▶OFF	▶OFF
	Bottom	Bottom	Bottom	Bottom
	B.D.	B.D.	B.D.	B.D.
	Zoom	Zoom	Zoom	Zoom
	B.Z.	B.Z.	B.Z.	B.Z.
	B.F.Z.	B.F.Z.	B.F.Z.	B.F.Z.
Gain	▶Individual			
	Synchronized			
Guide	ENT :Enter			
	▲▼◀▶ :Cursor			
	SUBMENU:Return		MENU :End	







4. Press [ENT] key  .
5. Repeat the procedures 3 and 4 for frequency bandwidth of high frequency 2, low frequency 1 and low frequency 2
6. Press [CM1] key  to close CM menu ([CM] key lights red).

**Adjustment when the time of selection of [Fixed] of frequency bandwidth is set [Fixed]:**

1. Press [MENU] key  .
2. The menu is displayed. Move the cursor at [Manual Set] with [▲] or [▼] keys of  .

Echo Adjust	Pulse Length HF1	Medium
TVG	Bandwidth HF1	3
Disp. Setup1	Pulse Length HF2	Medium
Disp. Setup2	Bandwidth HF2	3
Range Setup	Pulse Length LF1	Medium
Shift Setup	Bandwidth LF1	3
BTM Search	Pulse Length LF2	Medium
Alarm1	Bandwidth LF2	3
Alarm2	Return	
NAV		
Image		
Manual Set		

3. Press [▶] key of  .



4. [Manual Set] of the menu is displayed. Move the cursor to [Bandwidth HF 1] with [▲] or [▼] keys of .

Echo Adjust	Pulse Length HF1	Medium
TVG	<b>Bandwidth HF1</b>	3
Disp. Setup1	Pulse Length HF2	Medium
Disp. Setup2	Bandwidth HF2	3
Range Setup	Pulse Length LF1	Medium
Shift Setup	Bandwidth LF1	3
BTM Search	Pulse Length LF2	Medium
Alarm1	Bandwidth LF2	3
Alarm2	Return	
NAV		
Image		
Manual Set		

5. Press [▶] of .

6. [Bandwidth HF 1] of menu is displayed, Move the cursor with [▲] or [▼] keys of , and select [Narrow], [1], [2], [3], [4] or [Wide].

<b>Bandwidth HF1</b>
Narrow
1
2
<b>3</b>
4
Wide

7. Press [SUBMENU] key of  to return to [Manual Set].
8. Repeat the procedures 4 to 7 for setup of fixed bandwidth on the next screen.
9. Press [MENU] key of , and the menu disappears and the selected fixed bandwidth is set.



**Caution:** The menu for [Manual Set] will not be available unless [Bandwidth] of CM menu is set at [Fixed]

**2.1.7 Selection of gain adjustment method**

JFC-180BB can display images up to 4 frequencies and gain can be adjusted for each images. Adjustment of gain is individually done with two gain knobs after selecting of a screen to adjust.

In addition, after having gain optimized individually for each screen, it is also possible to adjust gain of all screens with operation of only one gain knob. This is **synchronized gain**.

In the synchronized gain, the whole gain varies while keeping the difference in gain of each screen.

**To select the changing method of gain:**

1. Press [CM] key used ([CM] key lights red).

When CM1 is lit red, press [CM1] key .

2. CM menu is displayed.

3. Move the cursor with  and select [Individual] [Synchronized] of [High Frequency 1] in gain items.

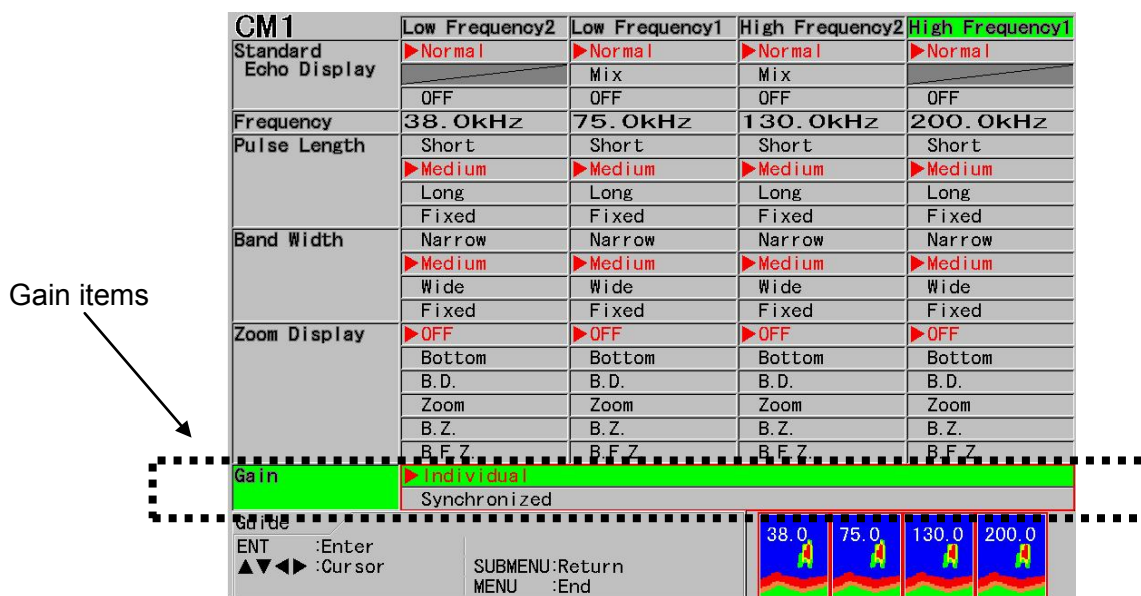

CM1	Low Frequency2	Low Frequency1	High Frequency2	High Frequency1
Standard Echo Display	▶Normal	▶Normal	▶Normal	▶Normal
	OFF	Mix	Mix	OFF
Frequency	38.0kHz	75.0kHz	130.0kHz	200.0kHz
Pulse Length	Short	Short	Short	Short
	▶Medium	▶Medium	▶Medium	▶Medium
	Long	Long	Long	Long
	Fixed	Fixed	Fixed	Fixed
Band Width	Narrow	Narrow	Narrow	Narrow
	▶Medium	▶Medium	▶Medium	▶Medium
	Wide	Wide	Wide	Wide
	Fixed	Fixed	Fixed	Fixed
Zoom Display	▶OFF	▶OFF	▶OFF	▶OFF
	Bottom	Bottom	Bottom	Bottom
	B.D.	B.D.	B.D.	B.D.
	Zoom	Zoom	Zoom	Zoom
	B.Z.	B.Z.	B.Z.	B.Z.
	B.F.Z	B.F.Z	B.F.Z	B.F.Z
Gain	▶Individual			
	Synchronized			

Gain items

ENT :Enter  
 ▲▼◀▶ :Cursor  
 SUBMENU:Return  
 MENU :End

38.0 75.0 130.0 200.0

4. Press [ENT] key .

5. Press [CM1] key  to close CM menu ([CM] key lit red).

As for the details of gain operation, see “2.2.5 Adjustment of image gain”, p 2 - 46.

## 2.2 Adjustment of echo sounder

To use echo sounder, it is necessary to adjust depth range (Range) and gain depending on the circumstances.

The main adjustment items are as follows:

- Switching Range mode
- Switching the role of range key to change of normal image range or zoom image range
- Manual change of range
- Manual change of shift position
- Adjustment of image gain
- Setup of TVG

### 2.2.1 Switching of depth range mode



There are 3 types of Range Mode: [Auto Range], [Manual] and [Auto Shift].

[Auto Range] is the mode to automatically switch depth range so as to display sea bottom constantly in a display screen.

[Manual] is the mode to manually switch depth range with range key operation, and shift with shift key operation.

[Auto Shift] is the mode to automatically shift the preset depth range so as to display constantly sea bottom in a display screen.

#### To switch [Range Mode]:

1. Keep [SHIFT/M OFF] key  pressed until [Range Mode] menu is displayed.
2. Move the cursor with [▲] or [▼] keys of  and select one of [Auto Range], [Manual] or [Auto Shift]

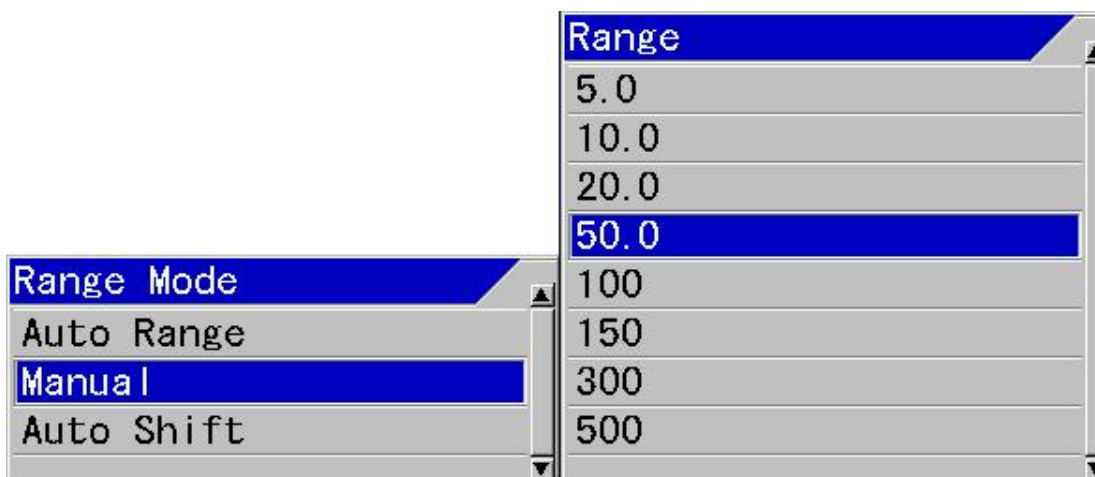

3. Press [ENT] key . The selected Range mode is set.

When [Auto Range] is set, [Auto Range] is displayed in the header showing Range Mode.

When [Manual] is set, display of the header showing the Range Mode disappears.

When [Auto Shift] is set, [Auto Shift] is displayed in the header showing Range Mode.

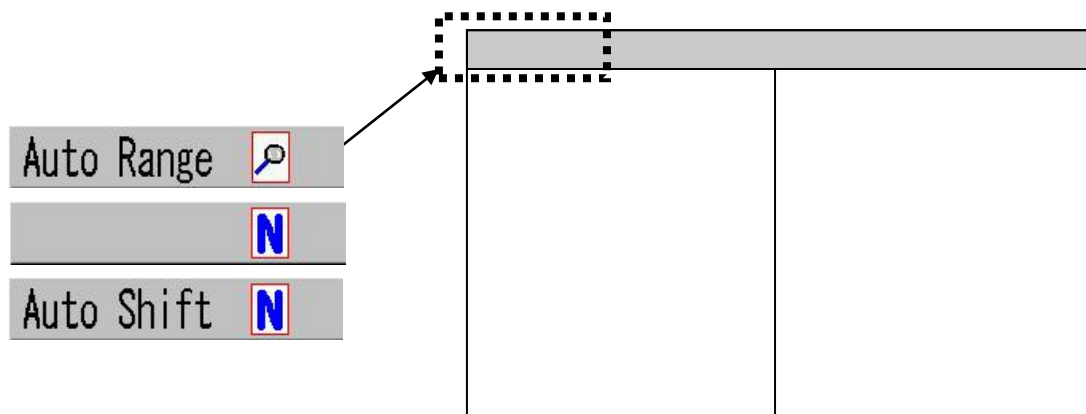

As for the details of [Auto Range], see “4.3.2 Setting of auto range”, p 4 - 4.

As for the details of [Manual], see “2.2.3 Manual change of a range for normal image”, p 2 - 29.

As for the details of [Auto Shift], see “4.3.3 Setting of auto shift”, p 4 - 6

### 2.2.2 Switching of Normal/Zoom for range and shift operation

The range key has two functions of “to change range of normal image” and “to change range of zoomed image”, and the shift key has two functions of “to change shift of normal image” and “to change shift of zoomed image”, respectively.

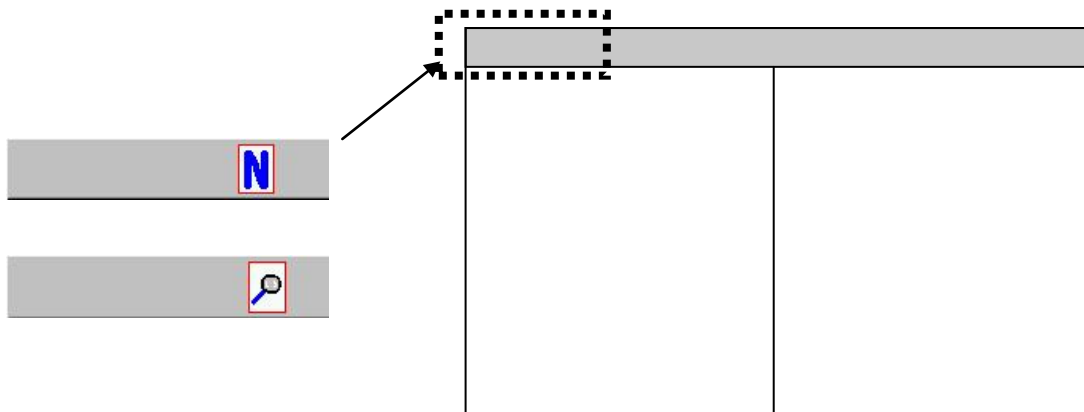

**When Range mode is [Manual] or [Auto Shift] and zoomed image is displayed:**

1. Press [NORMAL/ZOOM] key . Each time the key is pressed, the icon in the header showing range key changes as follows:





2. When  is shown, the range and shift of the normal image can be changed.

When  is shown, the range of zoomed image and shift of zoomed image can be changed.

 **Caution:**  is displayed only when a zoomed image is displayed.



**When Range mode is [Auto Range]:**

1. [Range] key  can be used only for the change of range of zoomed images.

[Shift] key  can be used only for change of shift of zoom.

Auto Range 

Display of header

 **Caution:** When Range mode is [Auto Range], icon  is always displayed. When the zoom screen is not on display, the key operation is invalid.



**2.2.3 Manual change of a range for normal image**

When Range mode is Manual, the range can be changed manually.

In manual range, each time range key is pressed range changes among the 8 ranges registered.

In addition, at manual range, either all range of images of 4 frequencies can be changed with [All Screens Same], or with [Scr. Individual] by image of each frequency.

**To set up Range mode to [Manual]:**

1. Keep [Shift/M OFF] key  pressed until [Range Mode] menu is displayed.
2. Move the cursor with [▲] or [▼] keys of , and select [Manual].

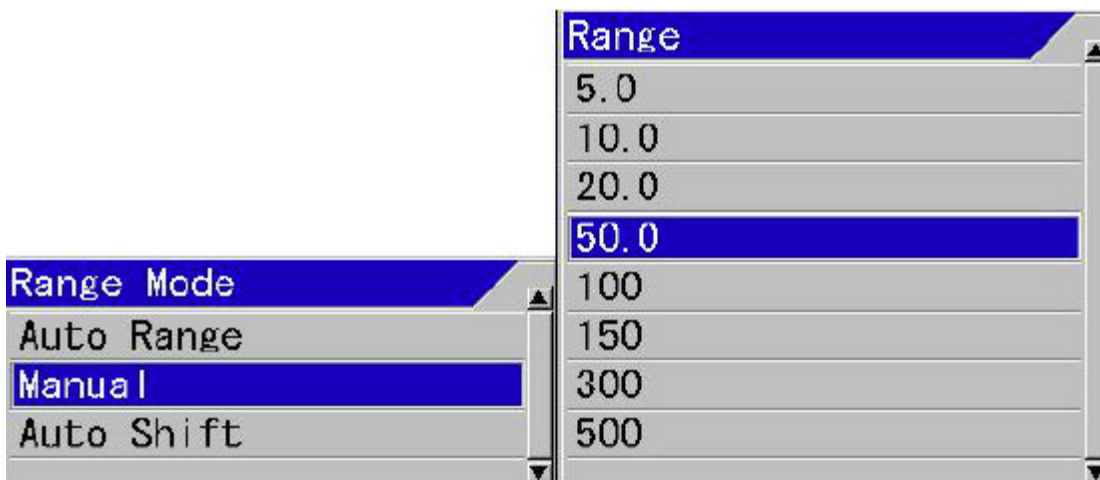

3. Press [ENT] key . Then, [Manual] is set and the header showing the Range Mode disappears

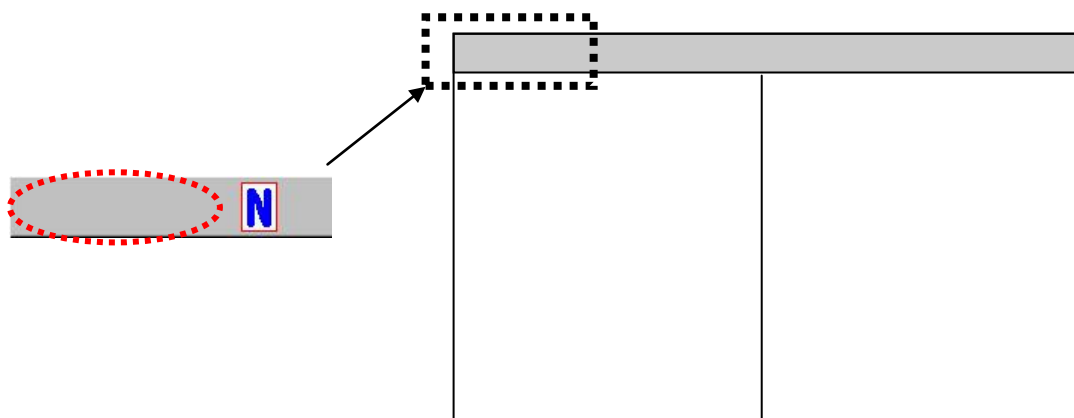

### Switching the range operation to “Change with [All Screens Same]” or to “Change with [Scr. Individual]:

1. Press [MENU] key .

2. The menu is displayed. Move the cursor to [Range Setup] with [▲] or [▼] keys of .

Echo Adjust	Range Operation	All Screens Same
TVG	Range1	5.0m
Disp. Setup1	Range2	10.0m
Disp. Setup2	Range3	20.0m
Range Setup	Range4	50.0m
Shift Setup	Range5	100m
BTM Search	Range6	150m
Alarm1	Range7	300m
Alarm2	Range8	500m
NAV	Return	
Image		
Manual Set		

3. Press [▶] of .

4. [Range Setup] of menu is displayed. Move the cursor to [Range Operation] with [▲] or [▼] of .

Echo Adjust	Range Operation	All Screens Same
TVG	Range1	5.0m
Disp. Setup1	Range2	10.0m
Disp. Setup2	Range3	20.0m
Range Setup	Range4	50.0m
Shift Setup	Range5	100m
BTM Search	Range6	150m
Alarm1	Range7	300m
Alarm2	Range8	500m
NAV	Return	
Image		
Manual Set		

5. Press [▶] key of .



6. [Range Operation] of menu is displayed. Moving the cursor with [▲] or [▼] keys of , select [All Screens Same] or [Scr. Individual].



7. When [MENU] key  is pressed, the menu disappears and the setup of range operation is complete.

Icon showing the range condition in header changes as follows:

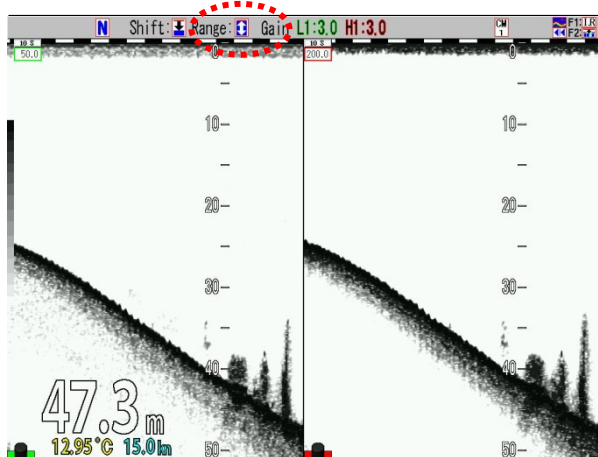

All Screens Same range

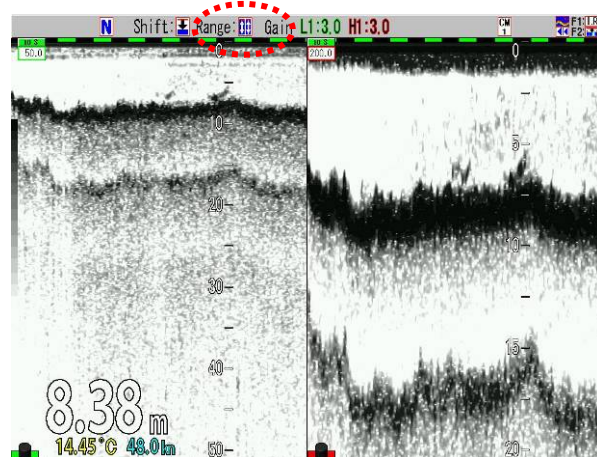

Scr. Individual range

 **Caution:** When [Scr. Individual] range is set, the speed of [Image Speed] will be the speed of the deepest range set.

**To register ranges:**

1. Press [MENU] key .

2. The menu is displayed. Move the cursor to [Range Setup] with [▲] or [▼] keys of .

Echo Adjust	Range Operation	All Screens Same
TVG	Range1	5.0m
Disp. Setup1	Range2	10.0m
Disp. Setup2	Range3	20.0m
<b>Range Setup</b>	Range4	50.0m
Shift Setup	Range5	100m
BTM Search	Range6	150m
Alarm1	Range7	300m
Alarm2	Range8	500m
NAV	Return	
Image		
Manual Set		

3. Press [▶] of .

4. [Range Setup] of the menu is displayed. Move the cursor to [Range1] with [▲] or [▼] keys of .

Echo Adjust	Range Operation	All Screens Same
TVG	<b>Range1</b>	5.0m
Disp. Setup1	Range2	10.0m
Disp. Setup2	Range3	20.0m
Range Setup	Range4	50.0m
Shift Setup	Range5	100m
BTM Search	Range6	150m
Alarm1	Range7	300m
Alarm2	Range8	500m
NAV	Return	
Image		
Manual Set		



5. Press [▶] key of .

6. [Range1] of the menu is displayed. Set range by increasing or decreasing numeric value with [▲] or [▼] keys of .

- The numeric value increases with [▲] key.
- The numeric value decreases with [▼] key.

When the key is kept pressed, the value automatically shifts to the upper digit.



7. When [SUBMENU] key  is pressed, the menu returns to [Range Setup].
8. For setup of the next range registration, the procedures 4 to 7 shall be repeated.
9. When [MENU] key  is pressed, the menu disappears and range registration is complete.

 **Hint:** It is recommended to assign smaller number to shallow range and larger number to deeper range. If so arranged, range key can be operated in such a way [▲] is for shallow direction and [▼] for deeper direction.

**To change ranges:**

1. When the header display is **N**, range of normal images can be changed.

If the header display is , press [NORMAL/ZOOM] key  to turn to **N**.

2. When [**▲**] of [RANGE] key  is pressed, the No. of the registered range turns one number smaller.

When [**▼**] is pressed, the No. turns one number larger.

When the range is changed, the range change box is displayed on the screen for 5 seconds.

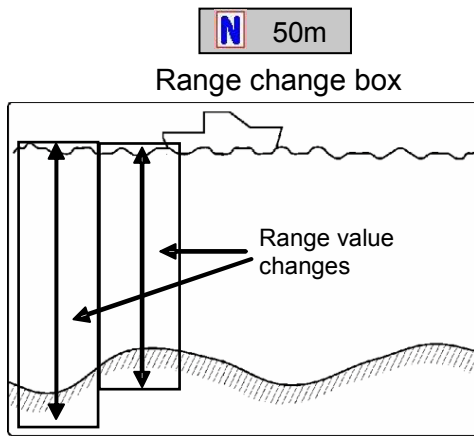

<Examples of display>

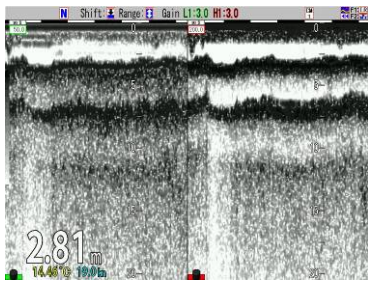

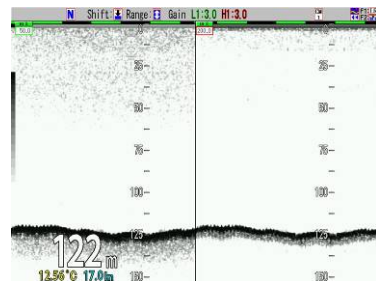

Shallow depth range



Deep depth range



**To switch the operation screen for individual range:**

1. At the left bottom corner of each screen, nothing is shown, or [Gain knob icon] of  (red) or  (green) is displayed.

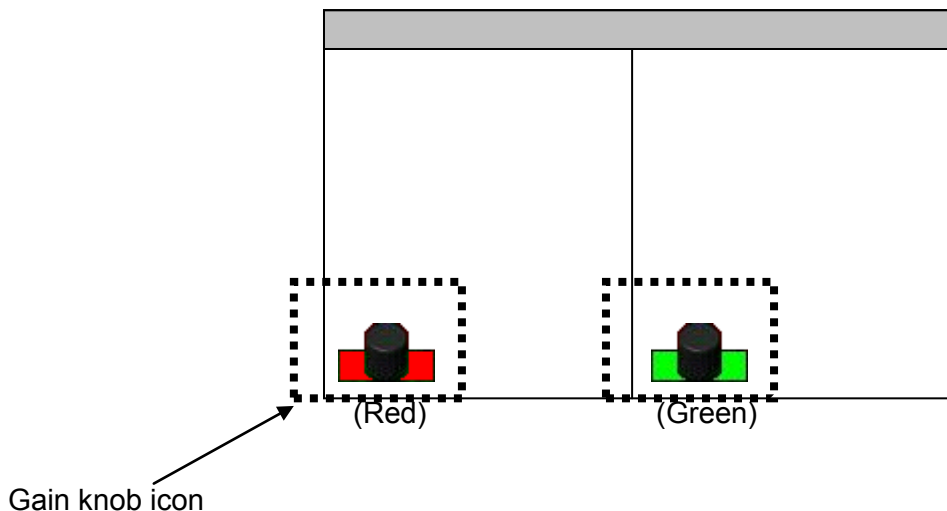
The range operation can be performed on the screen where [Gain knob icon]  (red) is displayed.



2. To switch over [Gain knob icon] to  (red), keep pressing [GAIN-L/SEL]  at left side, and [GAIN-R/SEL]  at right side pressed until [Gain knob icon] turns to  (red).

3. [Range] key  is pressed, the range of the screen with [Gain knob icon]  (red) changes.

### 2.2.4 Manual change of shift positions of normal images

When Range Mode is set at manual, shift can be changed manually.

In the manual shift, there are two ways: one is to change shift positions of 4-frequency images with [All Screens Same] and another is to change images per frequency with [Scr. Individual]. The manual shift can be switched over among 4 types of shift types, [Numeric Value], [Range Dependant], [Preset Value] and [Range Ratio].

In [Numeric Value], the shift value is changed directly.

In [Range Dependant], the shift value is changed to the most appropriate shift value specified per range.

In [Preset Value], each time shift key is pressed, 8 registered shift values switch in sequence.

In [Range Ratio], the shift value changes at every 1/5 of a range.

In addition, if [Shift digit input] is set at [F1] key **F1** or [F2] key **F2**, shift operation with a specified digit of shift value can be performed regardless of the operation mode above.

#### To set Range Mode at [Manual]:

1. Keep [SHIFT/M OFF] key **SHIFT (M) OFF** pressed until [Range Mode] menu is displayed.
2. Move the cursor with [**▲**] or [**▼**] keys of **◀ ▶ ▲ ▼** to select [Manual].

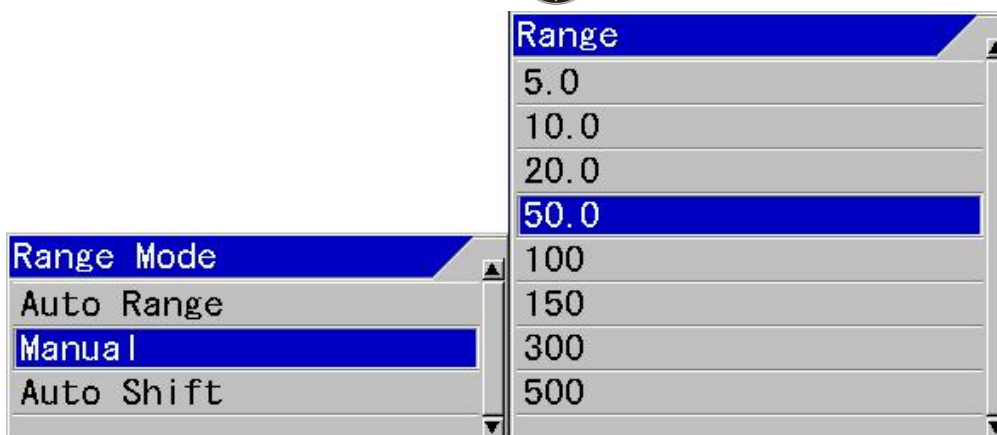



3. Press [ENT] key **ENT**. The mode is set at [Manual] and turns in manual shift.

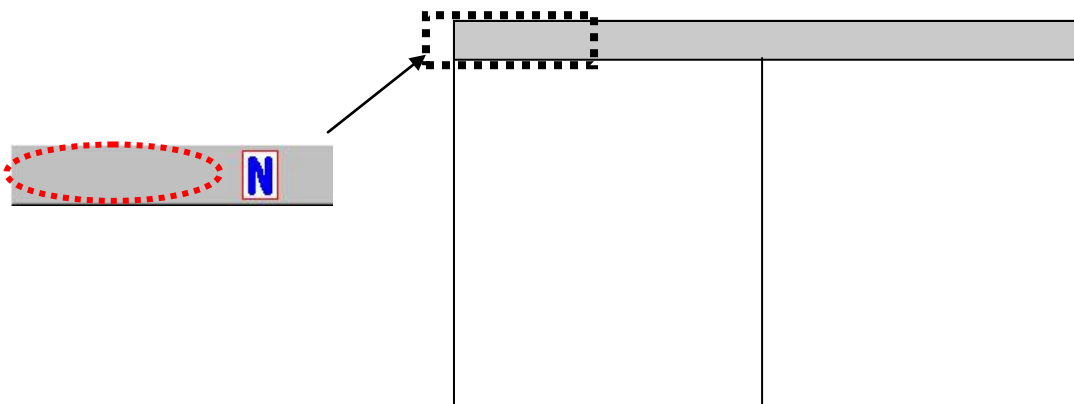

The header showing Range Mode disappears.



To switch shift operation into “Changes with [All Screens Same] “or “Change with [Scr. Individual]”:

1. Press [MENU] key  .
2. The menu is displayed. Move the cursor to [Shift Setup] with [▲] or [▼] keys of  .

Echo Adjust	Shift Operation	All Screens Same
TVG	Shift Type	Numerical Value
Disp. Setup1	Shift Preset1	10m
Disp. Setup2	Shift Preset2	20m
Range Setup	Shift Preset3	30m
<b>Shift Setup</b>	Shift Preset4	40m
BTM Search	Shift Preset5	50m
Alarm1	Shift Preset6	60m
Alarm2	Shift Preset7	70m
NAV	Shift Preset8	80m
Image	Zoom Shift Position	0.0m
Manual Set	Return	

3. Press [▶] of  .
4. [Shift Setup] of the menu is displayed. Move the cursor to [Shift Operation] with [▲] or [▼] keys of  .

Echo Adjust	<b>Shift Operation</b>	All Screens Same
TVG	Shift Type	Numerical Value
Disp. Setup1	Shift Preset1	10m
Disp. Setup2	Shift Preset2	20m
Range Setup	Shift Preset3	30m
Shift Setup	Shift Preset4	40m
BTM Search	Shift Preset5	50m
Alarm1	Shift Preset6	60m
Alarm2	Shift Preset7	70m
NAV	Shift Preset8	80m
Image	Zoom Shift Position	0.0m
Manual Set	Return	

5. Press [▶] key of  .

6. [Shift Operation] of the menu is displayed. Move the cursor with [▲] or [▼] keys of  and select [All Screens Same] or [Scr. Individual].



7. Press [MENU] key , and the menu disappears and the setup of shift operation is complete.

The icon showing the shift conditions in header display changes:

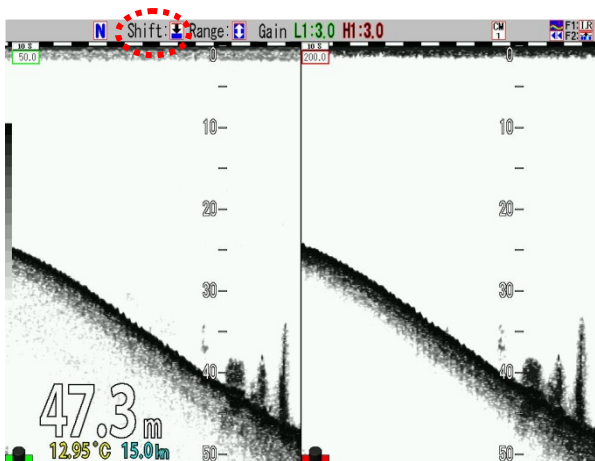

All Screens Same

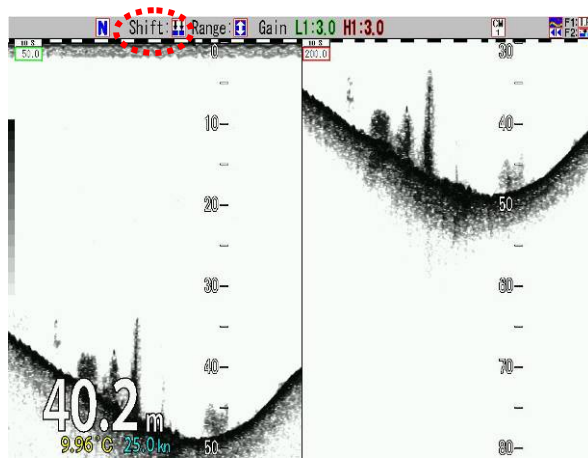



Scr. Individual

 **Caution:** When [Scr. Individual] is set, the speed of [Image Speed] turns to the speed of the deepest shift.



**To switch over the shift operation type:**

1. Press [MENU] key .
2. The menu is displayed. Move the cursor to [Shift Setup] with [▲] or [▼] keys of .

Echo Adjust	Shift Operation	All Screens Same
TVG	Shift Type	Numerical Value
Disp. Setup1	Shift Preset1	10m
Disp. Setup2	Shift Preset2	20m
Range Setup	Shift Preset3	30m
<b>Shift Setup</b>	Shift Preset4	40m
BTM Search	Shift Preset5	50m
Alarm1	Shift Preset6	60m
Alarm2	Shift Preset7	70m
NAV	Shift Preset8	80m
Image	Zoom Shift Position	0.0m
Manual Set	Return	

3. Press [▶] of .

4. [Shift Setup] of the menu is displayed. Move the cursor to [Shift Type] with [▲] or [▼] keys of .

Echo Adjust	Shift Operation	All Screens Same
TVG	<b>Shift Type</b>	Numerical Value
Disp. Setup1	Shift Preset1	10m
Disp. Setup2	Shift Preset2	20m
Range Setup	Shift Preset3	30m
Shift Setup	Shift Preset4	40m
BTM Search	Shift Preset5	50m
Alarm1	Shift Preset6	60m
Alarm2	Shift Preset7	70m
NAV	Shift Preset8	80m
Image	Zoom Shift Position	0.0m
Manual Set	Return	

5. Press [▶] of .

6. [Shift Type] of the menu is displayed. Move the cursor with [ $\blacktriangle$ ] or [ $\blacktriangledown$ ] keys of  and to select one of [Numerical Value], [Range Dependant], [Preset Value] or [Range Ratio].



7. Press [MENU] key , and the menu disappears and the setup of shift type is complete.

### Details of shift type:

#### 1. Numeric Value

When [Numerical Value] of [Shift type] is selected, [Numerical value] box is displayed.



Set the [Numerical Value] with [ $\blacktriangle$ ] or [ $\blacktriangledown$ ] keys of .

- With [ $\blacktriangleleft$ ] key, the digit can be moved to larger side.
- With [ $\blacktriangleright$ ] key, the digit can be moved to smaller side.
- With [ $\blacktriangle$ ] key, the numeric value increases.
- With [ $\blacktriangledown$ ] key, the numeric value decreases.

#### 2. Range Dependendent

Shift value varies for each range as described the following table.

Range	Shift value
1 ~ 7.5 m	1 m
10 ~ 20 m	2 m
25 ~ 40 m	5 m
50 ~ 90 m	10 m
100 ~ 240 m	20 m
260 ~ 450 m	50 m
500 ~ 900 m	100 m
1000 ~ 2400 m	200 m
2600 ~ 3000 m	500 m

3. Preset Value

Total 8 shift preset from [Main Menu], [Shift Setup], [Shift Preset1] to [Shift Preset8] can be switched each time shift key is pressed.

When [▲] of [Shift] key  is pressed, the shift changes to the registered range with one number smaller.

When [▼] of [Shift] key  is pressed, the shift changes to the registered range with one number greater.



This is an effective type of shift in the case where a constant shift value is specified depending on fishing.

4. Range Ratio

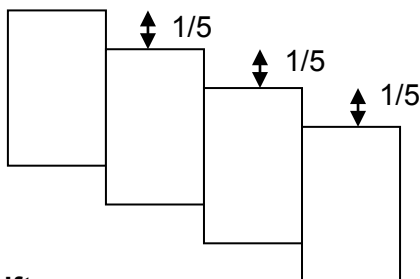
Independent of the range, it can shift at approximately 1/5 unit for the whole range:



To register shift:

1. Press [MENU] key  .
2. The menu is displayed. Move the cursor to [Shift Setup] with [▲] or [▼] keys of  .

Echo Adjust	Shift Operation	All Screens Same
TVG	Shift Type	Numerical Value
Disp. Setup1	Shift Preset1	10m
Disp. Setup2	Shift Preset2	20m
Range Setup	Shift Preset3	30m
Shift Setup	Shift Preset4	40m
BTM Search	Shift Preset5	50m
Alarm1	Shift Preset6	60m
Alarm2	Shift Preset7	70m
NAV	Shift Preset8	80m
Image	Zoom Shift Position	0.0m
Manual Set	Return	

3. Press [▶] key of  .

4. [Range Setup] of the menu is displayed. Move the cursor to [Shift Preset1] with [ $\blacktriangle$ ] or [ $\blacktriangledown$ ]

keys of  .



Echo Adjust	Shift Operation	All Screens Same
TVG	Shift Type	Numerical Value
Disp. Setup1	<b>Shift Preset1</b>	10m
Disp. Setup2	Shift Preset2	20m
Range Setup	Shift Preset3	30m
Shift Setup	Shift Preset4	40m
BTM Search	Shift Preset5	50m
Alarm1	Shift Preset6	60m
Alarm2	Shift Preset7	70m
NAV	Shift Preset8	80m
Image	Zoom Shift Position	0.0m
Manual Set	Return	

5. Press [ $\blacktriangleright$ ] key of  .

6. [Shift Preset1] of the menu is displayed. Set the range by increasing/decreasing of the numeric values with [ $\blacktriangle$ ] or [ $\blacktriangledown$ ] keys of  .

With [ $\blacktriangleleft$ ] key, the digit can be moved to larger side.  
 With [ $\blacktriangleright$ ] key, the digit can be moved to smaller side.  
 With [ $\blacktriangle$ ] key, the numeric value increases.  
 With [ $\blacktriangledown$ ] key, the numeric value decreases.







7. When [SUBMENU] key  is pressed, the menu returns to [Shift Setup].
8. To set the next shift preset, repeat the procedures 4 to 7.
9. Press [MENU] key  , and the menu disappears and the shift preset is complete.

 **Hint:** It is recommended to assign smaller number to shallow shift and larger number to deeper shift. If so arranged, shift key can be operated in such a way [ $\blacktriangle$ ] is for shallow direction and [ $\blacktriangledown$ ] for deeper direction.

**To change shift:**

1. When the header display is  , shift of normal images can change.

When the header display is  , press [NORMAL/ZOOM] key  to turn to  .

2. When [▲] of [Shift] key  is pressed, it shifts to shallow direction.

When [▼] of [Shift] key  is pressed, it shifts to deep direction.

In the case [Shift Type] is [Preset Value]:

When [▲] of [Shift] key  is pressed, the range changes to the registered range with one number smaller.

When [▼] of [Shift] key  is pressed, the range shifts to the registered range with one number greater.

When the shift is changed, a shift change box is displayed for 5 seconds at the upper side of the shift scale.

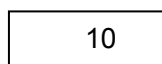

Shift change box

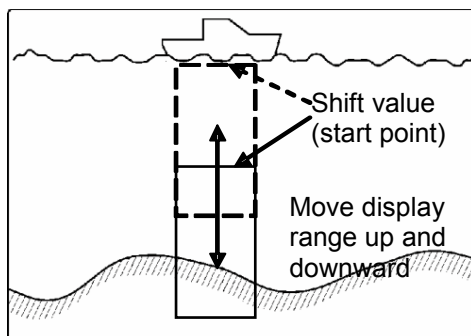

**To switch ON/OFF of shift:**

1. Each time [SHIFT/M OFF] key  is pressed , the shift is switched on or off.

The icon showing the shift conditions in header display changes:

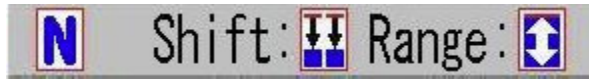

Shift at [Scr. Individual] : ON

Icon for shift status

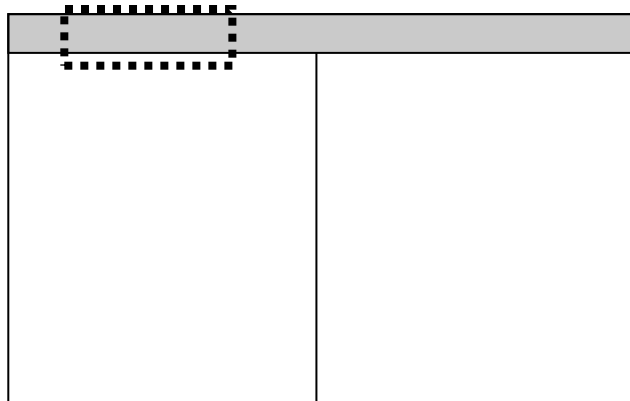





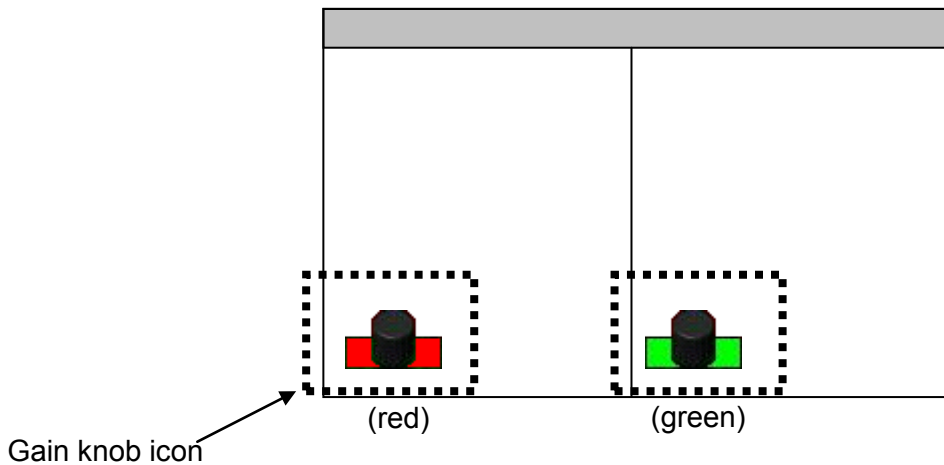

**To switch the operation screen for screen individual shift:**

1. At the lower left side of each screen, nothing is displayed or [Gain knob icon] of



Range operation can be performed on the screen where [Gain knob icon]  (red) is displayed.



- To turn [Gain knob icon] to  (red), press [GAIN-L/SEL]  for the left screen and [GAIN-R/SEL]  for the right screen until [Gain knob icon]  turns (red).
- When [Shift] key  is pressed, [Gain knob icon] turns to  (red) shift.

**[Shift Synchronized] (Shift digit input) by [F1]/[F2] key**

- If [Shift Synchronized] is set on [F1] key  or [F2] key  , shift can be changed in values regardless of the setup of [Shift Type].

As for the setup on [F1]/[F2] keys, please see “4.2.2 Assign intended operations to function keys ([F1]/[F2])”, p 4 - 2.

- Press [F1] key  or [F2] key  .

[Shift Synchronized] box is displayed:

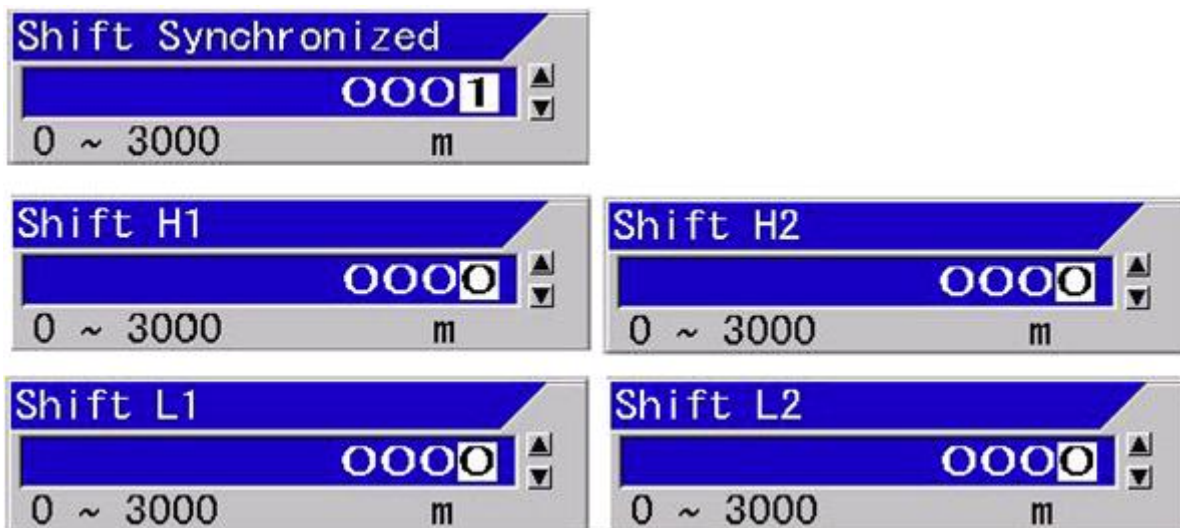

- Set range by increasing/decreasing numeric values with [▲] or [▼] keys of  .

The digit can be larger with [◀] key.  
 The digit can be smaller with [▶] key.  
 The value increases with [▲] key.  
 The value decreases with [▼] key.

**2.2.5 Adjustment of image gain**

On JFC-180BB, gain of 4-frequency images can be adjusted individually. For gain adjustment, there are two modes: individual mode and synchronized mode. In the individual mode, the gain is adjusted individually on a selected operation screen. In synchronized mode, the gain on all screens are adjusted all together by one gain adjustment knob after gain adjustment is optimized individually for each screens. In the synchronized gain, the gain of all screens change keeping the gain difference between screens. On JFC-180BB, the gain of all screens including images in the past changes by operation of the gain knobs. Also, it can be switched to a mode in which only the gain of the current image changes, to watch changes by the gain operation.

If the gain is increased too much, there is too much noise to make distinctions with signs of fish.



If the gain is decreased too much, images and fish signs become too faint to distinguish.

Adjust the gain to your preference while watching the image.

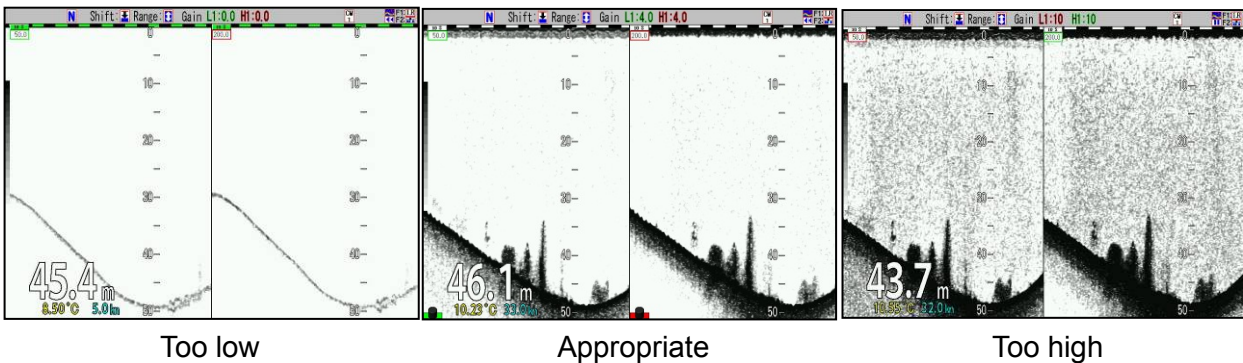
<Example of gain adjusted images>



**For gain adjustment (individual) per screen:**

1. At CM1, press [CM1] key (lights red [CM1] key) 
2. CM menu is displayed. Point the cursor to "Individual" of gain item with .

CM1	Low Frequency2	Low Frequency1	High Frequency2	High Frequency1
Standard	▶Normal	▶Normal	▶Normal	▶Normal
Echo Display	OFF	Mix	Mix	OFF
Frequency	38.0kHz	75.0kHz	130.0kHz	200.0kHz
Pulse Length	▶Short	▶Short	▶Short	▶Short
	▶Medium	▶Medium	▶Medium	▶Medium
	Long	Long	Long	Long
	Fixed	Fixed	Fixed	Fixed
Band Width	Narrow	Narrow	Narrow	Narrow
	▶Medium	▶Medium	▶Medium	▶Medium
	Wide	Wide	Wide	Wide
	Fixed	Fixed	Fixed	Fixed
Zoom Display	▶OFF	▶OFF	▶OFF	▶OFF
	Bottom	Bottom	Bottom	Bottom
	B.D.	B.D.	B.D.	B.D.
	Zoom	Zoom	Zoom	Zoom
	B.Z.	B.Z.	B.Z.	B.Z.
Gain	▶Individual			
	Synchronized			
Slide	38.0 75.0 130.0 200.0			
ENT :Enter	SUBMENU:Return			
▲▼◀▶ :Cursor	MENU :End			

Gain item



3. Press [ENT] key .

4. Press [CM1] key (lights red [CM] key)  to close CM menu.

**For adjustment of gain per screen (individually):**

- In the case of single frequency screen:

Regardless of frequency, operate with [GAIN-R/SEL] .

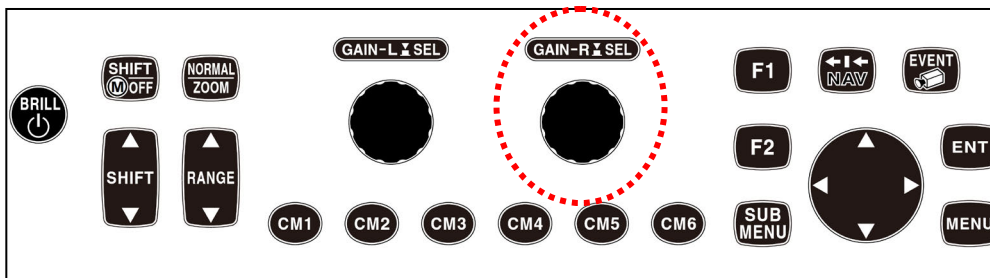



If [GAIN-R/SEL]  is turned to right, the gain increases, and the gain decreases if turned to left. The gain knob at the left side is invalid.

- In the case of dual frequency screen:

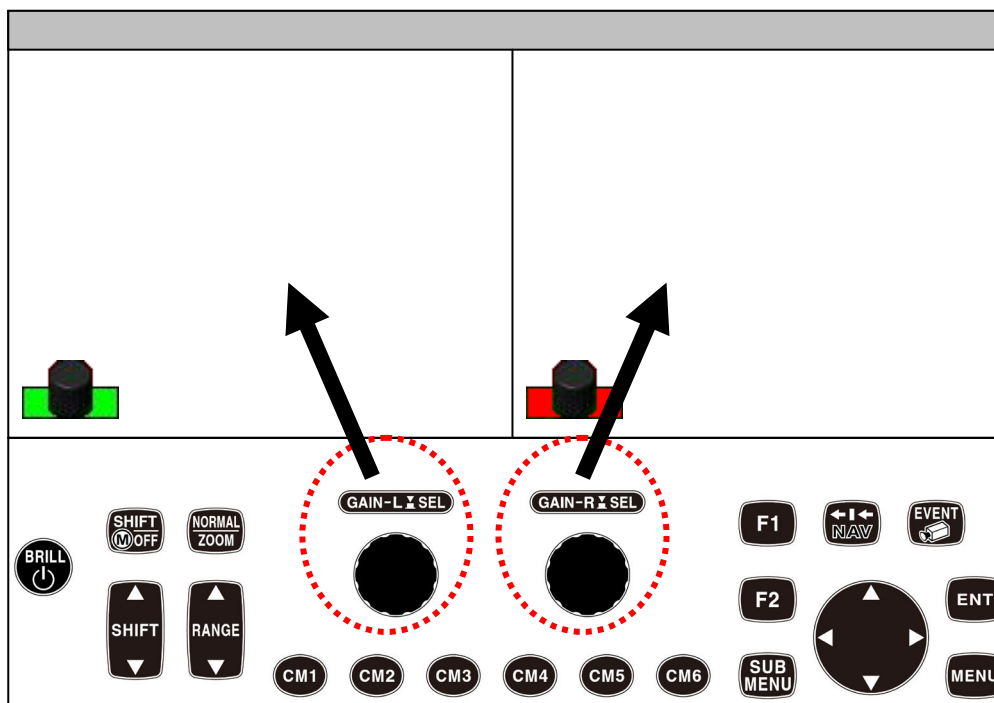

The gain for the left side screen is operated with [GAIN-L/SEL] 

and the right side with [GAIN-R/SEL] .







When [GAIN-L/SEL]  or [GAIN-R/SEL]  are turned to right, the gain increases, and when turned to left, the gain decreases.

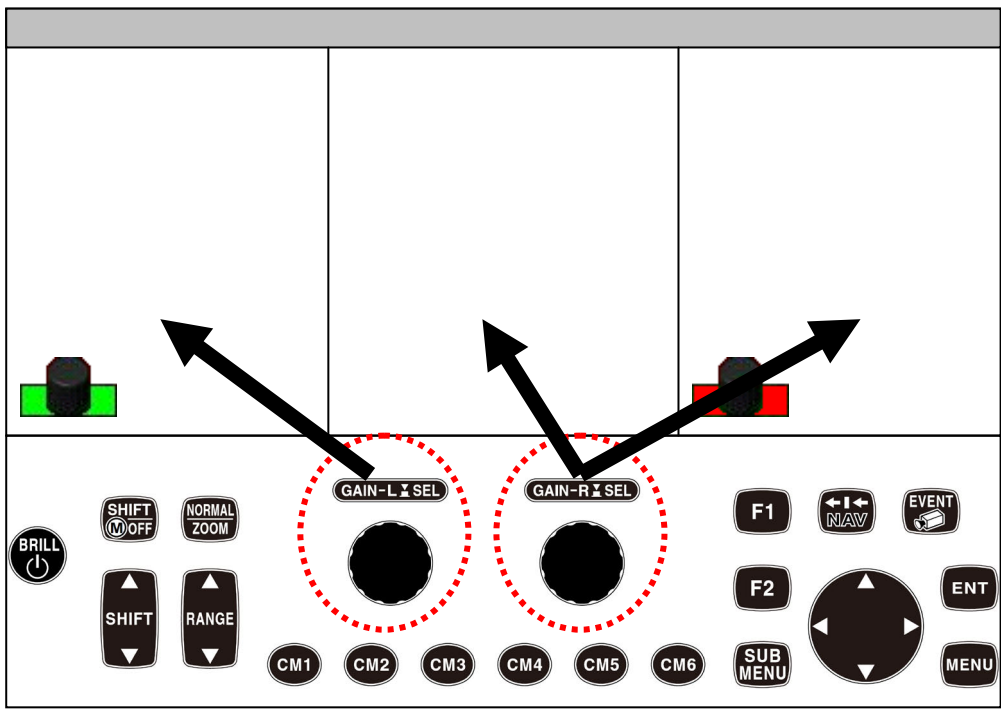

- In the case of 3-frequency screen:

Regardless of frequency, the gain at left side screen is operated with [GAIN-L/SEL]  , and the gain at the center screen and the right side screen are operated with [GAIN-R/SEL]  .





The gain can be adjusted of the screens on which  (red) or  (green) [Gain knob icon] on the lower left of screen are displayed.



When [GAIN-L/SEL]  and [GAIN-R/SEL]  are turned to right, the gain increases and when turned to left the gain decreases.

To switch gain adjustment at the center and the right side, press [Gain-R/SEL]  until [Gain knob icon]  (red) appears on the lower left of the aimed screen.

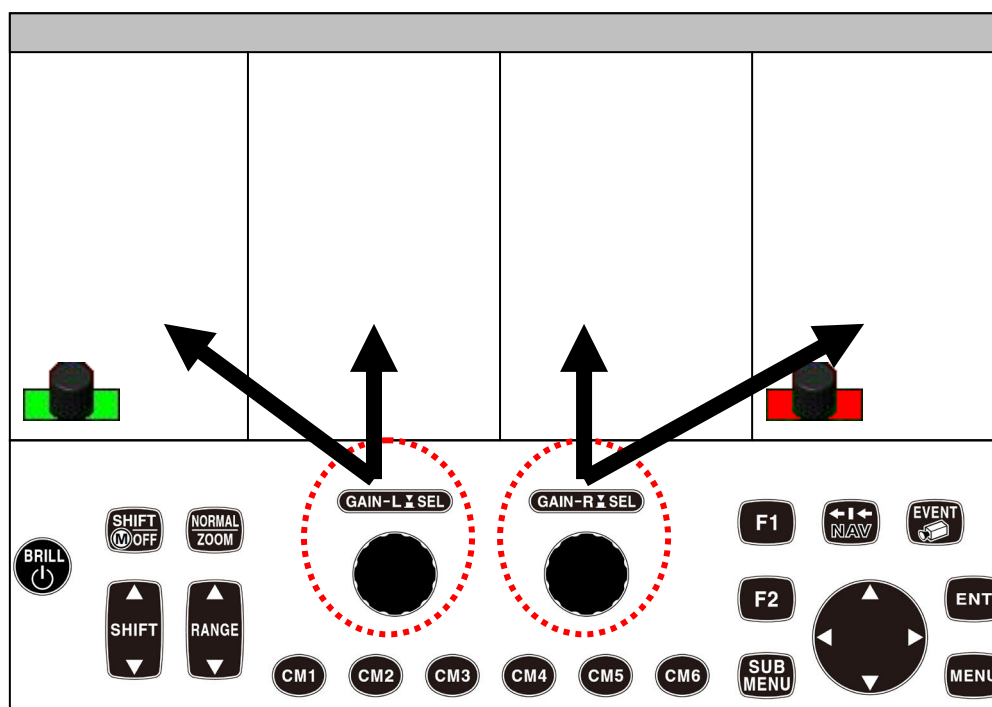

- In the case of 4-frequency screen:



Regardless of frequency, the gain of two left screens (Low frequency 2/Low frequency 1) is operated with [GAIN-L/SEL]  and the gain of two right screens (High frequency 2/High frequency 1) with [GAIN-R/SEL] .





The gain can be adjusted of the screen in which [Gain knob icon] of  (red) or  (green) is shown at the lower left of screen.



If [GAIN-L/SEL]  or [GAIN-R/SEL]  is turned to the right, the gain increases, and if turned to the left the gain decreases.



To switch the gain adjustment at left side (Low frequency 2/Low frequency 1), press [GAIN-L/SEL]  until [Gain knob icon] of  (red) appears at the lower left of the aimed screen.

To switch the gain adjustment at right side (High frequency 2/High frequency 1), press [GAIN-R/SEL]  until [Gain knob icon] of  (red) appears at the lower left of the aimed screen.

**To adjust the gain:**

The gain can be adjusted on the screens on which [Gain knob icon] of  (red) or  (green) is displayed at the lower left.

When gain knob is not displayed on the lower left of the screen of which the gain is intended to be adjusted keep [GAIN-L/SEL]  pressed for the left side (Low frequency 2/Low frequency 1) and [GAIN-R/SEL]  for right side (High frequency 2/High frequency 1) until [Gain knob icon] of  (red) appears at the lower left of the aimed screen.

When [GAIN-L/SEL]  is turned to the right in the left screen (Low frequency 2/Low frequency 1) or [GAIN-R/SEL]  in the right screen (High frequency 2/High frequency 1), the gain increases, and when turned to the left, the gain decreases.

When the gain knob is turned, gain adjustment box is displayed in the applicable operation effective screen and gain value is indicated. The numeric value and the progress bar increase or decrease depending on the operation.



At the same time, indication of gain values of the corresponding screen also increases/decreases in the header display also increases or decreases.

<Indication of gain values in header display>



Gain L2:5.0 L1:6.0 H2:7.0

L2:	L1:	H2:
Low frequency2	Low frequency1	High frequency2





**Caution:** The gain adjustment box automatically disappears after 5 seconds from completion of operation. It also disappears when the menu key is pressed. The gain value per screen is reflected in the header display.

**For gain adjustment of all screens at the same time (synchronized):**



1. At CM1, press [CM1] key  (Lights red [CM] key).
2. CM menu is displayed. Move the cursor to [Synchronized] of the Gain item with .

CM1	Low Frequency2	Low Frequency1	High Frequency2	High Frequency1
Standard	▶Normal	▶Normal	▶Normal	▶Normal
Echo Display	OFF	Mix	Mix	OFF
Frequency	38.0kHz	75.0kHz	130.0kHz	200.0kHz
Pulse Length	Short	Short	Short	Short
	▶Medium	▶Medium	▶Medium	▶Medium
	Long	Long	Long	Long
	Fixed	Fixed	Fixed	Fixed
Band Width	Narrow	Narrow	Narrow	Narrow
	▶Medium	▶Medium	▶Medium	▶Medium
	Wide	Wide	Wide	Wide
Zoom Display	Fixed	Fixed	Fixed	Fixed
	▶OFF	▶OFF	▶OFF	▶OFF
	Bottom	Bottom	Bottom	Bottom
	B.D.	B.D.	B.D.	B.D.
	Zoom	Zoom	Zoom	Zoom
Gain	B.Z.	B.Z.	B.Z.	B.Z.
	▶Individual	▶Individual	▶Individual	▶Individual
	Synchronized	Synchronized	Synchronized	Synchronized
	Gain	Gain	Gain	Gain

Gain item

3. Press [ENT] key .
4. Press [CM1] key  to close CM menu (lights red [CM] key)

At synchronized gain, operation of one gain knob can change the gain for maximum 4 screens (8 screens including zoom) at the same time, by increasing/decreasing with the same change step, from the gain of each screen set individually.

When gain is set in [Synchronized], [Gain knob icon]  (red) at the lower side of screens will turns to  (red).

 (red) indicates the screen where VRM operation is valid and when TVG is assigned to [F1/F2] keys.

To switch the active screens for VRM and [F1]/[F2] keys, press [GAIN-L/SEL]







for left screen, [GAIN-R/SEL]



for right screen.

**For gain adjustment of all screens at same time (synchronized):**

1. If [GAIN-L/SEL]  or [GAIN-R/SEL]  is turned, the [Synchronized Gain] box is displayed.

This [Synchronized Gain] box indicates amount of change in  $\pm$  value commonly given to the gain individually set per each screen.



2. If [GAIN-L/SEL]  or [GAIN-R/SEL]  is turned to the right, the gain increases, and if turned to the left, the gain decreases.

The gain of all screens can be changed simultaneously taking the gain of each screen as reference.

 **Caution:** Synchronized gain adjustment box disappears automatically after 5 seconds from the completion of operation. It also disappears by pressing of the menu key.

The values of gain per screen plus the adjusted value of synchronized gain is indicated in the header display

<Example of indication>

Changing the synchronized gain to 1.0

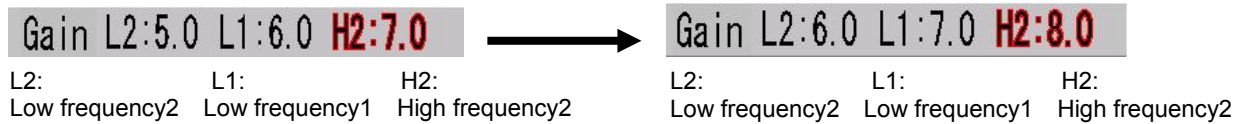

**Types of gain change:**

There are two types of gain change when gain adjustment is done with a gain knob. One is that the gain of all screens including images in the past is changed and the other is that only the gain of the current mages is changed.

<Examples of images of gain change types>

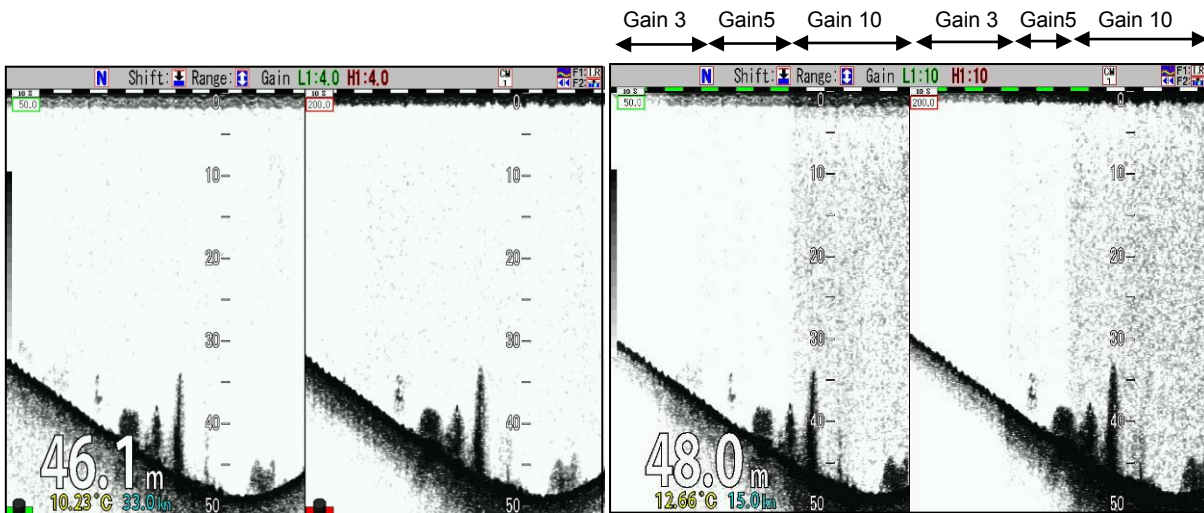

All screens

Current images only

**To switch over change type of gain:**

1. Press [SUBMENU] key .

2. The SUBMENU is displayed. Move the cursor to [System] with [▲] or [▼] keys of .

<b>System</b>	Event Key Usage	Store Image
Source	FUNC1.Key Setting	Image Title
NMEA 1	FUNC2.Key Setting	IR
NMEA 2	Guide Window	ON
Correct	Func. Guide Window	ON
Heaving	Header Display	ON
TD Setting	Simple Menu	OFF
Basics	CM Key Usage	CM
Customize	Gain Type	Retractive Gain
Maintain	Bubble	OFF
Network	Clock Display	OFF
	Return	

3. Press [▶] key of .

4. [System] of the SUBMENU is displayed. Move the cursor to [Gain Type] with [▲] or [▼] keys of .

System	Event Key Usage	Store Image
Source	FUNC1.Key Setting	Image Title
NMEA 1	FUNC2.Key Setting	IR
NMEA 2	Guide Window	ON
Correct	Func. Guide Window	ON
Heaving	Header Display	ON
TD Setting	Simple Menu	OFF
Basics	CM Key Usage	CM
Customize	<b>Gain Type</b>	Retractive Gain
Maintain	Bubble	OFF
Network	Clock Display	OFF
	Return	

5. Press [▶] key of .

6. [Gain Type] of the SUBMENU is displayed. Move the cursor to [Retractive Gain] or [Current Image] with [▲] or [▼] keys of .



7. Press [MENU] key , and the SUBMENU disappears and the selected [Gain Type] is set.



**Caution:** When the Gain Type is switched, the color of the past images changes. This is because that the display method of images for the switched gain type and that of previous type are different.  
After scroll of one screen, normal images will be on display.



**2.2.6 Adjustment of TVG**

The reflected signals of echo sounder have less sensitivity due to attenuation, as depth is deeper.

This means that the same fish schools at shallower positions are displayed stronger and those at deeper positions are displayed weaker.

TVG is the function, according to the characteristics of ultrasonic sound, to correct the reflected signals attenuated according to their depth and to equalize the gain of the images along the change of depth.



In the range of depth where TVG function is effective, fish schools of the same size can be displayed with the same sensitivity even when their depth is different.

Method of TVG can be switched over between [Optimized] and [Manual].

[Optimized] is the mode with gain correction depending on the depth, based on the correction curve optimized by diffusional attenuation and absorption attenuation depending on frequency of ultrasonic.

[Manual] is the mode to adjust the setting of [Strength], [Depth] and [Adjust] to fit the images to preference.

**To switch between [Optimized] and [Manual]:**

1. Press [MENU] key  .
2. The menu is displayed. Move the cursor to [TVG] with [▲] or [▼] keys of  .

Echo Adjust	TVG Type	Optimized
<b>TVG</b>	TVG Strength HF1	1
Disp. Setup1	TVG Depth HF1	50m
Disp. Setup2	TVG Adjust HF1	2m
Range Setup	TVG Strength HF2	1
Shift Setup	TVG Depth HF2	50m
BTM Search	TVG Adjust HF2	2m
Alarm1	TVG Strength LF1	1
Alarm2	TVG Depth LF1	50m
NAV	TVG Adjust LF1	2m
Image	TVG Strength LF2	1
Manual Set	TVG Depth LF2	50m
	TVG Adjust LF2	2m
	Return	

3. Press [▶] key of  .

4. [TVG] of the menu is displayed. Move the cursor to [TVG Type] with [▲] or [▼] keys of .

Echo Adjust	<b>TVG Type</b>	Optimized
TVG	TVG Strength HF1	1
Disp. Setup1	TVG Depth HF1	50m
Disp. Setup2	TVG Adjust HF1	2m
Range Setup	TVG Strength HF2	1
Shift Setup	TVG Depth HF2	50m
BTM Search	TVG Adjust HF2	2m
Alarm1	TVG Strength LF1	1
Alarm2	TVG Depth LF1	50m
NAV	TVG Adjust LF1	2m
Image	TVG Strength LF2	1
Manual Set	TVG Depth LF2	50m
	TVG Adjust LF2	2m
	Return	

5. Press [▶] of .

6. [TVG Type] of the menu is displayed. Move the cursor and select [Manual] or [Optimized] with [▲] or [▼] keys of .

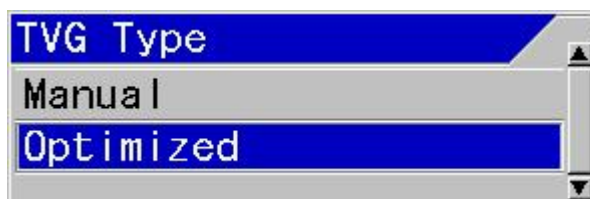

7. Press [MENU] key , and the menu disappears and the selected TVG is set.

**To use of optimized TVG:**

- Optimized TVG corrects the reflected signal from shallower than the [Depth] where color is produced with maximum level. This is done by having room for gain adjustment, in reference to the diffusional attenuation and absorption attenuation of ultrasonic sound.
- By optimized TVG, unnecessary reflection such as noise is eliminated, and necessary reflection from single fish and fish schools is clearly displayed at the same sensitivity regardless of their depth.
- As optimized TVG always corrects optimized TVG, no adjustment is basically needed. Only fitting to a desired gain with a gain knob is required.  
However, when it is felt that the gain is short due to the excess correction of TVG for shallower range, please adjust to a desired gain by changing the [Adjust].

<Example of optimized TVG images>

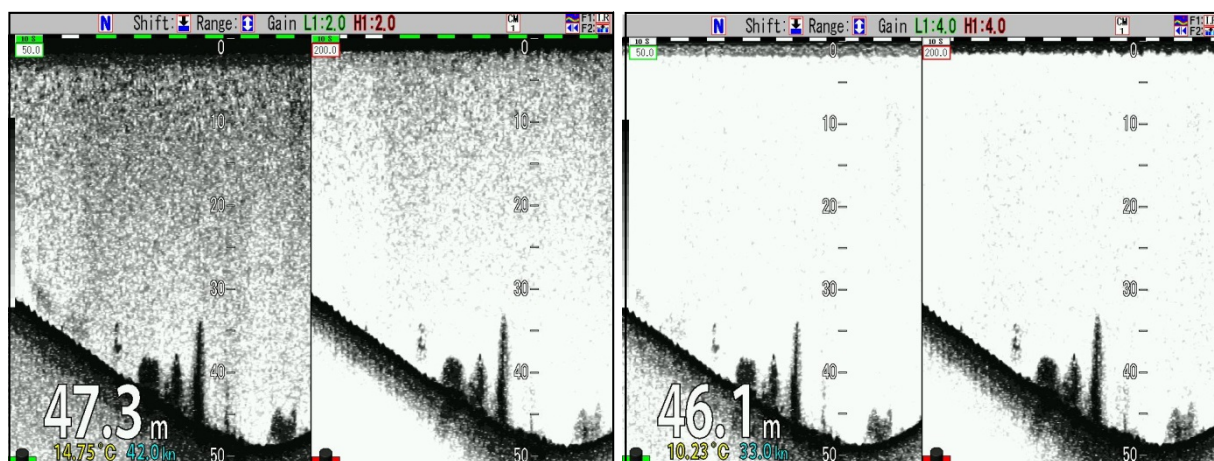



Without TVG

Optimized TVG

**When adjustment is needed due to excess TVG correction for shallower range:**

There are two ways of TVG adjustment: to adjust in the main menu and to assign [F1]/[F2] keys to adjust by the function keys.

**To adjust TVG Adjust in main menu:**

1. Press [MENU] key .
2. The menu is displayed. Move the cursor to [TVG] with [▲] or [▼] keys of .

Echo Adjust	TVG Type	Optimized
<b>TVG</b>	TVG Strength HF1	1
Disp. Setup1	TVG Depth HF1	50m
Disp. Setup2	TVG Adjust HF1	2m
Range Setup	TVG Strength HF2	1
Shift Setup	TVG Depth HF2	50m
BTM Search	TVG Adjust HF2	2m
Alarm1	TVG Strength LF1	1
Alarm2	TVG Depth LF1	50m
NAV	TVG Adjust LF1	2m
Image	TVG Strength LF2	1
Manual Set	TVG Depth LF2	50m
	TVG Adjust LF2	2m
	Return	

3. Press [▶] key of .

4. [TVG] of the menu is displayed. Move the cursor to [TVG Adjust HF1] with [▲] or [▼] keys of .

Echo Adjust	TVG Type	Optimized
TVG	TVG Strength HF1	1
Disp. Setup1	TVG Depth HF1	50m
Disp. Setup2	<b>TVG Adjust HF1</b>	2m
Range Setup	TVG Strength HF2	1
Shift Setup	TVG Depth HF2	50m
BTM Search	TVG Adjust HF2	2m
Alarm1	TVG Strength LF1	1
Alarm2	TVG Depth LF1	50m
NAV	TVG Adjust LF1	2m
Image	TVG Strength LF2	1
Manual Set	TVG Depth LF2	50m
	TVG Adjust LF2	2m
	Return	

5. Press [▶] key of .





6. [TVG Adjust HF1] of the menu is displayed. Set [TVG Adjust HF1] by increasing and decreasing the numeric value with [▲] or [▼] keys of .

With [▲] key, the value increases.  
 With [▼] key, the value decreases.





- 7. Press [SUBMENU] key  to return to [TVG].
- 8. To set the next [TVG Adjust HF2], repeat the procedures 4 to 7.

**To adjust TVG Adjust with [F1]/[F2] keys:**



- 1. At first, assign [MENU] key  or [F2] key  with [TVG].  
 As for the setup method of [F1]/[F2] keys, see “4.2.2 Assign intended operation to function keys ([F1]/[F2])”, p 4 - 2.
- 2. Press [F1] key  or [F2] key .
- 3. The [TVG Adjust XXX] box is displayed.



4. Select the screen for adjustment of TVG.



When the left hand screen is to be selected, press [GAIN-L/SEL] , and when the right hand screen is to be selected, press [GAIN-R/SEL]  to show [Gain knob icon]  blinking at the lower left on the screen to be operated.

The title display of [TVG Adjust XXX] box changes to [TVG Adjust LF1] [TVG Adjust LF2] or [TVG Adjust HF1] [TVG Adjust HF2].

 **Caution:** [Gain knob icon] at the lower left of the screen changes to  (red) when gain setting is [Individual] and to  (red) when [Synchronized].

5. Adjust the numeric value with [▲] or [▼] keys of  to set [TVG Adjust HF1].  
 With [▲] key, the value increases.  
 With [▼] key, the value decreases.



6. Press [SUBMENU] key  or [MENU] key  , and [TVG Adjust XXX] box disappears.

 **Caution:** [TVG Adjust XXX] box automatically disappears 5 seconds after release of a key.

**To adjust with manual TVG:**

There are two ways of TVG adjustment: to adjust in the main menu and to assign [F1]/[F2] keys to adjust by the function keys.

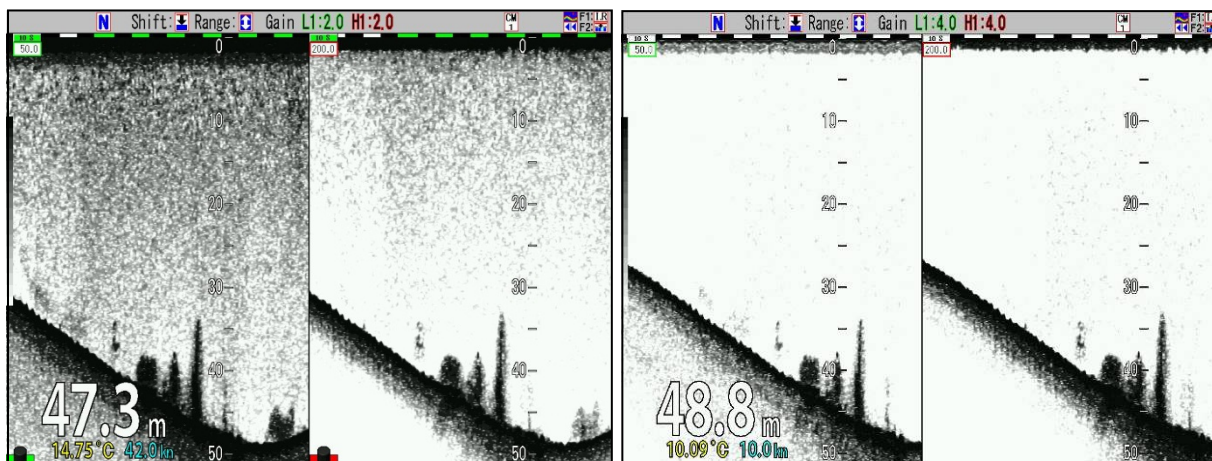

<Examples of manual TVG images>



Without TVG

Manual TVG

**To manually adjust TVG in main menu:**

1. Press [MENU] key  .
2. The main menu is displayed. Move the cursor to [TVG] with [▲] or [▼] keys of  .

Echo Adjust	TVG Type	Manual
<b>TVG</b>	TVG Strength HF1	25
Disp. Setup1	TVG Depth HF1	50m
Disp. Setup2	TVG Adjust HF1	2m
Range Setup	TVG Strength HF2	25
Shift Setup	TVG Depth HF2	50m
BTM Search	TVG Adjust HF2	2m
Alarm1	TVG Strength LF1	25
Alarm2	TVG Depth LF1	50m
NAV	TVG Adjust LF1	2m
Image	TVG Strength LF2	25
Manual Set	TVG Depth LF2	50m
	TVG Adjust LF2	2m
	Return	

3. Press of [▶] key of  .

4. [TVG] of the menu is displayed. Move the cursor to [TVG Strength HF1] with [▲] or [▼] keys of  .



Echo Adjust	TVG Type	Manual
TVG	<b>TVG Strength HF1</b>	25
Disp. Setup1	TVG Depth HF1	50m
Disp. Setup2	TVG Adjust HF1	2m
Range Setup	TVG Strength HF2	25
Shift Setup	TVG Depth HF2	50m
BTM Search	TVG Adjust HF2	2m
Alarm1	TVG Strength LF1	25
Alarm2	TVG Depth LF1	50m
NAV	TVG Adjust LF1	2m
Image	TVG Strength LF2	25
Manual Set	TVG Depth LF2	50m
	TVG Adjust LF2	2m
	Return	

5. Press [▶] key of  .

6. [TVG Strength HF1] of the menu is displayed. Increase or decrease the numeric value with [▲] or [▼] keys of  to set [TVG Strength HF1].





With [▲] key, the value increases.  
With [▼] key, the value decreases.



7. Press [SUBMENU] key  to return to [TVG].
8. Point the cursor to [TVG Depth HF1] with [▲] or [▼] keys of .
9. Press [▶] key of .

10. [TVG Depth HF1] of the menu is displayed. Set [TVG Depth HF1] by increasing or decreasing the numeric value with [▲] or [▼] keys of .
- With [▲] key, the value increases.  
With [▼] key, the value decreases.







11. Press [SUBMENU] key  to return to [TVG].
12. Point the cursor to [TVG Adjust HF1] with [▲] or [▼] keys of .
13. Press [▶] key of .
14. [TVG Adjust HF1] of the menu is displayed. Set [TVG Adjust HF1] by increasing or decreasing the numeric value with [▲] or [▼] keys of .
- With [▲] key, the value increases.  
With [▼] key, the value decreases.



15. Press [SUBMENU] key  to return to [TVG].
16. For setting of the next TVG, repeat the procedures 4 to 15.





**To manually adjust TVG with [F1]/[F2] keys:**

1. At first, assign [MENU] key  or [F2] key  with [TVG].  
As for the setting method of [F1]/[F2] keys, see “4.2.2 Assign intended operation to function keys ([F1]/[F2])”, p 4 - 2.
2. Press [F1] key  or [F2] key .
3. TVG adjustment box is displayed.

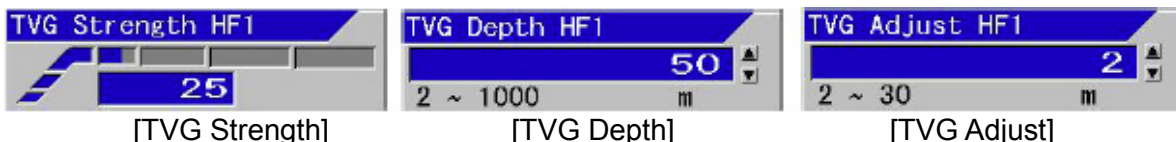

Each time [F1] key or [F2] key is pressed, the TVG adjustment box will switched over among [TVG Strength], [TVG Depth] and [TVG Adjust]. Select the intended item.



4. Select the screen to perform TVG adjustment.



When the screen at the left side is selected, press [GAIN-L/SEL] , and when the screen at the right side is selected, press [GAIN-R/SEL]  to make  (red) blinking at the lower left of the screen to be adjusted.

The title display of TV adjustment box will change to [TVG XX LF1] and [TVG XX LF2], or [TVG XX HF1] and [TVG XX HF2].

**Caution:** [Gain knob icon] at the lower left of the screen changes to  (red) when gain setting is [Individual] and to  (red) when [Synchronized].

5. In the case of [TVG Strength HF1], set [TVG Strength HF1] by increasing and decreasing the numeric value with [▲] or [▼] keys of .  
With [▲] key, the value increases  
With [▼] key, the value decreases



6. Press [SUBMENU] key  or [MENU] key , and [TVG Strength XXX] box disappears.



**Caution:** [TVG Strength XXX] box automatically disappears 5 seconds after release of a key.

7. In the case of [TVG Depth HF1], set [TVG Depth HF1] by increasing or decreasing the numeric value with [▲] or [▼] keys of .

With [▲] key, the value increases.

With [▼] key, the value decreases



8. Press [SUBMENU] key  or [MENU] key  , and [TVG Depth XXX] box disappears.





**Caution:** [TVG Depth XXX] box automatically disappears 5 seconds after release of a key.

9. In the case of [TVG Adjust High 1], set [TVG Adjust HF1] by increasing or decreasing the numeric value with [▲] or [▼] keys of .

With [▲] key, the value increases.

With [▼] key, the value decreases.



10. Press [SUBMENU] key  or [MENU] key  , and [TVG Adjust XXX] box disappears.



**Caution:** [TVG Adjust XXX] box automatically disappears 5 seconds after release of a key.

**To manually correct TVG:**

The reflected signals of echo sounder have less sensitivity due to attenuation, as depth is deeper.

In the TVG correction for JFC-180BB, a reference point of depth for correction is to be determined. This reference point is [TVG Depth].

Reflected signals from a shallower depth than this reference point are corrected to have the same sensitivity as that of the reference point.

In [Strength], the amount of change in this correction is set. The larger the value of [Strength] becomes, the larger the amount of change becomes. (See the figure below)

For reflected signals from shallower positions, amount of correction becomes larger. When [Strength] is set large, the correction amount for shallow depth may seem too much. In such cases, if the [Adjust] is set at the depth at which correction seems too much, the correction amount at shallower depth than the depth becomes the same as the correction amount at the starting position, and can set off the over correction.

Setting should be performed in combination of the items above.

**Adjustment of TVG strength of manual TVG:**

[TVG Strength] decides the amount of change for TVG correction. The larger the value of [TVG Strength] is, the bigger the amount of change is.

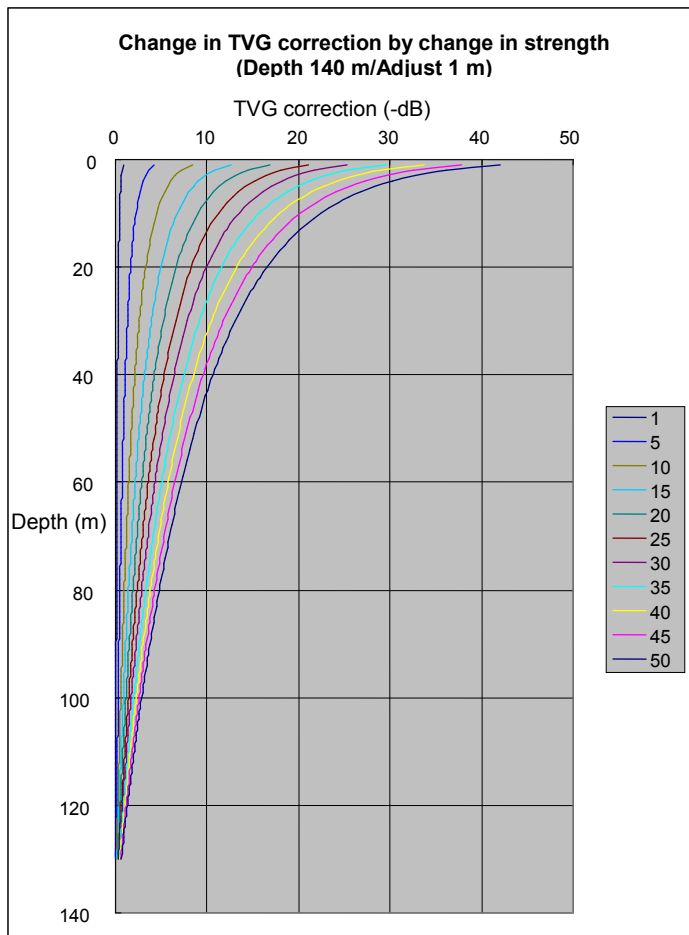

The far left side line is Strength 1 and the far right side line is Strength 50 in the graph.

**Adjustment of TVG Depth of manual TVG**

[TVG Depth] is the reference point of depth for correction. The deeper the setup becomes, the wider the correction range becomes.

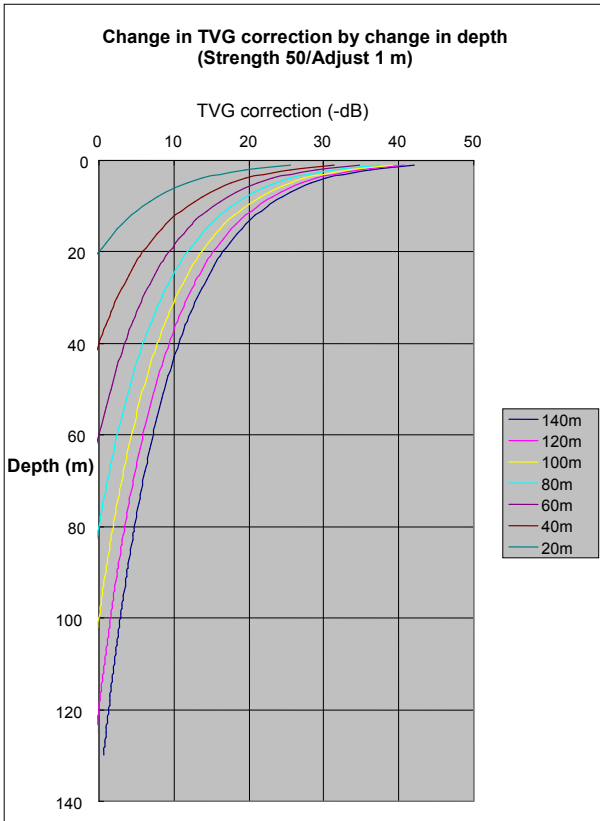

The far left line is at correction depth 20 m, and the line at far right is at correction depth 140 m in the graph.

**Adjustment of TVG Adjust (start point) of manual TVG**

[TVG Adjust] adjusts the excessive correction by TVG against shallow signals, making the amount of correction at the point shallower than the start point to be the same correction amount at the start point.

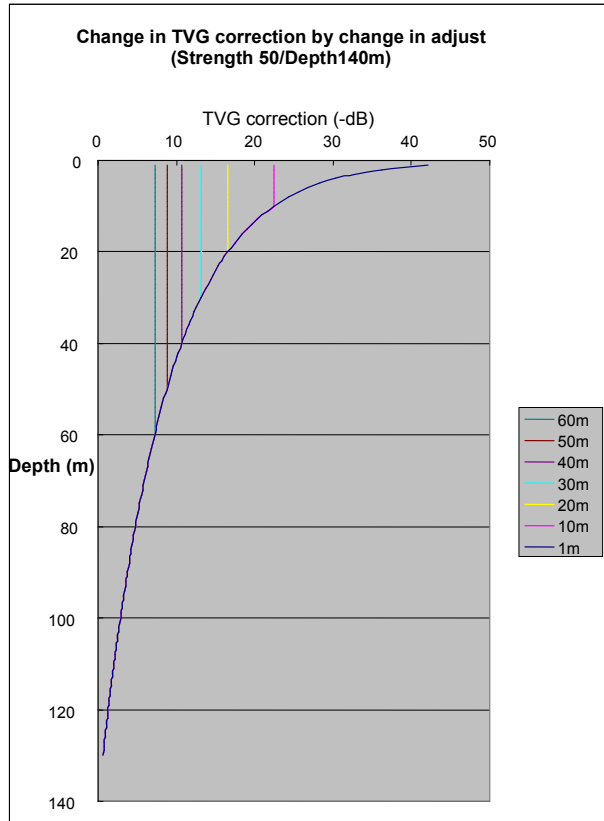

The far left line is at correction depth 60 m, and the line at far right is at correction depth 1 m in the graph.

**2.3 Changing of the image scroll speed**

The image scroll speed can be changed at 14 steps of [Speed -2], [Speed -1], . . . [Stop], [Speed 2], . . . [Speed 9]. The larger the speed number is, the slower the image scroll speed becomes.

The image scroll speed of echo sounders is faster for shallow ranges and slower for deeper ranges depending on the display ranges.

When the image speed at shallow ranges seems too fast, [Image Speed] is used to make the speed slower.

When sea bottom is bedrock and has strong reflection strength, the multipath reflection between seawater surfaces remains as reverb and **may display false image\*<sup>1</sup>**. To **eliminate the false images**, the image scroll speed may be slowed down to wait the next transmission and reception until the reverb disappears.

The scroll of images can be stopped.

Speed 0 : The image scroll speed is 2 times faster by enlarging the original image 2 times.  
 Speed -2: The image scroll speed is 4 times faster by enlarging the original image 4 times.

**To change image scroll speed:**

1. Press [Image Speed] key .

[Image Speed] adjustment box is displayed.

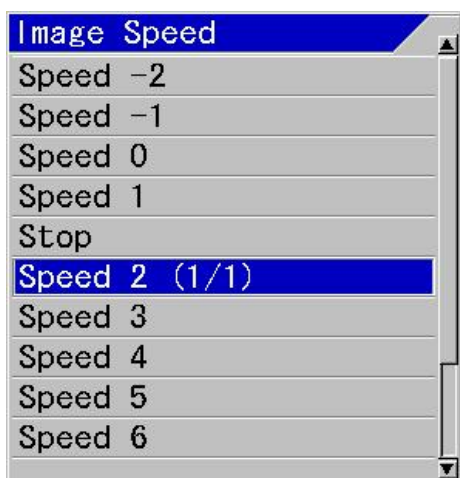

Speed -2	4 times faster
Speed -1	3 times faster
Speed 0	2 times faster
Speed 1	1.5 times faster
Speed 2	Normal speed
Speed 3	↓ The image speed becomes slow in order.
Speed 4	
Speed 5	
Speed 6	
Speed 7	
Speed 8	
Speed 9	

**To speed up image scroll speed:**

1. While [Image Speed] adjustment box is displayed, press [Image Speed] key  .  
 Move upward the cursor, and [Image Speed] is set to a faster speed.

\*<sup>1</sup>False image: When sea bottom material is bedrock with high reflection ratio of ultrasonic sound, the reflected signals at the sea bottom are reflected by the seawater surface and again by the sea bottom. This may be repeated many times. This repeat of reflection remains as reverb. If the reverb remains at the next transmission and reception, the image is a mixture with normal reflection and the reverb. This reverb is called as false images.

**To stop image scroll:**

1. While [Image Speed] adjustment box is displayed, move the cursor to [Stop] with [▲] key



When the cursor is at [Speed 2 (1/1)], press [Image speed] key , and the cursor moves to [Stop].

**To slow down image scroll speed:**

1. While [Image Speed] adjustment box is displayed, move the cursor downward with [▼] key

**To wipe out false images:**

1. While [Image Speed] adjustment box is displayed, move the cursor one step down with [▼]

key of  to observe images.

While false images remain, move the cursor one more step down and observe the image.

Repeat this operation and adjust the image speed by making slower until the false images disappear.

**2.4 Finding out depth of targets in images (VRM operation)**

VRM (Variable Range Marker) is a mobile marker to measure the depth of targets such as fish schools, and indicates lines and depth values of the lines.

This can be also used as an indication of depth for casting net, etc.

VRM can display the second VRM set at a certain interval under the first VRM. This second VRM follows the movement of the first one with the interval. This can be used as a measure for depth of casting net.

There are two modes: to display a line on only one screen of the 4 frequencies and to display one across the all 4 screens.

In the display on the whole screen mode, the same depth is indicated on all screens at synchronized range/shift. Display and operation can be done on each screen at individual range/shift.

<Example of display VRM on specific screen>

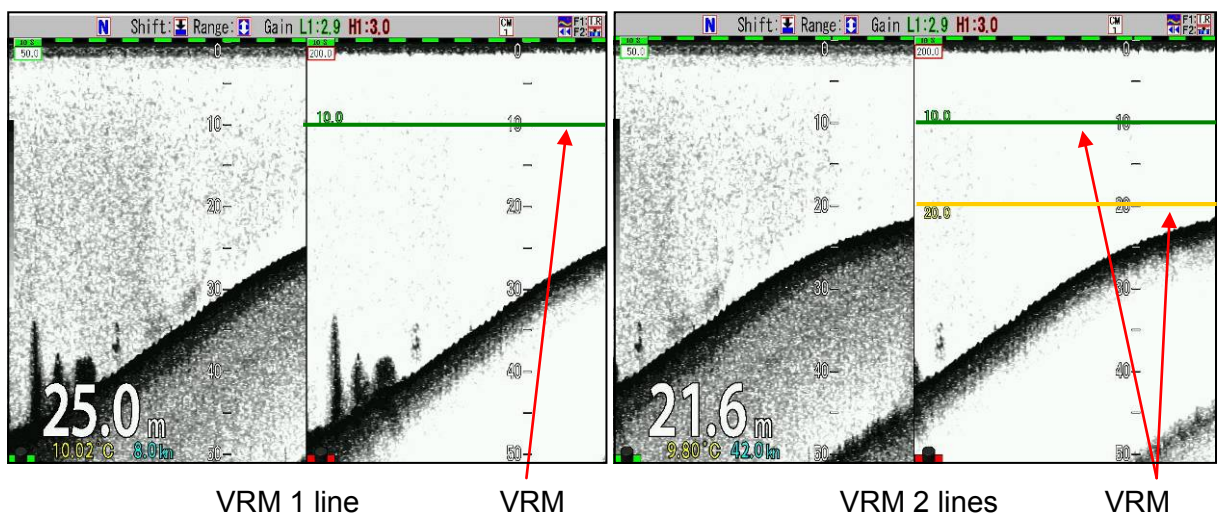

<Example of display of VRM whole screen (All screens same range)>

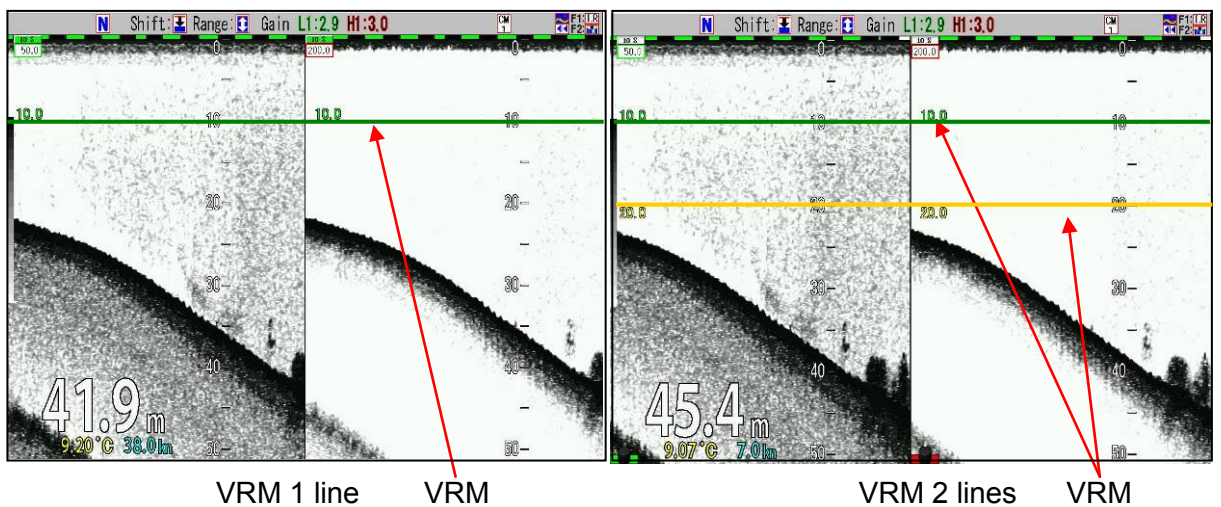

<Example of display of VRM whole screen (Screen individual range)>

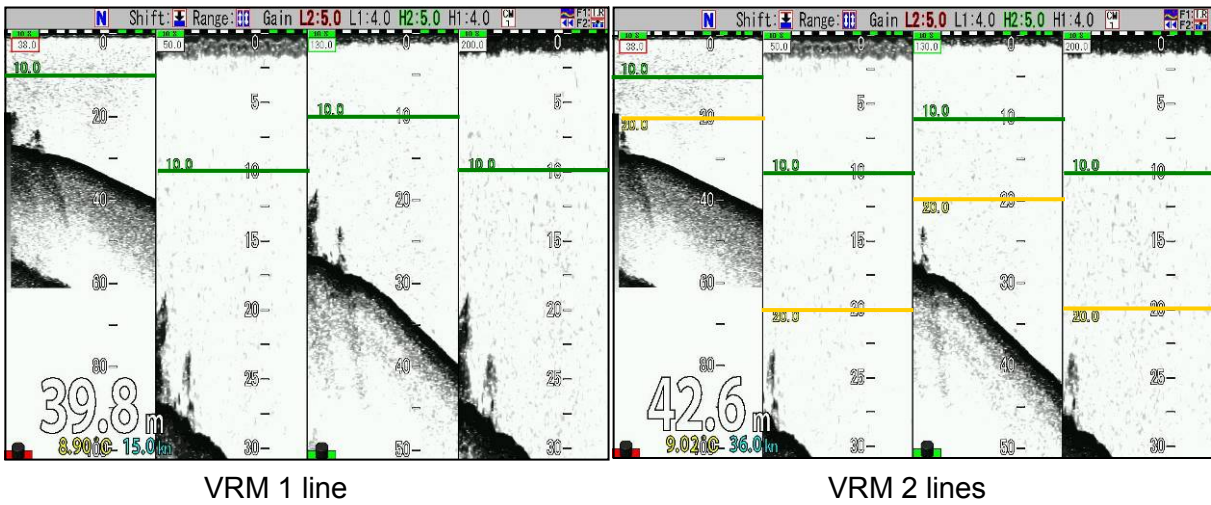

### 2.4.1 Changing of VRM follow interval

Under the first VRM, another VRM with interval can be displayed. This VRM follows the movement of the first VRM keeping the interval, and this is intended to use as a guidance of depth for casting a net.

**To change the displayed interval of the second VRM:**

1. Press [MENU] key .

2. The menu is displayed. Move the cursor to [Display Setup 2] with [▲] or [▼] keys of .

Echo Adjust	Scale	ON
TVG	Scale Position	Side
Disp. Setup1	Scale Value	Large
<b>Disp. Setup2</b>	Color Bar Scale	ON
Range Setup	Image Title	Frequency
Shift Setup	Water Temp Window	OFF
BTM Search	W.Temp. Graph Range	5°C
Alarm1	Depth Font Size	Medium
Alarm2	Depth Position	Bottom
NAV	W.Temp. Font Size	Small
Image	Speed Value	ON
Manual Set	Detection Area	ON
	VRM Interval	0.0m
	VRM Image	Active Screen
	Return	

3. Press [▶] key of .



4. The menu [Disp. setup 2] is displayed. Move the cursor to [VRM Interval] with [▲] or [▼]

keys of  .

Echo Adjust	Scale	ON
TVG	Scale Position	Side
Disp. Setup1	Scale Value	Large
Disp. Setup2	Color Bar Scale	ON
Range Setup	Image Title	Frequency
Shift Setup	Water Temp Window	OFF
BTM Search	W.Temp. Graph Range	5°C
Alarm1	Depth Font Size	Medium
Alarm2	Depth Position	Bottom
NAV	W.Temp. Font Size	Small
Image	Speed Value	ON
Manual Set	Detection Area	ON
	<b>VRM Interval</b>	0.0m
	VRM Image	Active Screen
	Return	

5. Press [▶] key of  .

6. The menu [VRM Interval] is displayed. Set an interval by increasing or decreasing a

numeric value with [▲] or [▼] keys of  .



- With [◀] key, the digit can be moved to larger side.
- With [▶] key, the digit can be moved to smaller side.
- With [▲] key, the value increases.
- With [▼] key, the value decreases.





7. Press [MENU] key  , and the menu disappears and the selected VRM follow interval is set.

### 2.4.2 Operation of VRM in Active Screen

To switch VRM display to Active Screen:

1. Press [MENU] key .
2. The menu is displayed. Move the cursor to [Disp. Setup 2] with [▲] or [▼] keys of .

Echo Adjust	Scale	ON
TVG	Scale Position	Side
Disp. Setup1	Scale Value	Large
<b>Disp. Setup2</b>	Color Bar Scale	ON
Range Setup	Image Title	Frequency
Shift Setup	Water Temp Window	OFF
BTM Search	W.Temp. Graph Range	5°C
Alarm1	Depth Font Size	Medium
Alarm2	Depth Position	Bottom
NAV	W.Temp. Font Size	Small
Image	Speed Value	ON
Manual Set	Detection Area	ON
	VRM Interval	0.0m
	VRM Image	Active Screen
	Return	

3. Press [▶] key of .
4. The menu [Disp. Setup2] is displayed. Move the cursor to [VRM Image] with [▲] or [▼] keys of .

Echo Adjust	Scale	ON
TVG	Scale Position	Side
Disp. Setup1	Scale Value	Large
<b>Disp. Setup2</b>	Color Bar Scale	ON
Range Setup	Image Title	Frequency
Shift Setup	Water Temp Window	OFF
BTM Search	W.Temp. Graph Range	5°C
Alarm1	Depth Font Size	Medium
Alarm2	Depth Position	Bottom
NAV	W.Temp. Font Size	Small
Image	Speed Value	ON
Manual Set	Detection Area	ON
	VRM Interval	0.0m
	<b>VRM Image</b>	Active Screen
	Return	

5. Press [▶] key of .

6. The menu [VRM Image] is displayed. Move the cursor with [▲] or [▼] keys of , and select [Active Screen] and [All Screens].



7. Press [MENU] key , and the menu disappears and the selected VRM image is set.

### Operation of VRM:

#### To move VRM downward:

If [▼] of  is pressed, the line of VRM is highlighted with black edge and its value is displayed in double sized characters.

Keep pressing [▼], and VRM moves downward. The display of value is updated at the depth.

When the second VRM is displayed, the second VRM also moves simultaneously downward.

When it comes near the aimed position, release the key. And by pressing a few times, fine adjustment of the position can be done.

#### To move VRM upward:

If [▲] of  is pressed, the line of VRM is highlighted with black edge and its value is displayed in double sized characters.



Keep pressing [▲], and VRM moves upward. The display of value is updated at the depth.

When the second VRM is displayed, the second VRM also moves simultaneously upward.

When it comes near the aimed position, release the key. And by pressing a few times, fine adjustment of the position can be done.



#### To move VRM Image to Active Screen:

To select the left screen, press [GAIN-L/SEL]  and to select the right screen, press [GAIN-R/SEL] , and display  (red) blinking at the bottom of the screen to be operated.



 **Caution:** [Gain knob icon] at the bottom of screen changes to  (red) when gain setting is [Individual] and to  (red) when [Synchronized].

### 2.4.3 Operation of VRM on all Screens

To switch over VRM Image to All Screens:

1. Press [MENU] key .
2. The menu is displayed. Move the cursor to [Disp. Setup2] with [▲] or [▼] keys of .

Echo Adjust	Scale	ON
TVG	Scale Position	Side
Disp. Setup1	Scale Value	Large
<b>Disp. Setup2</b>	Color Bar Scale	ON
Range Setup	Image Title	Frequency
Shift Setup	Water Temp Window	OFF
BTM Search	W.Temp. Graph Range	5°C
Alarm1	Depth Font Size	Medium
Alarm2	Depth Position	Bottom
NAV	W.Temp. Font Size	Small
Image	Speed Value	ON
Manual Set	Detection Area	ON
	VRM Interval	0.0m
	VRM Image	Active Screen
	Return	

3. Press [▶] key of .
4. The menu [Disp. Setup2] is displayed. Move the cursor to [VRM Image] with [▲] or [▼] keys of .

Echo Adjust	Scale	ON
TVG	Scale Position	Side
Disp. Setup1	Scale Value	Large
<b>Disp. Setup2</b>	Color Bar Scale	ON
Range Setup	Image Title	Frequency
Shift Setup	Water Temp Window	OFF
BTM Search	W.Temp. Graph Range	5°C
Alarm1	Depth Font Size	Medium
Alarm2	Depth Position	Bottom
NAV	W.Temp. Font Size	Small
Image	Speed Value	ON
Manual Set	Detection Area	ON
	VRM Interval	0.0m
	<b>VRM Image</b>	Active Screen
	Return	

5. Press [▶] key of .

6. The menu [VRM Image] is displayed. Select [Active Screen] [All Screens] by moving the cursor with [▲] or [▼] keys of .

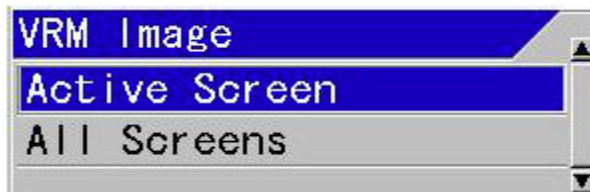

7. Press [MENU] key , and the menu disappears and the selected VRM Image is set.

#### Operation of VRM:

##### To move VRM of [All Screens] downward:

Press [▼] of , and the line of VRM is highlighted with black edge and VRM value is indicated in double sized characters.

Keep pressing [▼] key, and VRM moves downward. The display of value is updated at the depth.

When the second VRM is displayed, the second VRM also moves simultaneously downward. When it comes near the aimed position, release the key. And by pressing a few times, fine adjustment of the position can be done.

##### To move VRM of [All Screens] upward:

Press [▲] of , and the line of VRM is highlighted with black edge and VRM value is indicated in double sized characters.

Keep pressing [▲] key, VRM moves upward. The display of value is updated at the depth.

When the second VRM is displayed, the second VRM also moves simultaneously upward. When it comes near the aimed position, release the key. And by pressing a few times, fine adjustment of the position can be done.





**Caution:** At [All Screens Same (range)] and [All Screens Same (shift)], VRM on all screens moves simultaneously. At [Scr. Individual (range)] and [Scr. Individual (shift)], VRM individually moves per Active Screen.

To move VRM Image to an active screen at [Screen individual range]/[Screen individual shift],

to select the left screen, press [GAIN-L/SEL]  and to select the right screen, press [GAIN-R/SEL] , to display  (red) blinking at the bottom of the screen to be operated.



**Caution:** [Gain knob icon] at the bottom of screen changes to  (red) when gain setting is [Individual] and to  (red) when [Synchronized].

## 2.5 Reduction of noise on images

Images of echo sounders display noise due to various causes.

The causes of noise are:

1. Interference caused by reception of signals transmitted by other echo sounders
2. Blur due to micro animate beings such as plankton
3. Noise caused by electric signal synchronized with transceiver

JFC-180BB is equipped with functions to weaken the effect by each cause.

### 2.5.1 To reject interference

Interference is generated by the reception of signals transmitted by other echo sounders.

JFC-180BB can eliminate interference by the following two methods:

1. To shift your own frequency from the frequency used by other echo sounders, to avoid reception of interference wave.
2. To reject interference by setting [IR (Interference Rejection) ] function.

<Example of IR (Interference Rejection) images>

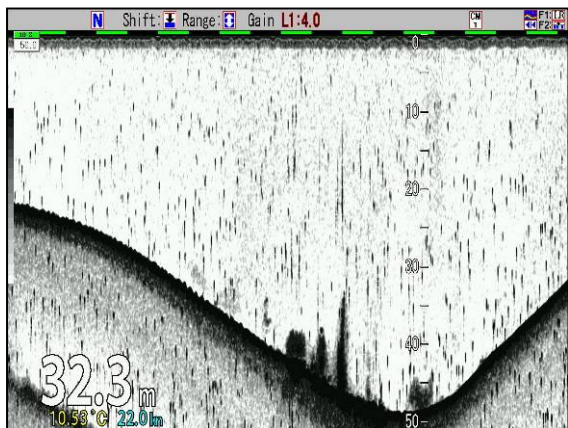

Image with interference

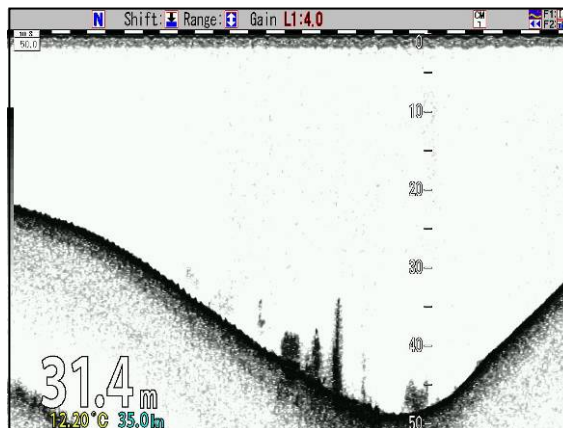

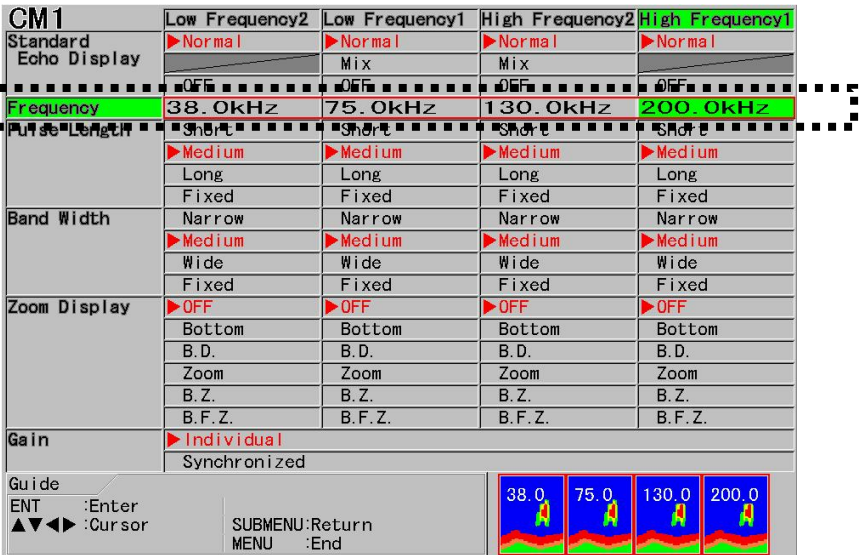

Image after rejection of interference

**To avoid the reception of interference wave by shifting your own frequency:**



1. Press the CM key used (lights red [CM] key).  
Press the [CM1] key  when CM1 is lit red.
2. CM menu is displayed.
3. Move the cursor to the position of the frequency to be shifted in the frequency display items with  .

Frequency item

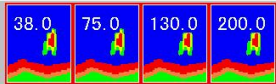

CM1	Low Frequency2	Low Frequency1	High Frequency2	High Frequency1
Standard	▶Normal	▶Normal	▶Normal	▶Normal
Echo Display	OFF	Mix	Mix	OFF
Frequency	38.0kHz	75.0kHz	130.0kHz	200.0kHz
Pulse Length	Short	Short	Short	Short
	▶Medium	▶Medium	▶Medium	▶Medium
	Long	Long	Long	Long
	Fixed	Fixed	Fixed	Fixed
Band Width	Narrow	Narrow	Narrow	Narrow
	▶Medium	▶Medium	▶Medium	▶Medium
	Wide	Wide	Wide	Wide
	Fixed	Fixed	Fixed	Fixed
Zoom Display	▶OFF	▶OFF	▶OFF	▶OFF
	Bottom	Bottom	Bottom	Bottom
	B.D.	B.D.	B.D.	B.D.
	Zoom	Zoom	Zoom	Zoom
	B.Z.	B.Z.	B.Z.	B.Z.
	B.F.Z.	B.F.Z.	B.F.Z.	B.F.Z.
Gain	▶Individual			
	Synchronized			
Guide	ENT :Enter ▲▼◀▶ :Cursor SUBMENU:Return MENU :End			



4. Press [ENT] key  .
5. [Frequency] change box is displayed.
6. By increasing or decreasing the numeric value with [▲] or [▼] of  , the frequency is set.

With [▲] key, the value increases.  
With [▼] key, the value decreases.

Keep pressing the key, and the digit carries up automatically.

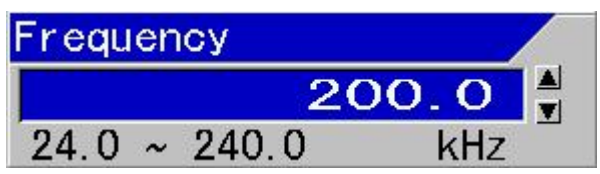

Frequency

200.0

24.0 ~ 240.0 kHz

If the frequency is shifted by approximately 10 kHz, interference wave would not be received.

7. Adjust by viewing image, and press [ENT] key  when interference disappears.

### To setup [IR] (Interference Rejection) function and to eliminate interference wave:

There are 3 steps of setting: [OFF], [Low] and [High] for interference rejection function.

If interference does not disappear at the set of [Low], then the set change the setting to [High].

The interference rejection is set stronger from [Low] to [High], interference rejection effect is stronger, but with more deterioration of images. Image of fast moving individual fish, etc. is harder to be detected in the stronger setting.

1. Press [MENU] key .

2. The menu is displayed. Move the cursor to [Echo Adjust] with [ $\blacktriangle$ ] or [ $\blacktriangledown$ ] keys of .

Echo Adjust	IR	High
TVG	Random Transmission	2
Disp. Setup1	Color Erase	0%
Disp. Setup2	Noise Reduction	0
Range Setup	TX Power (HF)	20
Shift Setup	TX Power (LF)	20
BTM Search	Dynamic Range HF1	24
Alarm1	Dynamic Range HF2	24
Alarm2	Dynamic Range LF1	24
NAV	Dynamic Range LF2	24
Image	Background Color	Dark Blue
Manual Set	Color Tone	64 Color
	Return	

3. Press [ $\blacktriangleright$ ] key of .

4. The menu [Echo Adjust] is displayed. Point the cursor to [IR] with [ $\blacktriangle$ ] or [ $\blacktriangledown$ ] keys of .

Echo Adjust	IR	High
TVG	Random Transmission	2
Disp. Setup1	Color Erase	0%
Disp. Setup2	Noise Reduction	0
Range Setup	TX Power (HF)	20
Shift Setup	TX Power (LF)	20
BTM Search	Dynamic Range HF1	24
Alarm1	Dynamic Range HF2	24
Alarm2	Dynamic Range LF1	24
NAV	Dynamic Range LF2	24
Image	Background Color	Dark Blue
Manual Set	Color Tone	64 Color
	Return	

5. Press [ $\blacktriangleright$ ] key of .



6. The menu [IR] is displayed. Select [Low] with [▲] or [▼] of .

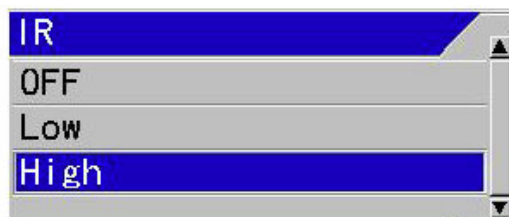

7. By viewing images, confirm that interference has disappeared.

8. If not, select [High] with [▲] or [▼] keys of .

9. Press [MENU] key , and the menu disappears.

### When [Random Transmission] is effective (The image speed slows)

To reduce noise like a ghost image by synchronized phenomenon, a random transmission is effective. However, the image speed goes slow because the transmission timing is delayed at random.

When [Random Transmission] is [2], the transmission delays from 0 to 90% at random compared with [OFF]. Therefore the image speed goes about twice as slow compared with [OFF].

When [Random Transmission] is [1], the transmission delays from 0 to 50% at random compared with [OFF]. Therefore the image speed goes about 1.5 times slower compared with [OFF].

When [Random Transmission] is [OFF], there is no delay at the image speed because it doesn't transmit at random. However, the ghost image might be appeared due to synchronized phenomenon by an interference of another equipment.

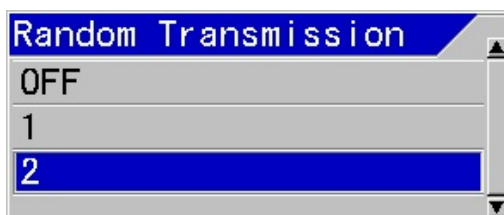

**Caution:** When [IR] is [OFF], [Random Transmission] is disabled.

### 2.5.2 To erase the weak response from dust and plankton, etc.

To erase the weak response from dust and microbes such as plankton in seawater, there are following 4 methods:

1. Setting TVG
2. Shortening pulse length and narrowing frequency bandwidth
3. Setting [Color Erase] function
4. Setting [IR] (Interference rejection) function

#### When TVG is effective:

In order to erase the response from dust and plankton at shallow depth of the displayed screen, setting TVG is effective.

TVG can be set in two ways, [Optimized TVG] and [Manual TVG].

In the case of setting in [Optimized TVG], the images are clear with less interference noise down to water depth of approximately 100 m.

As for the setting of [Optimized TVG], see "To use of optimized TVG", p 2 - 57.

By setting [Manual TVG], noise reduction setting is possible to preference.

As for the setup of [Manual TVG], see "To adjust with manual TVG", p 2 - 60.

#### When shortening pulse length and narrowing frequency bandwidth are effective:

When the range used is less than 100 m and the response from dust and plankton on whole screen is to be erased, it would be effective to set the pulse length at [Short] and the frequency bandwidth at [Narrow].

By this setting, fine images such as dust and plankton are erased.

It can be used for highlighting of images of aimed fish and erasing of response smaller than those.

As for the setup of [Pulse Length], see "2.1.5 Selection of pulse length", p 2 - 19.

As for the setup of [Frequency Bandwidth], see "2.1.6 Selection of frequency bandwidth", p 2 - 22.

#### When [Color Erase] is effective:

When the response from dust and plankton displayed in light bluish color is to be erased, it is effective to use [Color Erase] function.

The response of dust and plankton displayed in stronger color than green could not be erased.

The color of aimed fish images and appearance of expanding response are displayed as it is and unnecessary response from dust and plankton is erased.

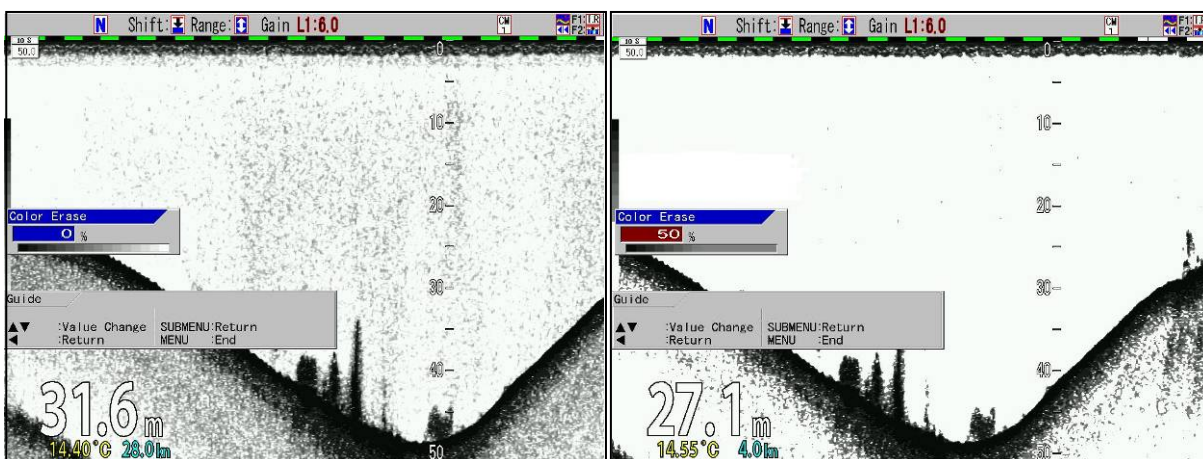

<Example of images with color erasing>



Color erase 0 %

Color erase 50 %

**To set [Color Erase]:**

1. Press [MENU] key .
2. The menu is displayed. Move the cursor to [Echo Adjust] with [▲] or [▼] of .

Echo Adjust	IR	High
TVG	Random Transmission	2
Disp. Setup1	Color Erase	0%
Disp. Setup2	Noise Reduction	0
Range Setup	TX Power (HF)	20
Shift Setup	TX Power (LF)	20
BTM Search	Dynamic Range HF1	24
Alarm1	Dynamic Range HF2	24
Alarm2	Dynamic Range LF1	24
NAV	Dynamic Range LF2	24
Image	Background Color	Dark Blue
Manual Set	Color Tone	64 Color
	Return	

3. Press [▶] key of .

4. The menu [Echo Adjust] is displayed. Move the cursor to [Color Erase] with [▲] or [▼] keys of .

Echo Adjust	IR	High
TVG	Random Transmission	2
Disp. Setup1	<b>Color Erase</b>	0%
Disp. Setup2	Noise Reduction	0
Range Setup	TX Power (HF)	20
Shift Setup	TX Power (LF)	20
BTM Search	Dynamic Range HF1	24
Alarm1	Dynamic Range HF2	24
Alarm2	Dynamic Range LF1	24
NAV	Dynamic Range LF2	24
Image	Background Color	Dark Blue
Manual Set	Color Tone	64 Color
	Return	

5. Press [▶] key of .

6. The menu of [Color Erase] is displayed. Adjust [%] with [▲] or [▼] keys of .

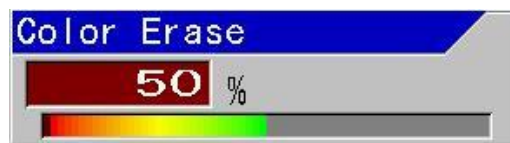
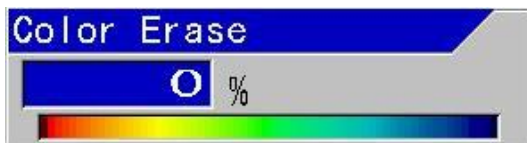

With [▲] key, [%] increases (Bluish color first disappears first).

With [▼] key, [%] decreases (Disappeared color comes out).

Adjustment can be performed within a range from 0 % to 50 %.

At 50 %, color from blue to mint green disappears.

Displayed color can be confirmed with the [Color Bar Scale] in the [Color Erase] box and the color bar scale at edge of screen.

7. Press [MENU] key , and the menu disappears.

**When [Noise Reduction] is effective:**

When the response from dust and plankton is to be diminished regardless of water depth and color, [Noise Reduction] is effective.

For [Noise Reduction] function, by narrowing the dynamic range and reducing tone graduation of colors, the color of weak response level becomes less visible.

<Example of Noise Reduction images>

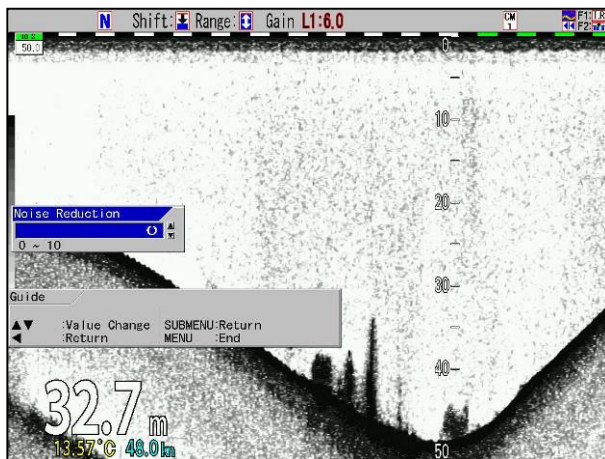

Noise Reduction 0

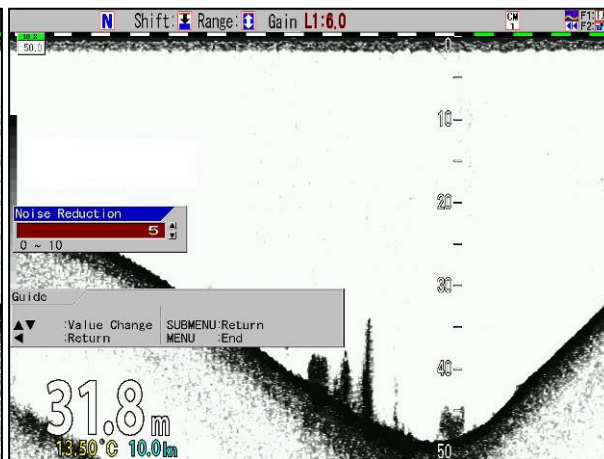

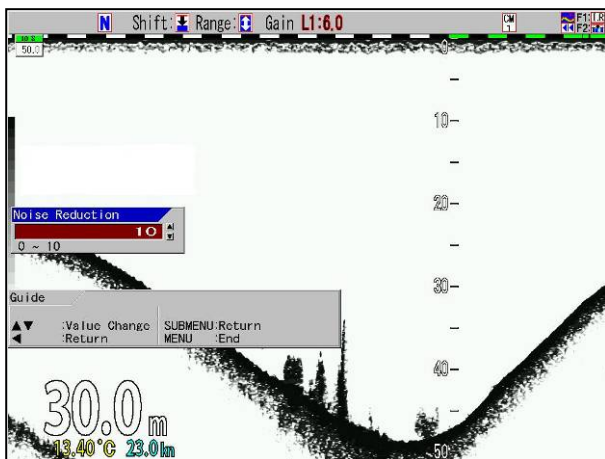

Noise Reduction 5



Noise Reduction 10

**To set [Noise Reduction]:**

1. Press [MENU] key .
2. The menu is displayed. Move the cursor to [Echo Adjust] with [▲] or [▼] keys of .

<b>Echo Adjust</b>	IR	High
TVG	Random Transmission	2
Disp. Setup1	Color Erase	0%
Disp. Setup2	Noise Reduction	0
Range Setup	TX Power (HF)	20
Shift Setup	TX Power (LF)	20
BTM Search	Dynamic Range HF1	24
Alarm1	Dynamic Range HF2	24
Alarm2	Dynamic Range LF1	24
NAV	Dynamic Range LF2	24
Image	Background Color	Dark Blue
Manual Set	Color Tone	64 Color
	Return	

3. Press [▶] key of .

4. The menu [Echo Adjust] is displayed. Move the cursor to [Noise Reduction] with [▲] or [▼] keys of .

<b>Echo Adjust</b>	IR	High
TVG	Random Transmission	2
Disp. Setup1	Color Erase	0%
Disp. Setup2	<b>Noise Reduction</b>	0
Range Setup	TX Power (HF)	20
Shift Setup	TX Power (LF)	20
BTM Search	Dynamic Range HF1	24
Alarm1	Dynamic Range HF2	24
Alarm2	Dynamic Range LF1	24
NAV	Dynamic Range LF2	24
Image	Background Color	Dark Blue
Manual Set	Color Tone	64 Color
	Return	

5. Press [▶] key of .

6. The menu [Noise Reduction] is displayed. Adjust the value with [▲] or [▼] keys of .

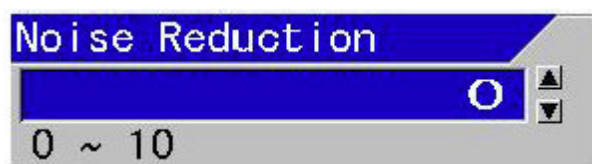

With [▲] key, the value increases.  
With [▼] key, the value decreases.

The bigger the value becomes, the more effective Noise Reduction becomes.

7. Press [MENU] key , and the menu disappears.

### 2.5.3 To reduce noise

JFC-180BB is equipped with the [Noise Reduction] function.

For [Noise Reduction] function, by narrowing the dynamic range and reducing tone graduation of colors, the color of weak response level becomes less visible.

As for the setup of [Noise Reduction], see “To set [Noise Reduction]”, p 2 – 84.





## Chapter 3 To make the best of [CM] keys

### 3.1 To use [CM] keys

[CM] (Condition Memory) key is used to **memorize setting conditions of an echo sounder and recall them with one touch of a key button**. For example, it is possible to switch the setting for seine fishing to the setting of squid fishing with one touch of a key button. JFC-180BB is equipped with six [CM] keys, so can be used as if six units of echo sounders were used at a time.

[CM] key has three major functionality:

- Switching screen mode
- Switching all settings with one touch of a button (setting values for each fishing method can be memorized, recalled and switched with one touch of a button)
- Usually it is used for switching screen modes, and when the type of fishing is changed, a particular setting can be switched to the other setting with one touch of a button, if specific values are memorized.

Please proceed to the corresponding pages for the functionality of your interest.

◆ To use as a switching key of screen modes:

Types of screen (4-frequency, 2-frequency, Single-frequency, Zoom) are switched over frequently.

Settings of menu, shift and gain, etc. are not decided.

Please proceed to “3.1.1 To use [CM] key for switching screen modes”, p 3-2.

◆ To use as one touch switching key of all settings

Types of screen are rarely changed.

Settings of menu, range, shift and gain, etc. have been determined by fishing methods, and all settings should be changed at once when fishing method is changed.

Please proceed to “3.1.2 To use [CM] keys as one touch switch to memorized setting to the fishing positions”, p 3-6.

◆ Usually the key is used for switching screen modes, and when fishing method is changed, it is used as one touch switching key.

Types of screen (4-frequency, 2-frequency, Single-frequency, Zoom) are switched over frequently.

Type of screen, menu setup, range, shift and gain, etc. have been determined by fishing methods, and all settings should be changed at once when fishing method is changed.

Please proceed to “3.1.3 Use [CM] keys as screen mode switch and one touch switch of setting”, p 3-10.

**3.1.1 To use [CM] key for switching screen modes**

JFC-180BB is not equipped with the switching knobs or dedicated keys for screen modes like conventional echo sounders. Instead, 6 types of screen modes\*<sup>1</sup> can be memorized with 6 keys of CM1 to CM6.

By pressing each key of CM1 to CM6 ([CM] key lit green), and the screen mode turns to the setting mode (Color of light turns red).

Screen modes (Normal screen, Zoom screen, 4-frequency, 2-frequency, single frequency, etc.) are switched. The setting values of range, shift, gain and pulse length, etc. do not change.

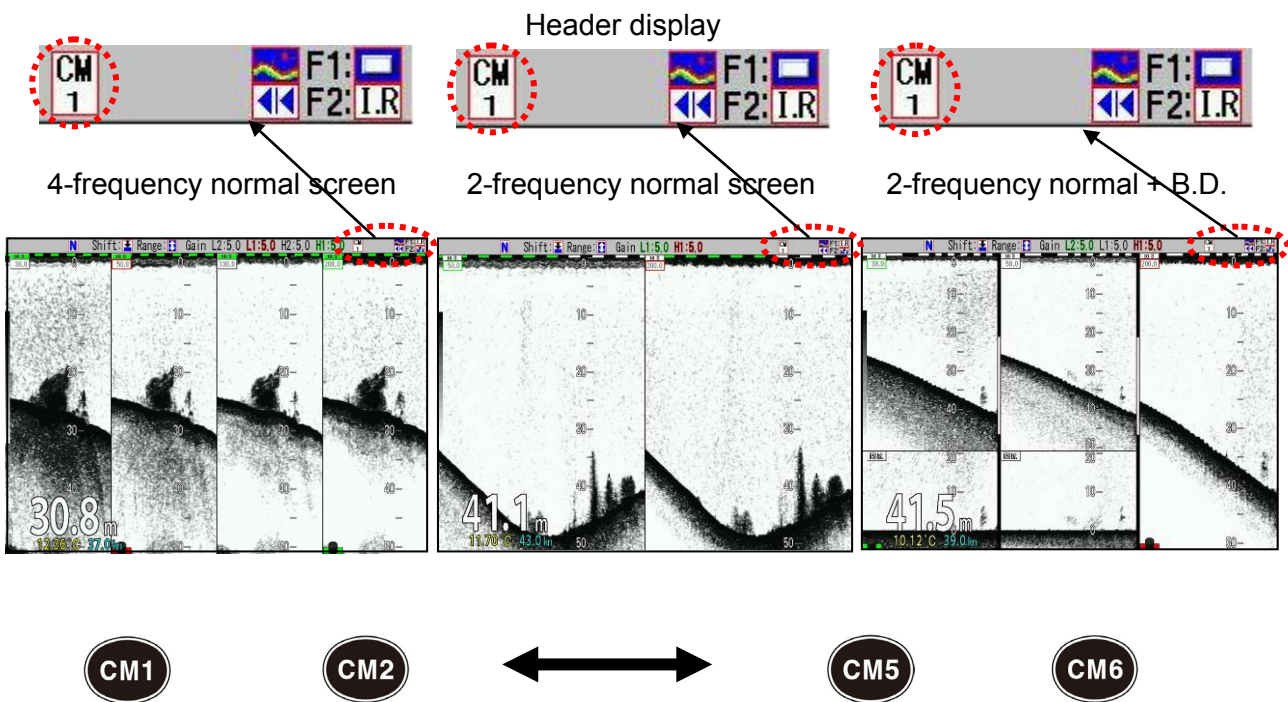

The CM number in the header display does not change even when switching the [CM] key, to indicate the CM number selected before the [CM] key was set to [Screen mode switching]

When CM1 is displayed, CM1 remains as it is.





\*<sup>1</sup> As for the displayed content in screen mode, see “2.1 Switch screen images (Setting of CM menu)”, p 2 -1

**To set [CM] key to [Screen mode switching]:**

1. Press [SUBMENU] key  .
2. The SUBMENU is displayed. Move the cursor to [System] with [▲] or [▼] keys of  .

<b>System</b>	Event Key Usage	Store Image
Source	FUNC1.Key Setting	Image Title
NMEA 1	FUNC2.Key Setting	IR
NMEA 2	Guide Window	ON
Correct	Func. Guide Window	ON
Heaving	Header Display	ON
TD Setting	Simple Menu	OFF
Basics	CM Key Usage	CM
Customize	Gain Type	Retractive Gain
Maintain	Bubble	OFF
Network	Clock Display	OFF
	Return	

3. Press [▶] of  .

4. The SUBMENU [System] is displayed. Move the cursor to [CM Key Usage] with [▲] or [▼] keys of  .

System	Event Key Usage	Store Image
Source	FUNC1.Key Setting	Image Title
NMEA 1	FUNC2.Key Setting	IR
NMEA 2	Guide Window	ON
Correct	Func. Guide Window	ON
Heaving	Header Display	ON
TD Setting	Simple Menu	OFF
Basics	<b>CM Key Usage</b>	CM
Customize	Gain Type	Retractive Gain
Maintain	Bubble	OFF
Network	Clock Display	OFF
	Return	

5. Press [▶] of .

6. The SUBMENU [CM Key Usage] is displayed. Move the cursor to [Screen Mode] with [▲] or [▼] keys of .

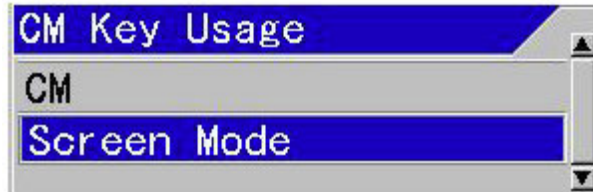

7. Press [MENU] key , the SUBMENU disappears and CM key is set at [Screen Mode Switching].

**To set screen mode per CM key:**

1. Press the CM key at which a screen mode is to be set.
2. Press again the same [CM] key (lit red).

In case of CM1, press [CM1] key .

3. The CM Menu is displayed.

4. Select display of normal images. Move the cursor with  to select [Normal] and [OFF] for high frequency 1 in the standard echo display items.

Standard Echo Display items

CM1	Low Frequency2	Low Frequency1	High Frequency2	High Frequency1
Standard Echo Display	▶Normal	▶Normal	▶Normal	▶Normal
	Mix	Mix	Mix	Mix
	OFF	OFF	OFF	OFF
Frequency	38.0KHZ	75.0KHZ	130.0KHZ	200.0KHZ
Pulse Length	Short	Short	Short	Short
	▶Medium	▶Medium	▶Medium	▶Medium
	Long	Long	Long	Long
	Fixed	Fixed	Fixed	Fixed
Band Width	Narrow	Narrow	Narrow	Narrow
	▶Medium	▶Medium	▶Medium	▶Medium
	Wide	Wide	Wide	Wide
	Fixed	Fixed	Fixed	Fixed
Zoom Display	▶OFF	▶OFF	▶OFF	▶OFF
	Bottom	Bottom	Bottom	Bottom
	B.D.	B.D.	B.D.	B.D.
	Zoom	Zoom	Zoom	Zoom
	B.Z.	B.Z.	B.Z.	B.Z.
	B.F.Z.	B.F.Z.	B.F.Z.	B.F.Z.
Gain	▶Individual			
	Synchronized			
Guide	ENT :Enter			38.0
	▲▼▶◀:Cursor			75.0
	SUBMENU:Return	130.0		200.0
	MENU :End			



5. Press [ENT] key .

6. For selection of Standard Echo Display of high frequency 2, low frequency 1 and low frequency 2, repeat the procedures 4 and 5.

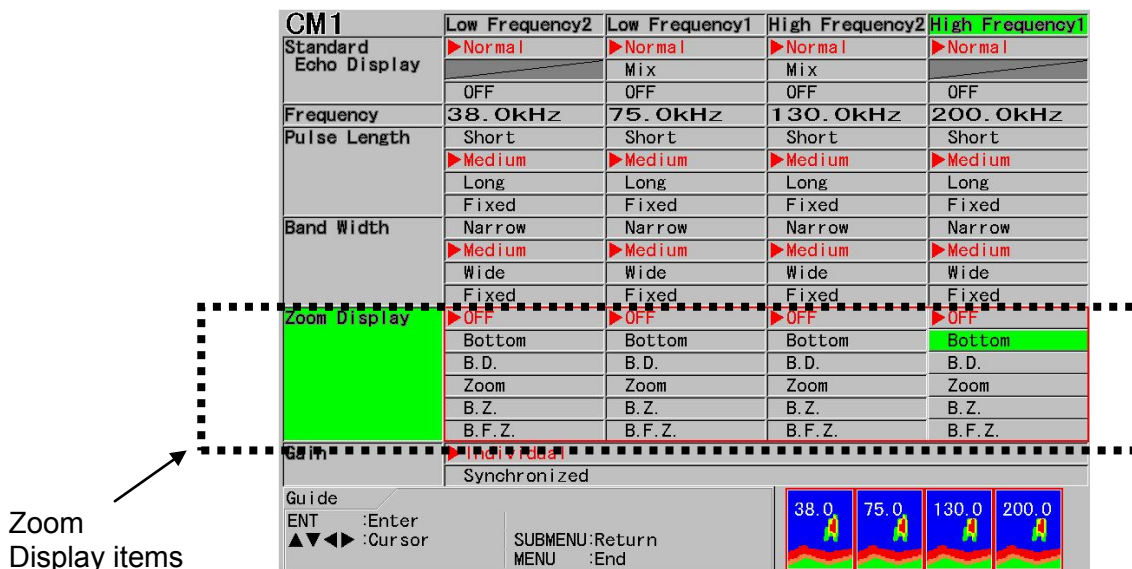
7. Select Zoom Display. Move the cursor with  to select [OFF], [Bottom], [B.D.], [Zoom], [B.Z.] and [B.F.Z.] for high frequency 1 in the Zoom Display items.



CM1	Low Frequency2	Low Frequency1	High Frequency2	High Frequency1
Standard Echo Display	▶Normal	▶Normal	▶Normal	▶Normal
	Mix	Mix	Mix	Mix
	OFF	OFF	OFF	OFF
Frequency	38.0kHz	75.0kHz	130.0kHz	200.0kHz
Pulse Length	Short	Short	Short	Short
	▶Medium	▶Medium	▶Medium	▶Medium
	Long	Long	Long	Long
	Fixed	Fixed	Fixed	Fixed
Band Width	Narrow	Narrow	Narrow	Narrow
	▶Medium	▶Medium	▶Medium	▶Medium
	Wide	Wide	Wide	Wide
	Fixed	Fixed	Fixed	Fixed
Zoom Display	▶OFF	▶OFF	▶OFF	▶OFF
	Bottom	Bottom	Bottom	Bottom
	B.D.	B.D.	B.D.	B.D.
	Zoom	Zoom	Zoom	Zoom
	B.Z.	B.Z.	B.Z.	B.Z.
	B.F.Z.	B.F.Z.	B.F.Z.	B.F.Z.
Gain	▶Indiv	▶Auto		
	Synchronized			
Guide				
ENT	:Enter			
▲▼◀▶	:Cursor			
	SUBMENU:Return			
	MENU :End			

8. Press [ENT] key .
9. For selection of Zoom Display of high frequency 2, low frequency 1 and low frequency 2, repeat the procedures 7 and 8.
10. Press [CM] key , and the CM menu ([CM] key lit red) disappears.
11. Set CM 2 to CM6 keys in the same way.

**3.1.2 To use [CM] keys as one touch switch to the memorized setting to the fishing positions**

When one of the CM1 to CM6 keys (CM key lit green) is pressed, screen mode, range, shift, gain, MENU set items and SUBMENU set items are switched over to the preset setting in the key (light color turns red).

**⚠ Caution:** [CM\*▶▶▶CM\*] is displayed for a few seconds, during the time until setting is switched after [CM] key is pressed.

Usually, settings of range, shift and gain value position are changed depending on fishing conditions in shallow or deep water. Once settings are memorized in CM keys, settings can be recalled by one touch of a button.

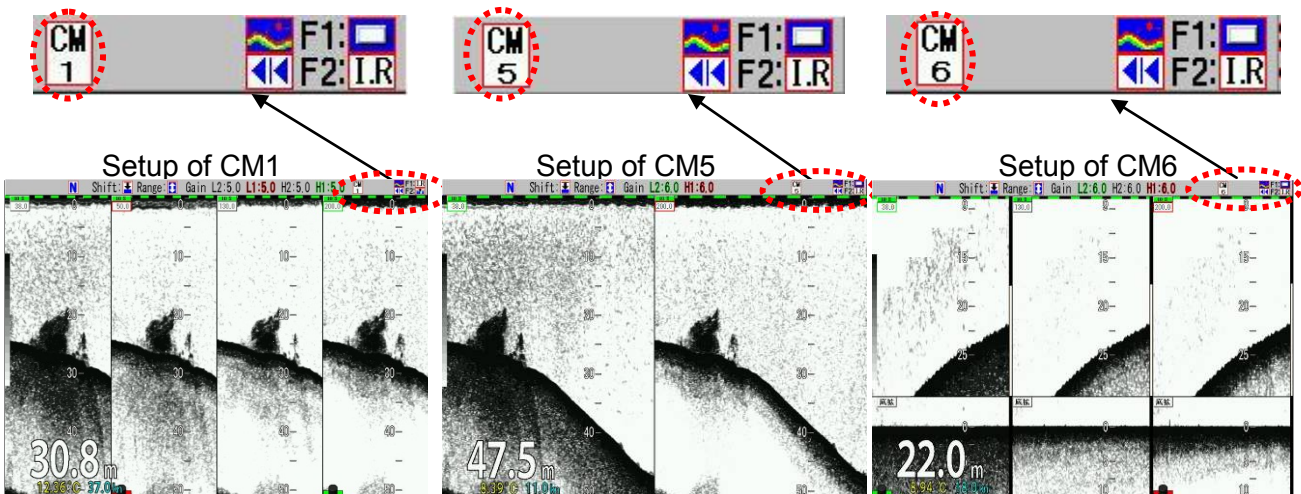

CM key function enables such switching as required, after saving maximum 6 different settings.

Header display indicates [CM] key number used.





The key of the same CM number as the CM number in the header display lights red.

**To set [CM] key to [One touch switch of setting] :**

1. Press [SUBMENU] key  .
2. The SUBMENU is displayed. Move the cursor to [System] with [▲] or [▼] of  .

<b>System</b>	Event Key Usage	Store Image
Source	FUNC1.Key Setting	Image Title
NMEA 1	FUNC2.Key Setting	IR
NMEA 2	Guide Window	ON
Correct	Func. Guide Window	ON
Heaving	Header Display	ON
TD Setting	Simple Menu	OFF
Basics	CM Key Usage	CM
Customize	Gain Type	Retractive Gain
Maintain	Bubble	OFF
Network	Clock Display	OFF
	Return	

3. Press [▶] of  .

4. The SUBMENU [System] is displayed. Move the cursor to [CM Key Usage] with [▲] or [▼] of  .

System	Event Key Usage	Store Image
Source	FUNC1.Key Setting	Image Title
NMEA 1	FUNC2.Key Setting	IR
NMEA 2	Guide Window	ON
Correct	Func. Guide Window	ON
Heaving	Header Display	ON
TD Setting	Simple Menu	OFF
Basics	<b>CM Key Usage</b>	CM
Customize	Gain Type	Retractive Gain
Maintain	Bubble	OFF
Network	Clock Display	OFF
	Return	

5. Press [▶] of .

6. The SUBMENU [CM Key Usage] is displayed. Move the cursor to [CM] with [▲] or [▼] of .

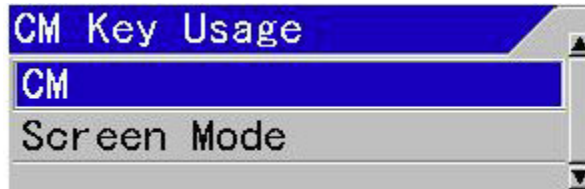

7. Press [MENU] key , and the SUBMENU disappears and the CM key is set to [Setup one touch switching].

#### To store in [CM] keys:

The present settings are stored in the [CM] key currently lit red.

There is no special operation necessary for storage.

Each time screen mode, range, shift, gain or setup of MENU, etc. is operated, the changes are stored in the [CM] keys lit red.

#### To store in a new [CM] key:

1. Press the [CM] key to which the settings to be stored (CM key lit green).

If the key is to be changed from CM1 to CM2, press [CM2] .

The key is now switched from CM1 to CM2 ([CM2] key turns from green to red), and the settings changes to the settings stored in CM2.

2. Each time screen mode, range, shift, gain or setting of menu, etc. is operated, the changes are stored in the [CM2] key lit red.

#### To store a new setting in another [CM] key based on a particular setting in a [CM] key:

The setting can be stored easily by copying operation.

1. The setting in the present [CM] key is copied in the [CM] key to be stored.

If new setting is to be stored in [CM2] key, based on the present setting in [CM1] key:

- Press [CM1] key .
- CM is switched over to CM1.







**Caution:** [CM\*▶▶▶▶CM\*] is displayed for a few seconds, during the time until setting is switched after [CM] key is pressed.



- Then, keep pressing the key [CM2]  until a guide of [Save setting to CM2] is indicated. [CM2] key blinks in red and green.



- Move the cursor to [Yes] with [ $\blacktriangle$ ] or [ $\blacktriangledown$ ] of .
- Press [ENT] key .
- The pop-up message of [The copy was completed to CM2] is displayed and copy of the setup in [CM1] to [CM2] key is complete.
- Press [CM2] key . CM1 is switched to [CM2].

 **Caution:** [CM\*▶▶▶CM\*] is displayed for a few seconds, during the time until setting is switched after [CM] key is pressed.

[CM2] key lights red.  
The setting of CM2 is the same as CM1.

- Each time screen mode, range, shift, gain or setup of MENU, etc. is operated, the changes are stored in the [CM2] key lit red.

 **Caution:** When [CM] key is used as [One touch switch of setting], pressing another [CM] key by mistake changes the setting. To prevent this, it is recommended to lock the [CM] key after switched to the intended setting by [CM] key. To lock the key, see the Instruction Manual [Advanced], "5.18 To lock the keys not to be operated".

#### About the settings not stored by [CM] key:

Only the items of "HF TD\*<sup>1</sup> Type" and "LF TD Type" in SUBMENU "TD Setting" are set in all CM keys commonly, not by each CM key.

\*<sup>1</sup> TD: Transducer

**3.1.3 Use [CM] keys as screen mode switching and one touch switch of setting:**

This is to use [CM] key as screen mode switching normally, and to change to one touch switch of setting when fishing method changes.

Per each [CM] key for one touch switch of setting, 6 types (CM1 to CM6) of screen mode can be set up.

Therefore, total 36 types of screen modes, 6 types per CM1 to CM6, can be stored.

**To store settings per fishing method in [CM] keys:**

1. Change [CM] keys to [One touch switch of setting]. Refer to “To set [CM] key to [One touch switch of setting]”, p 3-7 for details.

Change [CM Key Usage] to [CM].

The [CM] key with the same CM number as in the header display lights red.

2. Settings are stored in [CM] keys. Refer to “To store in [CM] keys”, “To store in a new [CM] key” and “To store a new setting in another [CM] key based on a particular setting in a [CM] key”, p 3-8 for details.

**To store screen mode in the setting of [CM] key per fishing method:**

1. Press the [CM] key in which screen mode to store. To store in CM1, press [CM1] key  . The header display turns to CM1.
2. Change [CM] key to [Screen mode switching]. Refer to “To set [CM] key to [Screen mode switching]”, p 3-3, [CM] key is changed to [Screen mode switching].
3. Store the screen mode in [CM1] to [CM6] keys, as described in “To set screen mode per CM key”, p 3-4, the screen mode is preset to [CM1] to [CM6] key. The CM number in the header display does not change. The [CM] key pressed lights red.
4. Store the screen mode in each CM key, by repeating procedures 1 and 2 above.

**To use [CM] keys normally as [Screen mode switching]:**

1. Press the [CM] key that is set as normal in use. In the case of CM1, press [CM1] .
2. Change [CM] key to [Screen mode switching] by referring to “To set [CM] key to [Screen mode switching]”, p 3-3.
3. Each time CM1, CM2, ••• CM6 is pressed, the screen mode switches.

**To recall the setting when fishing method changes:**

1. Change [CM] key to [One touch switch of setting] , by referring to “To set [CM] key to [One touch switch of setting]”, p 3-7.

Change [CM Key Usage] to [CM].

[CM] key with the same number as CM number in the header display lights.

2. Press the [CM] key that is set as normal in use. In the case of CM1, press [CM1] .

Each time CM1, CM2, ••• CM6 is pressed, the setting switches to the setting stored in the [CM] key pressed.



**Caution:** [CM\*▶▶▶CM\*] is displayed for a few seconds, during the time until setting is switched after [CM] key is pressed.



## Chapter 4 Useful operation

### 4.1 Temporary change of images for better view

In the images of echo sounders, normally such various information is overlaid as image title, water depth, water temperature, boat speed, color bar scale, alarm range bar, enlargement range bar. When the images are too busy with such information to see, the information can be temporarily deleted.

4

#### To delete image title, water depth, etc. temporarily

Press [ENT] key .



The display of image title, water depth etc. disappears and comes back on display after 5 seconds.

### 4.2 Use function keys ([F1]/[F2])

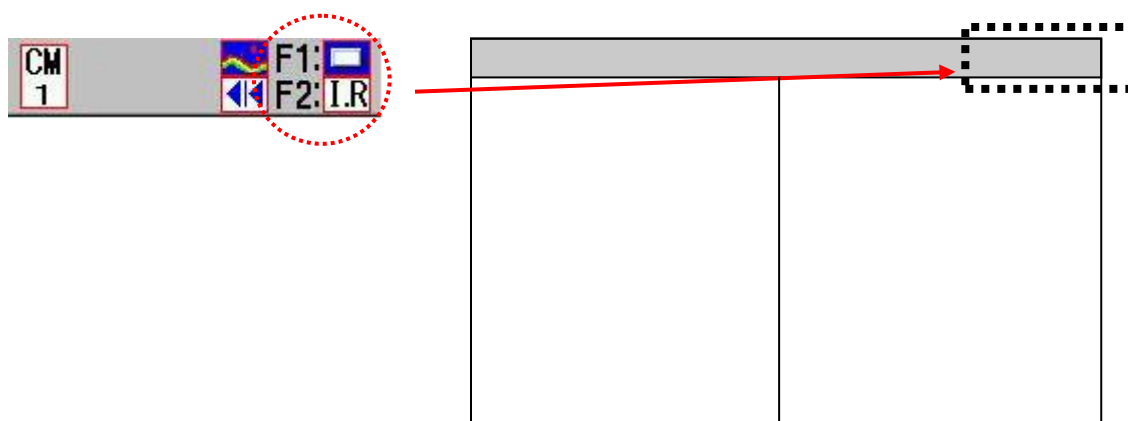
[F1]/[F2] keys can be assigned with the functions used frequently, to be operated with one touch operation. The icons for the assigned functions are displayed in the header display area.





















#### 4.2.1 To use function keys ([F1]/[F2])

1. Press [F1] key  or [F2] key .
2. The control box assigned to [F1]/[F2] is displayed.
3. Move the cursor with [▲] or [▼] keys of  to select items.
4. The control box automatically disappears 5 seconds after release of the key.



The control box can be also manually erased by pressing [MENU] key .

**4.2.2 Assign intended operation to function keys ([F1]/[F2])**

The functions can be assigned to [F1]/[F2]:

Icon	Function	Icon	Function
	: Shift Digit Input		: VRM Interval
	: IR (Interference rejection)		: Nav Start
	: Color Erase		: Image Recall
	: Noise Reduction		: Frequency
	: Background Color		: Event Key Usage
	: TVG Adjust		: Key Lock
	: White Line		: Depth Unit
	: A Scope		: Color Tone
	: Image Swap		: B.D. Mode
	: Image Title		

**To set functions to [F1]/[F2] keys:**

1. Keep pressing [F1] key  or [F2] key .
2. The [FUNC1./ FUNC2. Key Setting] box is displayed.

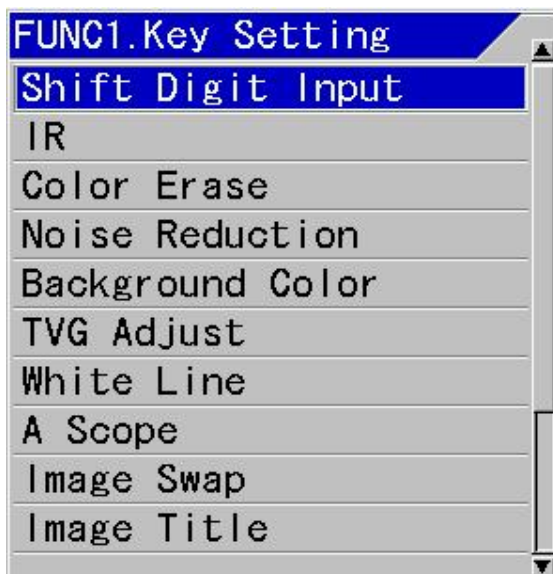

3. Move the cursor with [▲] or [▼] keys of  to select items.
4. The [FUNC1./ FUNC2. Key Setting] box automatically disappears 5 seconds after release of the key.

The control box can be also manually erased by pressing [MENU] key .

**4.3 Switching of range mode**

There are 3 types of range modes: [Auto Range], [Manual] and [Auto Shift].

[Auto Range] is the mode to switch the depth range automatically to display sea bottom always on the display screen.

[Manual] is the mode to switch the depth range manually by operation of the range key and shift by operation of the shift key.

[Auto Shift] is the mode to shift depth range automatically set to display sea bottom always on the display screen.

**4.3.1 Switch to manual operation**

To switch range mode to manual operation:

1. Keep pressing [SHIFT/M OFF] key  until [Range mode] menu is displayed.
2. Move the cursor with [▲] or [▼] keys of , and select [Manual].

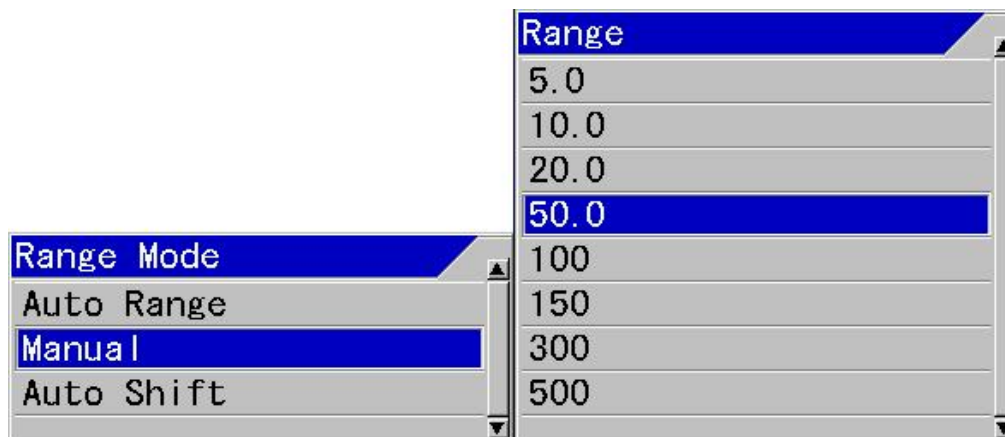

3. Press [ENT] key . Range mode is set at [Manual].

The header display showing range mode disappears, once set to [Manual].

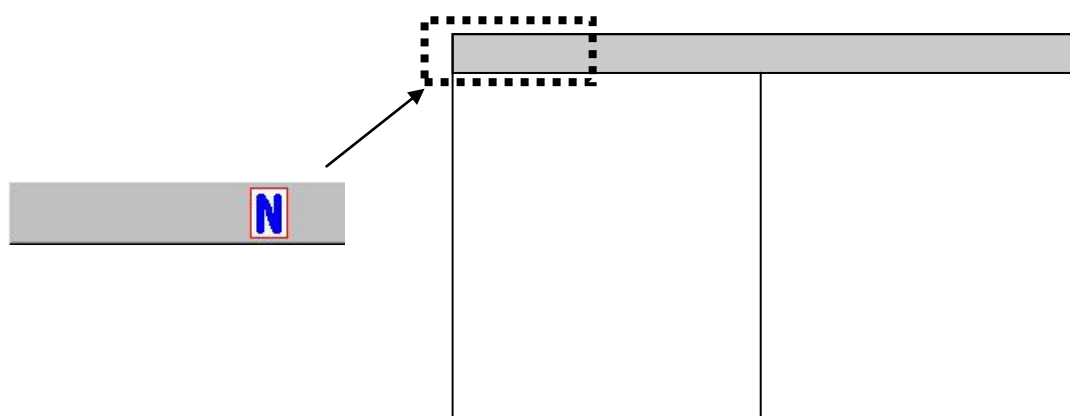

### 4.3.2 Setting of auto range

[Auto Range] is the function to switch depth range automatically to display sea bottom always on the displayed screen.

When sea bottom falls outside of the display screen, it turns to the sea bottom search mode with deeper range after a specific number of transmission (depending on the ranges, more frequent at shallower range and less frequent at deeper range).

The sea bottom search mode has a deep range to search sea bottom. Therefore, if sea bottom is not found quickly, a number of transmissions are done at the deep range and the cycle period of transmission becomes longer.

To reduce this deterioration of cycle period, there is a function to specify the maximum search range.

#### To switch depth range to auto range:

1. Keep pressed [SHIFT/M OFF] key  until [Range Mode] menu is displayed.
2. Move the cursor and select [Auto Range] with [▲] or [▼] keys of .



3. Press [ENT] key . Range mode is set to [Auto Range].

[Auto Range] is displayed in the header display for range mode, once set to [Auto Range].

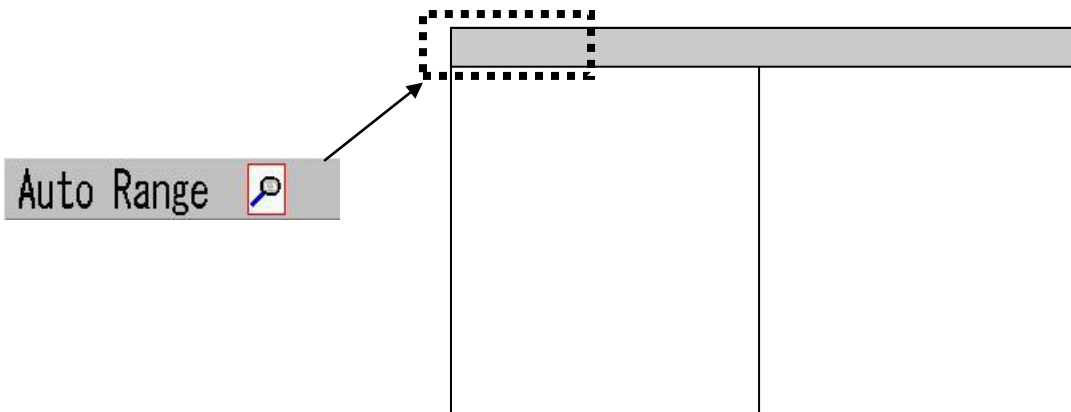



**Caution:** During the operation of auto range, [Range] and [Shift] keys are disabled. In addition, the range operation is set to [All Screen Same], and the [Scr. Individual] range and the [Scr. Individual] shift are not available either.



Function to specify the maximum search range so as to reduce deterioration of cycle period:

To set [Sounding Limit] at sea bottom search mode:

1. Press [MENU] key .
2. The menu is displayed. Move the cursor to [BTM Search] with [▲] or [▼] keys of .

Echo Adjust	Bottom Serch Range	Inside Range
TVG	Sounding Source	Auto Select
Disp. Setup1	Sounding Limit	4000m
Disp. Setup2	Return	
Range Setup		
Shift Setup		
<b>BTM Search</b>		
Alarm1		
Alarm2		
NAV		
Image		
Manual Set		

3. Press [▶] key of .

4. The menu [BTM Search] is displayed. Move the cursor to [Sounding Limit] with [▲] or [▼] keys of .

Echo Adjust	Bottom Serch Range	Inside Range
TVG	Sounding Source	Auto Select
Disp. Setup1	<b>Sounding Limit</b>	4000m
Disp. Setup2	Return	
Range Setup		
Shift Setup		
BTM Search		
Alarm1		
Alarm2		
NAV		
Image		
Manual Set		

5. Press [▶] key of .

6. The menu [Sounding Limit] is displayed. Adjust the depth by increasing/decreasing the value with [▲] or [▼] keys of .



- With [◀] key, the value moves to larger digit.
- With [▶] key, the value moves to smaller digit.
- With [▲] key, the value increases.
- With [▼] key, the value decreases.

7. Press [MENU] key , and the menu disappears.

### 4.3.3 Setting of auto shift

[Auto Shift] is the function to switch shift positions automatically to display sea bottom always on the displayed screen.

When sea bottom falls outside of the displayed screen, it turns temporarily to sea bottom search mode of Auto Range with deeper range after specific number of transmission (depending on the ranges, more frequent at shallower range and less frequent at deeper range).

Sea bottom search mode has a deep range to search sea bottom. Therefore, when sea bottom cannot be found quickly, a number of transmissions are done at the deep range and the cycle period of transmission becomes longer.

To reduce this deterioration of cycle period, there is a function to specify the maximum search range.

(See “4.3.2 Setting of auto range”)

#### To switch over Range Mode to Auto Shift:

1. Keep pressing [SHIFT/M OFF] key  until [Range Mode] menu is displayed.
2. Move the cursor and select [Auto Shift] with [▲] or [▼] keys of .

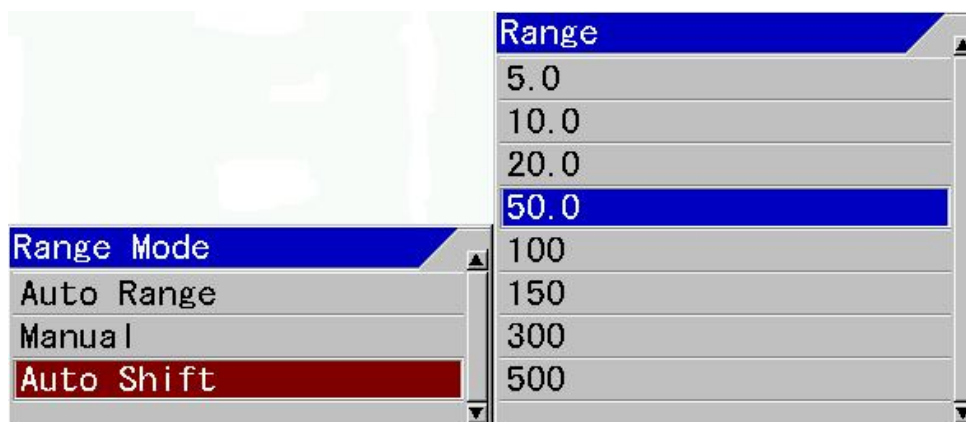

With [▲] or [▼] keys of [Range] , the range can be selected.

3. Press [ENT] key  . Range Mode is set at [Auto Shift].

When [Auto Shift] is set, [Auto Shift] is displayed in the header display showing Range Mode.

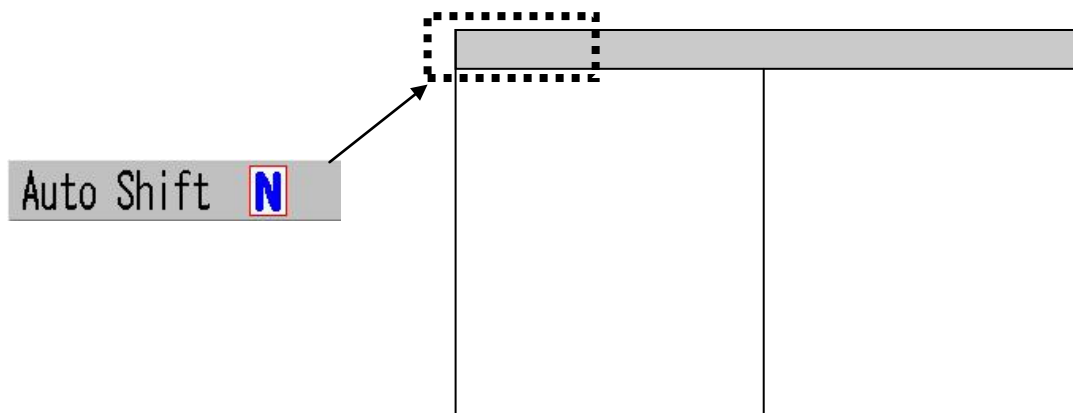



**Caution:** During the operation of auto shift, [Shift] key is disabled. In addition, the shift operation is set to [All Screen Same], and the [Scr. Individual] range and the [Scr. Individual] shift are not available either.

#### 4.4 To use event key

[Event] key  can be switched over among 3 functions: [Store Position] to register waypoints and to output the position information externally as TLL data, [Store Image] to store fish images as image files on screen, and [Homing] to assist return to the positions where events have been registered.



##### 4.4.1 Registration of waypoints

To enable [Store Position], it is necessary to input latitude/longitude data such as GGA, RMC and GLL of NMEA0183.

1. When [Event] key  is pressed, the position information input from outside is registered as waypoints.
2. A message box  is displayed and a red line is displayed on the screen.

 **Caution:** Maximum 10 waypoints can be registered. When there are more waypoints to be registered, please delete unnecessary waypoints. To delete waypoints, please see the Instruction Manual [Advanced]: “3.4 Deletion of waypoints” in “Chapter 3 NAV Operation”

##### 4.4.2 To store images

1. When [Event] key  is pressed, images are stored as bit-mapped files.  
During the storage operation, image scroll is stopped.
2. When storage is completed, a message box  is displayed and image scroll resumes.

 **Caution:** Maximum 500 images can be stored in the Image List. When there are more images to be stored, please delete unnecessary images. To delete images, please see the Instruction Manual [Advanced]: “4.3 Deleting of Image” and “4.4 Deletion of all images in the Image List” in “Chapter 4 Image List.”

To display the images stored images, see the Instruction Manual [Advanced]: “4.1 Recall of Image” in “Chapter 4 Image List”

**4.4.3 Starting up Homing**

To enable [Homing], it is necessary to input latitude/longitude data such as GGA, RMC and GLL of NMEA0183.

1. When [Event] key  is pressed, the position information input from outside is registered as waypoints, and the waypoint navigation starts taking the position information as waypoints.
2. NAV1 Screen is displayed.

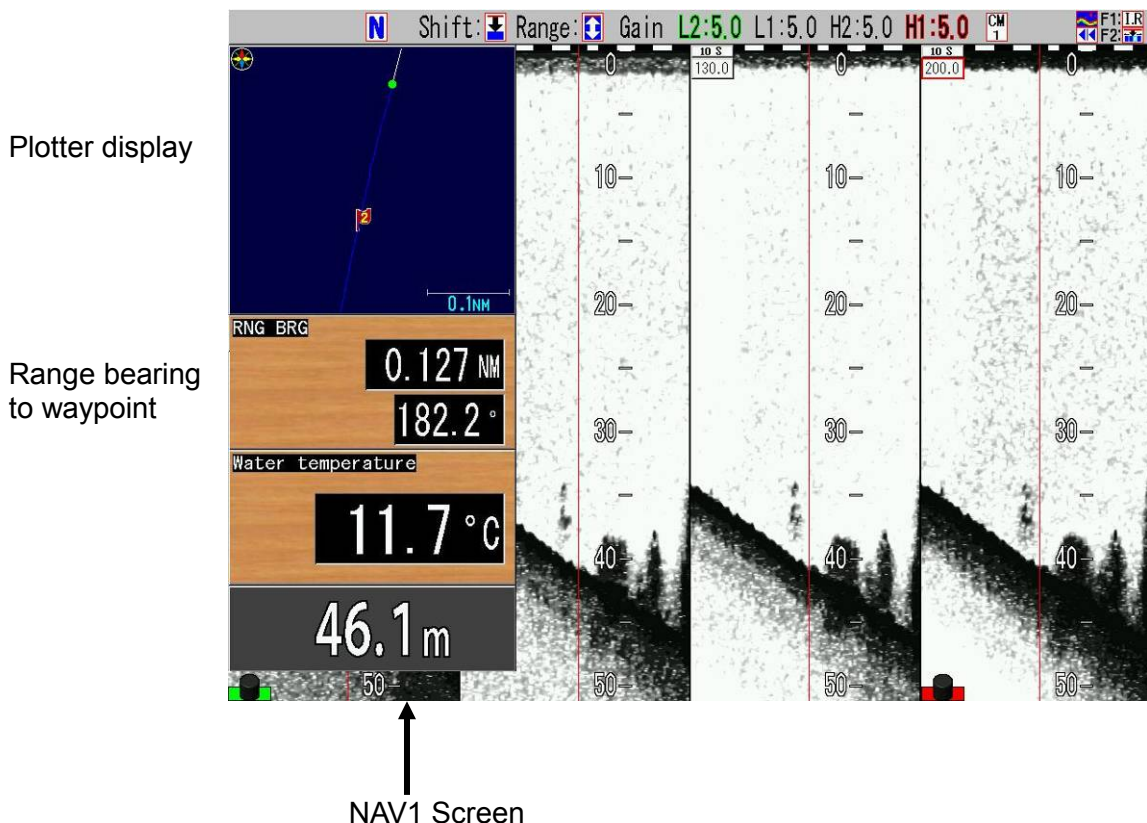

**! Caution:** After 10 waypoints are registered, no more points can be registered. When additional waypoint is to be registered, message box A Wpt list is full.  
Registration is not completed. appears.

In this case, waypoints are not registered and navigation calculation starts. If you want to register the waypoints, delete unnecessary waypoints. To delete waypoints, see the Instruction Manual [Advanced]: “3.4 Deletion of waypoints” in “Chapter 3 NAV Operation”.





#### 4.4.4 Selection of event key function

To select function of [Event] key:

1. Press [SUBMENU] key  .
2. The SUBMENU is displayed. Move the cursor to [System] with [ $\blacktriangle$ ] or [ $\blacktriangledown$ ] keys of  .

System	Event Key Usage	Store Image
Source	FUNC1.Key Setting	Image Title
NMEA 1	FUNC2.Key Setting	IR
NMEA 2	Guide Window	ON
Correct	Func. Guide Window	ON
Heaving	Header Display	ON
TD Setting	Simple Menu	OFF
Basics	CM Key Usage	CM
Customize	Gain Type	Retractive Gain
Maintain	Bubble	OFF
Network	Clock Display	OFF
	Return	

3. Press [ $\blacktriangleright$ ] of  .

4. The SUBMENU [System] is displayed. Move the cursor to [Event Key Usage] with [ $\blacktriangle$ ] or [ $\blacktriangledown$ ] keys of  .

System	Event Key Usage	Store Image
Source	FUNC1.Key Setting	Image Title
NMEA 1	FUNC2.Key Setting	IR
NMEA 2	Guide Window	ON
Correct	Func. Guide Window	ON
Heaving	Header Display	ON
TD Setting	Simple Menu	OFF
Basics	CM Key Usage	CM
Customize	Gain Type	Retractive Gain
Maintain	Bubble	OFF
Network	Clock Display	OFF
	Return	

5. Press [▶] of .

6. The SUBMENU [Event Key Usage] is displayed. Select a function to be set with [▲] or [▼] of .

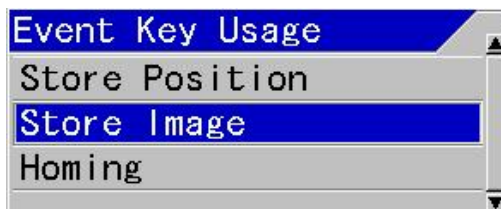

7. When [MENU] key  is pressed, the SUBMENU is closed and the selected function is set on the [Event] key.

#### 4.5 Shortcut to range registration menu



When the registered range in use is to be changed, there is a shortcut function to change the registered range directly with one touch operation not by menu operation.

**To change the Registered range in use by shortcut:**

1. Keep pressing [NORMAL/ZOOM] key  .
2. The menu [Range Setup] is displayed.

The cursor is located at the position of registered range currently in use.

Echo Adjust	Range Operation	All Screens Same
TVG	<b>Range1</b>	5.0m
Disp. Setup1	Range2	10.0m
Disp. Setup2	Range3	20.0m
Range Setup	Range4	50.0m
Shift Setup	Range5	100m
BTM Search	Range6	150m
Alarm1	Range7	300m
Alarm2	Range8	500m
NAV	Return	
Image		
Manual Set		

3. Press [▶] key of  .
4. The menu [Range X] is displayed. Set the range with [▲] or [▼] key of  .  
 With [▲] key, the value increases.  
 With [▼] key, the value decreases.

Keep pressing the key and the digit automatically shifts up.



Along the operation, the range on display changes to the range changed.

5. Press [Menu] key  to close the menu and registration of range is completed.



**4.6 To move the position of menu**

The MENU or SUBMENU is displayed half transparent at the upper left of the screen, overlaid on echo images.

There is a function to move the menu position, to see the echo images blocked by the display of MENU or SUBMENU.

**To move the display position of the MENU and the SUBMENU:**

1. While MENU or SUBMENU is on display, keep pressing [MENU] key .
2. The menu turns to menu moving mode, with a blip sound.

When Guide Window is displayed, the Guide Window switches to menu moving mode.

3. The MENU or SUBMENU can be moved upward and downward with [▲] or [▼] keys of .

The MENU or SUBMENU can be moved right and left with [◀] or [▶] keys.

4. When the position is determined, press [ENT] key .

Position moving mode of the MENU and the SUBMENU is completed. The changed position is memorized.

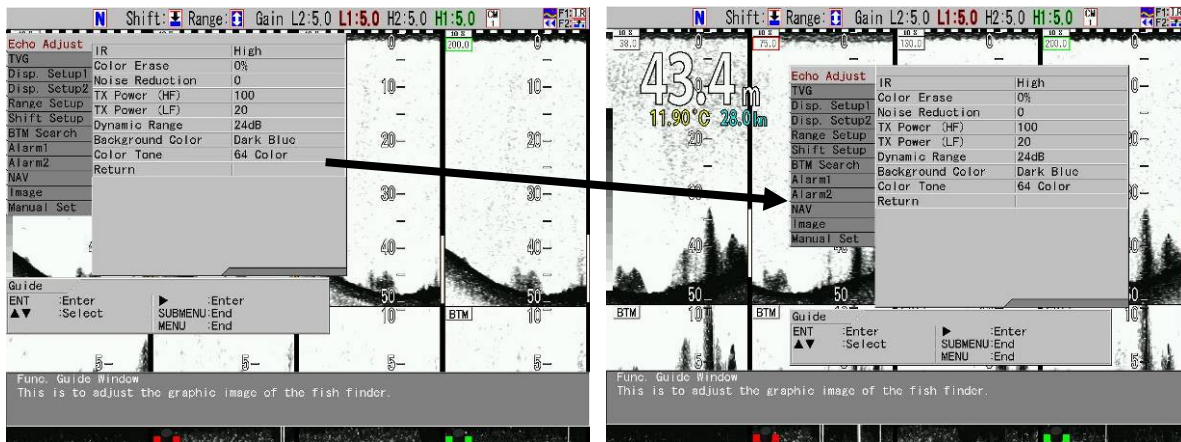



## Chapter 5 Maintenance and Inspection

### 5.1 Inspection

The daily maintenance and inspection extend the life of equipment. To keep the equipment always in the best conditions, implement the periodical inspection shown in the table below.

Item	Inspection item
Connectors at the rear of Processor unit	Check the looseness
Wiring of cables	Check the wiring of cables connecting the equipment and the damage of cable
Grounding of Processor unit	Scrape the rust off the ground terminal and keep good contact .

### 5.2 Cleaning

#### 5.2.1 Display unit

Contamination on the screen may cause faint images. For cleaning the screen, wipe it with soft and clean cloth dipped in diluted neutral detergent. Pay full attention as the screen gets scratched easily. No solvent such as thinner shall be used.

 <b>CAUTION</b>	<p>The display screen has a special coating. Do not use a solvent such as paint thinner, acetone, alcohol, and benzene, etc. Strong rubbing may cause scratch.</p>
--	--

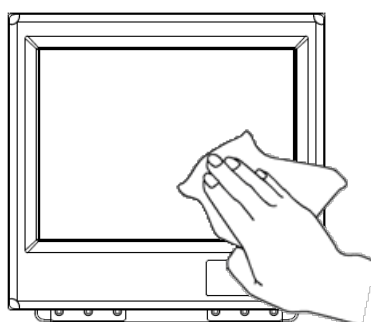

For cleaning the chassis, do not use solvent such as thinner or alcohol. Painting on the surface and characters at the Operation unit may be dissolved. After wiping with soft and clean cloth dipped with diluted neutral detergent, wipe away with dry soft and clean cloth.

### 5.2.2 Transducer

In the case of the through-hull installation, check the surface of opening of transducer (portion from which the ultra-sonic is emitted). If shells or oil adhere, scrub the surface with a wooden or bamboo knife with caution not to damage the surface and remove stuck materials. If you scrub strongly, the surface will be damaged, resulting in deteriorated performance of transducer.

### 5.3 Fuse Replacement



## WARNING

Use the specified fuse. If you use a fuse other than specified one, it may lead to a serious accident.

Fuse blows out when such a trouble occurs inside at too high input voltage or over current. The fuse is located in the power cable. Please replace with the fuse listed in the list of standard components.

### 5.4 Troubleshooting

Failure locations will be identified using following failure diagnostics table, and necessary actions shall be implemented.

Phenomenon/Indication	Possible cause	Countermeasures
Unit won't power "ON".	Power cable is disconnected.	Connect the power cable firmly to POWER connector. Wiring shall be secured.
	Power supply voltage is out of the specified range.	Set the voltage within the specified range (21.6 to 31.2 VDC).
	Power fuse is blown.	Replace the blown fuse with new one (after finding cause of failure). *The fuse shall be taken out after switching off the power.
LCD doesn't light up.	Inside LCD cable may not be securely connected.	Please contact the LCD manufacturer.
	LCD is defective.	Please contact the LCD manufacturer.
Cannot adjust the brightness of the LCD.	LCD is defective.	Please contact the LCD manufacturer.
Image doesn't change.	[Image Speed] is in [Stop] state.	Press [NAV] key → Change the setting of [Image Speed].
	With [Image Recall], called out image is displayed.	Comment blinks at upper left. Press [MENU] key to return to the original screen.
Image doesn't appear on the screen.	Transducer is not connected.	Connect the transducer firmly to TD connector.
	[Image Speed] is in [Stop] state.	Press [NAV] key → Change the setting of [Image Speed].
	Transducer is defective.	Request for repair, when the insulation value in Service Manual [3.3.1 Measurement of dielectric resistance] is not the specified value.
	Gain is too weak.	Turn the [GAIN Knob] clockwise to increase gain.

Not enough gain.	Gain is too weak.	Turn the [GAIN Knob] clockwise to increase gain.
	Sealife may be growing on transducer surface.	Carefully clean the transducer not to damage it.
	Transducer is defective.	Request transducer repair, when the insulation value in Service Manual [3.3.1 Measurement of dielectric resistance] is not the specified value.
A lot of interference noise	As the mounting position of the transducer is not appropriate, engine noise may have influence on it.	Find a position with lower noise, such as relocating it away from propellers or installation of it inside of the first stripe line.
	Grounding wire may be loose, or rusted.	After removal of rust, connect the grounding wire securely.
	Echo sounder with the same frequency on other boats may have influence on it.	Change the setting of [Echo Adjust] → [IR] in MENU. [High] will function well.
Keys are not operational.	Keys may be broken.	With [Maintain] → [System Check] → [Panel Test] in SUB MENU, perform checking of keys. When they are normal and when they are pressed, the positions corresponding to the keys on the screen will change to blue. If they do not change to blue, request repair.
	Keys are locked.	Release the key lock with [Maintain] → [Key Lock] → [OFF] in SUB MENU.
Depth display shows ----.	Sea bottom is not displayed on the screen.	Change the range to give sea bottom.
Display of water temperature shows abnormal. (In the case where the built-in water temperature sensor is connected.)	A water temperature sensor is not connected.	Refer to Service Manual "Chapter 2 Cable connection".
	A water temperature sensor might be broken down.	Inspect a water temperature sensor, refer to Service Manual "3.4 Inspection of water temperature sensor".
Display of water temperature shows abnormal. (In the case where being input as NMEA 0183 data from other navigation equipment)	[Temp source] is set at [Inside Sensor].	Set [In out] → [Temp source] in MENU to [NMEA].
	Connection to other navigation equipment may not be properly done.	Refer to Service Manual "Chapter 2 Cable connection".
Speed display shows abnormal. (In the case where a speed sensor is connected).	[Speed source] is set at [NMEA].	Set [In Out] → [Speed source] in MENU to [Inside Sensor].
	A water temperature sensor / speed sensor is not connected.	See Service Manual Chapter 2 Cable connection.
Speed display shows abnormal. (In the case where being input as NMEA 0183 data from other navigation equipment)	[Speed source] is set at [Inside Sensor].	Set [In Out] → [Speed source] in MENU to [NMEA].
	A water temperature sensor / speed sensor is not connected.	See Service Manual Chapter 2 Cable connection.

<p>“Position data is missing” is displayed.</p>	<p>Position information from GPS sensor or other navigation equipment is not input.</p>	<p>See Service Manual "Chapter 2 Cable connection", double check connection. After connection, setting [In out] → [NMEA monitor] in MENU to [ON], enable to monitor the data input. Confirm that position information is input.</p>
<p>“A Wpt list is full. Registration is not completed” is displayed.</p>	<p>Waypoint list is full.</p>	<p>Deleting waypoints may enable new registration. Delete unnecessary waypoints with [NAV] → [WPT delete] in MENU.</p>
<p>“A list Pic is full. Registration is not completed” is displayed.</p>	<p>Image memory list is full.</p>	<p>Deleting images may enable new registration. Delete unnecessary images with [Image] → [Image delete] in MENU.</p>





## Chapter 6 Specifications

Item	Content
Model	JFC-180BB
Display unit	—
Processor unit	NCM-1810J/E
Operation unit	NCH-1800J/E
Output power (RMS)	3kW
Transducer (Output frequency)	TDM-052A(38 to 75kHz and 130 to 210kHz) TDM-062A(38 to 75kHz and 85 to 135kHz)
Selectable frequency range	24 to 240kHz 0.1kHz step
Output method	Simultaneous / Alternate
TX rate	3000times / minute at maximum (In case of single frequency, Range 2.5m and Interference rejection off)
Pulse width	50μs to 3.0ms
Display resolution	1024 x 768 (XGA) (Owner supply)
Basic ranges	1 to 3000(m), 5 to 8000(ft), 1 to 1700(fm), 1 to 2000(l.fm) (8 ranges can be set to users choice)
Zoom ranges	1 to 260(m), 5 to 960(ft), 1 to 140(fm), 1 to 180(l.fm)
Range units	m, ft, fm, l.fm
Shift	Max 3000m, 10000(ft), 1600(fm), 1800(l.fm)
Shift step	Selectable : 1m, Range ratio 1/5, Registered value(8 types), Shift digit input, Range dependant
Presentation modes	High frequency, Low frequency, 1 to 4 frequency, Zoom image(Bottom lock, Bottom discrimination, Bottom zoom, Zoom, Bottom follow zoom), Nav mode, Vertical split, Horizontal split, Mix A-scope can be displayed at all above modes
Presentation colors	64colors, 16 colors, 8 colors, Monochrome
Back ground colors	Marine blue, Blue, Dark blue, Black, White, Nighttime color, Other 4 colors
Alarms	Bottom, Fish, Temperature*, Speed**, Arrival***, XTE***
Image speed	9steps & stop
Functions	Interference rejection, Color rejection, VRM, Noise reduction, White line, Draft correct, Water temperature correct, Boat speed correct, Store image(500images), Sona-Tone™, Fishing Hot Spot, Event memory, Simple plotter, Panel illumination, Power reduction, External trigger, Detection area display, CM key, Water Temp. graph, Individual range operation, Individual shift operation, External memory storage (SD card, USB memory), Heaving compensation
Auto functions	Range, Shift, TVG, TX Power, White line
Function registration	A scope, Shift digit input, Interference rejection, Color rejection, Noise reduction, White line, Background color, TGV adjust, VRM interval, Image recall, Image swap, Image title, Sona-Tone™, Nav start
Languages	Chinese****, English, French, Greek****, Italian****, Japanese, Korean, Spanish, Thai
Input data formats and sentences	NMEA0183 Ver.1.5/2.0/3.0 GGA, GLL, HDT, MTW, MWV, MWD, RMC, VHW, VTG, ZDA
Output data formats and sentences	NMEA0183 Ver.2.0(DBT : Ver.1.5) DBT, DPT, GGA, GLL, HDT, MTW, MWV, RMC, TLL, VHW, VTG, ZDA
NMEA ports	Total 2 : input and output
Power supply	21.6 to 31.2VDC
Power consumption	50W or less(24VDC)
Environmental	
Operating temperature	-15°C to +55°C
Water protection	IPX5(Operation unit) n/a(Processor unit)
Store temperature	-30°C to +70°C
Upper limit of humidity	93%±3%(At +40°C)
Dimension of equipment (without knob & pedestal)	Processor unit : 320 x 320 x 122mm Operation unit : 100 x 324.3 x 55mm
Dimension of equipment (with knob & pedestal)	— Operation unit : 100 x 324.3 x 55mm
Weight	Processor unit : 5.6kg Operation unit : 0.7kg

\* Requires data from Temp sensor

\*\* Requires speed data from Speed sensor or GPS sensor

\*\*\* Requires data from GPS sensor



# Chapter 7 Outline Drawing

## Processor unit NCM-1810J/E Outline Drawing

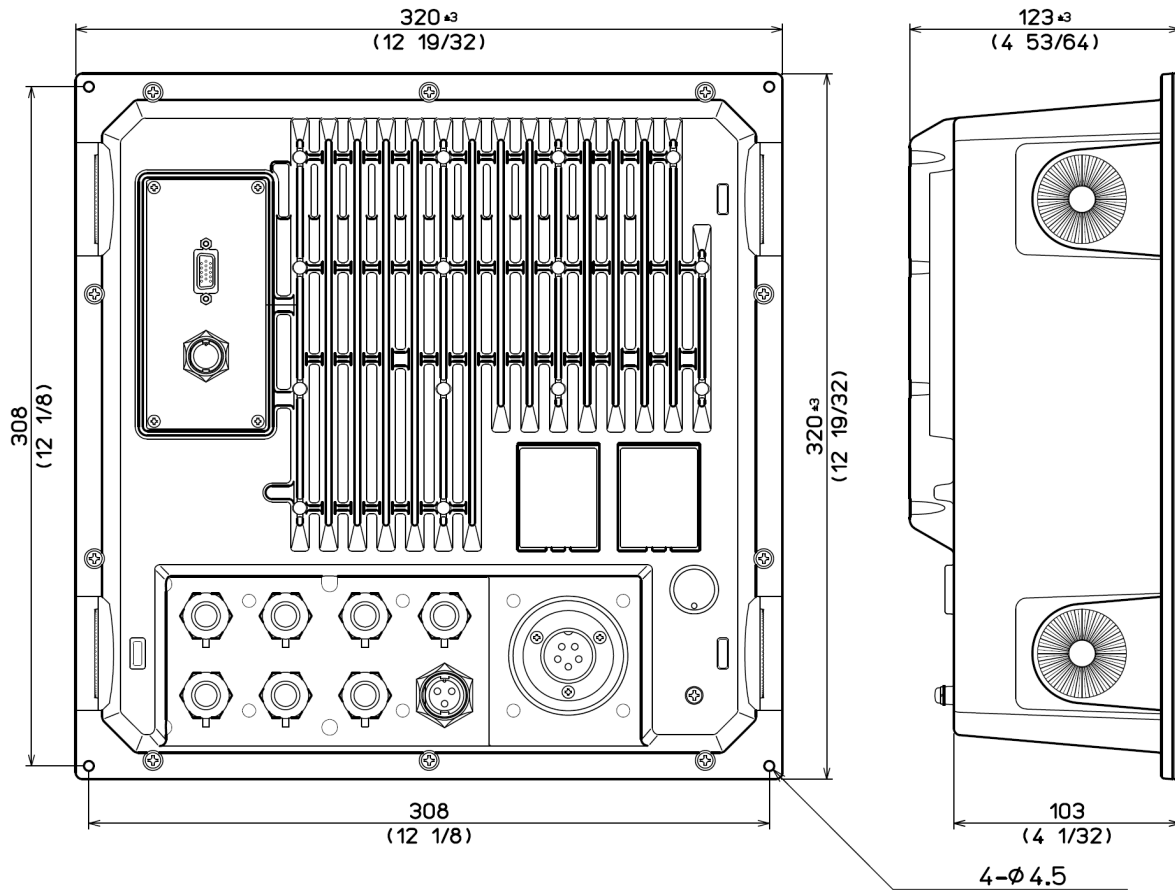

Unit: mm (inch)  
Mass: 5.6kg

Operation unit NCH-1800J/E Outline Drawing

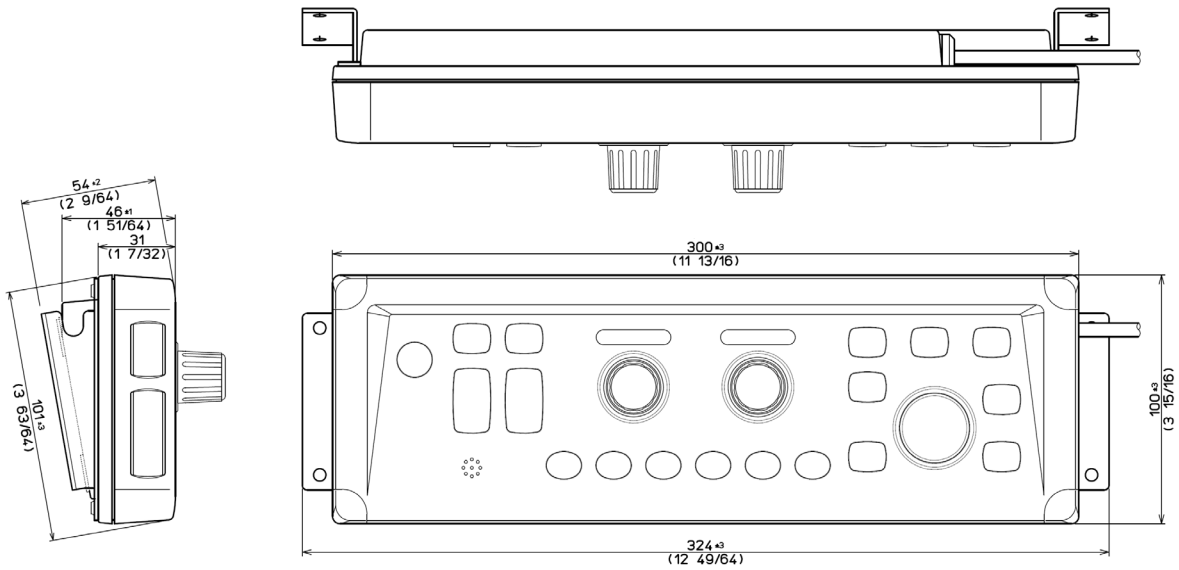

Unit: mm (inch)  
Mass:0.7kg

Transducer TDM-052A/062A Outline Drawing

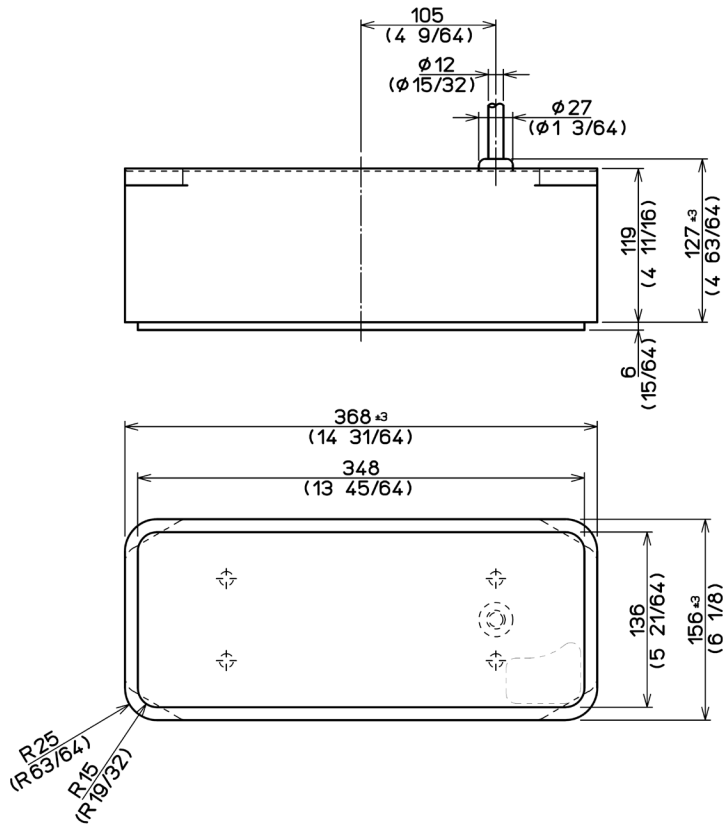

Cable length / ケーブル長 : 15M (590 35/64)	
Weight / 重量	TDM-052A / 11kg (24.5lb)
	TDM-062A / 11.5kg (25.5lb)
Material / 素材 : Polyurethane (ゴムモールド)	

Unit: mm (inch)

## Chapter 8 Index

### A

A Scope ..... 4-2  
 Absorption attenuation ..... 2-57  
 Adjustment of gain ..... 2-25  
 Alarm range bar ..... 1-18, 4-1  
 All Screens Same ..... 2-31, 2-38, 4-4, 4-7  
 Alternate transmission ..... 2-5  
 Auto Range ..... 2-26, 4-3, 4-4  
 Auto Shift ..... 2-26, 4-3, 4-6

### B

B.D. .... 3-2, 3-5  
 B.D. Mode ..... 4-2  
 B.F.Z. .... 3-5  
 B.Z. .... 3-5  
 Background Color ..... 4-2  
 Bottom ..... 2-7, 3-5  
 Bottom discrimination ..... 2-8  
 Bottom follow zoom ..... 2-11  
 Bottom zoom ..... 2-10  
 Broadband type transducer ..... 2-4  
 BTM Search ..... 4-5

### C

Change range ..... 2-28, 2-34  
 Change shift ..... 2-28  
 CM key ..... 2-1, 3-1, 3-2, 3-4, 3-8  
 CM Key Usage ..... 3-3, 3-7  
 CM Menu ..... 2-1, 3-4  
 CM number ..... 3-2  
 Color Bar Scale ..... 1-18, 4-1  
 Color Erase ..... 2-80, 4-2

Color Tone ..... 4-2  
 Control box ..... 4-1  
 Current Image ..... 2-54  
 Cycle period ..... 4-4, 4-5, 4-6

### D

Depth range ..... 4-3, 4-4  
 Depth Unit ..... 4-2  
 Diffusional attenuation ..... 2-57  
 Dust ..... 2-80, 2-83  
 Dynamic range ..... 2-83, 2-85

### E

Echo Adjust ..... 2-84  
 Echo sounder display ..... 1-16  
 Echo sounder image ..... 1-18, 4-1  
 Echo sounder's screen ..... 1-16  
 Enlargement range bar ..... 4-1  
 Event ..... 4-8, 4-9, 4-10  
 Event Key Usage ..... 4-2, 4-10

### F

F1 ..... 4-1, 4-2  
 F2 ..... 4-1, 4-2  
 Factory default ..... 2-3  
 False image ..... 2-67  
 Fish size in fish school size ..... 2-15  
 Frequency ..... 2-3, 2-5, 4-2  
 Frequency bandwidth ..... 2-22, 2-80  
 Frequency range ..... 2-5  
 Func. Guide Window ..... 1-10, 1-13  
 Function guide ..... 1-10, 1-13  
 Function key ..... 4-1, 4-2

**G**

Gain ..... 3-2, 3-6, 3-8, 3-9  
 Gain adjustment.....2-46, 2-50  
 Gain change type.....2-53  
 Gain knob ..... 1-7  
 Gain knob icon ..... 1-18  
 GGA..... 4-8, 4-9  
 GLL ..... 4-8, 4-9  
 Guide Window .....1-10, 1-13, 4-13

**H**

Header display 1-16, 3-2, 3-6, 3-10, 3-11, 4-1,  
 4-3, 4-4, 4-7  
 High frequency.....3-5  
 Homing..... 4-8, 4-9

**I**

Icon ..... 1-16, 4-2  
 Image list ..... 4-8  
 Image Recall ..... 4-2  
 Image scroll ..... 4-8  
 Image Speed ..... 2-67  
 Image Swap..... 4-2  
 Image title ..... 1-18, 4-1, 4-2  
 Individual mode..... 2-46  
 Individual range ..... 2-35  
 Individually adjustment ..... 2-25  
 Interference..... 2-76  
 IR (Interference Rejection)..... 4-2  
 IR (Interference Rejection)..... 2-76, 2-78

**K**

Key lock ..... 3-9, 4-2  
 Key Name ..... 1-6

**L**

Language ..... 1-9

Long-press ..... 1-7

**M**

Manual ..... 2-26, 2-29, 4-3  
 Manual Set ..... 2-20, 2-23  
 Manual shift..... 2-36  
 Manual TVG ..... 2-55, 2-60  
 Maximum search range ..... 4-4, 4-5, 4-6  
 Memory check..... 1-8  
 MENU..... 1-10, 3-6, 3-8, 3-9  
 Menu moving..... 4-13  
 Mixed image..... 2-15, 2-16

**N**

Nav Start ..... 4-2  
 NAV1 ..... 4-9  
 Navigation calculation ..... 4-9  
 NMEA0183 ..... 4-8, 4-9  
 Noise ..... 2-76, 2-85  
 Noise Reduction..... 2-83, 2-84, 2-85, 4-2  
 Normal screen..... 3-2  
 Numeric Value..... 2-40

**O**

One touch..... 2-1, 3-1, 4-1, 4-12  
 One touch switch..... 3-1, 3-6, 3-7, 3-10, 3-11  
 Operation guide..... 1-10, 1-13  
 Optimized TVG..... 2-55, 2-57

**P**

Panel Brill ..... 1-19  
 Particular depth fishing ..... 2-9  
 Plankton ..... 2-76, 2-80, 2-83  
 Pop-up message ..... 3-9  
 Position information ..... 4-9  
 Power voltage ..... 1-9  
 Preset Value ..... 2-41

Pulse length..... 2-19, 2-80, 3-2

## R

Random Transmission..... 2-79

Range ..... 3-2, 3-6, 3-8, 3-9

Range bearing ..... 4-9

Range Dependant ..... 2-40

Range key ..... 4-3

Range Mode ..... 1-16, 2-26, 4-3

Range of zoomed image ..... 2-12

Range Ratio..... 2-41

Range registration menu ..... 4-12

Range Setup..... 4-12

Register range ..... 2-32

Register shift..... 2-41

Registered range ..... 4-12

Retractive Gain..... 2-54

RMC ..... 4-8, 4-9

## S

Scale..... 1-18

Scr. Individual ..... 2-31, 2-38, 4-4, 4-7

Screen individual shift ..... 2-44

Screen mode..... 3-1, 3-2, 3-4, 3-6, 3-8, 3-9, 3-10, 3-11

Screen width..... 2-13

SD card..... 1-18

Sea bottom search mode ..... 4-4, 4-5, 4-6

Set item ..... 3-6

Setting value..... 3-2

Shift ..... 3-2, 3-6, 3-8, 3-9

Shift change box..... 2-43

Shift Digit Input ..... 4-2

Shift key ..... 4-3

Shift OFF ..... 2-44

Shift position ..... 2-9, 2-12, 4-6

Shift Type ..... 2-40

Shortcut..... 4-12

Simultaneous transmission..... 2-5

Sounding Limit ..... 4-5

Standard Echo Display ..... 2-1

Standard echo display item ..... 3-4

Start-up screen ..... 1-8

Store Image ..... 4-8

Store Position ..... 4-8

SUBMENU ..... 1-13, 3-6

Switch setting..... 3-1

Synchronized gain ..... 2-25, 2-51

Synchronized mode ..... 2-46

System ..... 3-3, 3-7, 4-10

## T

Time marker ..... 1-18

TLL..... 4-8

Transducer..... 2-3

TVG..... 2-80

TVG Adjust..... 2-59, 2-62, 2-66, 4-2

TVG Depth..... 2-62, 2-66

TVG Strength..... 2-62, 2-65

Types of zoomed image..... 2-7

## U

USB memory..... 1-18

## V

Vessel speed ..... 1-18

VRM ..... 2-69

VRM Interval ..... 2-70, 4-2

## W

Water depth ..... 1-18

Water temperature ..... 1-18

Waypoint navigation..... 4-9

White Line .....4-2

**Z**

Zoom..... 2-9, 2-12, 3-5

Zoom Display.....3-5

Zoom image ..... 2-6

Zoom image title..... 1-18

Zoom range bar..... 1-18

Zoom screen ..... 3-2





アスベストは使用しておりません  
Not use the asbestos

*For further information, contact:*



*Japan Radio Co., Ltd.*

*Since 1915*

URL Head office : <http://www.jrc.co.jp/eng/>

Marine Service Department

1-7-32 Tatsumi, Koto-ku, Tokyo 135-0053, Japan

e-mail : [tmsc@jrc.co.jp](mailto:tmsc@jrc.co.jp)

One-call : +81-50-3786-9201

ISO 9001, ISO 14001 Certified