

JMA-1030Series

**MARINE RADAR
EQUIPMENT**

**INSTRUCTION
MANUAL**

PRECAUTIONS BEFORE OPERATION



Cautions for High Voltage

High voltages, ranging from several hundreds to tens of thousands of volts, are used in electronic apparatus, such as radio and radar instruments. These voltages are totally harmless in most operations. However, touching a component inside the unit is very dangerous. (Any person other than authorized service engineers should not maintain, inspect, or adjust the unit.) High voltages on the order of tens of thousand volts are most likely to cause instant deaths from electrical shocks. At times, even voltages on the order of several hundred volts could lead to electrocution. To defend against electrical shock hazards, don't put your hand into the inside of apparatus. When you put in a hand unavoidably in case of urgent, it is strongly suggested to turn off the power switch and allow the capacitors, etc. to discharge with a wire having its one end positively grounded to remove residual charges. Before you put your hand into the inside of apparatus, make sure that internal parts are no longer charged. Extra protection is ensured by wearing dry cotton gloves at this time. Another important precaution to observe is to keep one hand in your pocket at a time, instead of using both hands at the same time.

It is also important to select a secure footing to work on, as the secondary effects of electrical shock hazards can be more serious. In the event of electrical shocks, disinfect the burnt site completely and obtain medical care immediately.

Precautions for Rescue of Victim of Electric Shock

When a victim of electric shock is found, turn off the power source and ground the circuit immediately. If this is impossible, move the victim away from the unit as quick as possible without touching him or her with bare hands. He or she can safely be moved if an insulating material such as dry wood plate or cloth is used.

Breathing may stop if current flows through the respiration center of brain due to electric shock. If the electric shock is not large, breathing can be restored by artificial respiration. A victim of electric shock looks pale and his or her pulse may become very weak or stop, resulting in unconsciousness and rigidity at worst. It is necessary to perform first aid immediately.

FIRST-AID TREATMENTS

Method of First-Aid Treatment

☆ Precautions for First-Aid Treatments

Apply artificial respiration to the person who collapsed, minimizing moving as much as possible avoiding risks. Once started, artificial respiration should be continued rhythmically.

- (1) Refrain from touching the patient carelessly as a result of the accident; the first-aider could suffer from electrical shocks by himself or herself.
- (2) Turn off the power calmly and certainly, and move the patient apart from the cable gently.
- (3) Call or send for a physician or ambulance immediately, or ask someone to call doctor.
- (4) Lay the patient on the back, loosening the necktie, clothes, belts and so on.
- (5)
 - (a) Feel the patient's pulse.
 - (b) Check the heartbeat by bringing your ear close to the patient's heart.
 - (c) Check for respiration by bringing your face or the back of your hand to the patient's face.
 - (d) Check the size of patient's pupils.
- (6) Opening the patient's mouth, remove artificial teeth, cigarettes, chewing gum, etc. if any. With the patient's mouth open, stretch the tongue and insert a towel or the like into the mouth to prevent the tongue from being withdrawn into the throat. (If the patient clenches the teeth so tight that the mouth won't open, use a screwdriver or the like to force the mouth open and then insert a towel or the like into the mouth.)
- (7) Wipe off the mouth to prevent foaming mucus and saliva from accumulating.

★ Treatment to Give When the Patient Has a Pulse Beating but Has Ceased to Breathe

* Performing mouth-to-mouth artificial respiration - Fig. 1

- (1) Bend the patient's face backward until it is directed to look back. (A pillow may be placed under the neck.)
- (2) Pull up the lower jaw to open up the airway. (To spread the airway)
- (3) Pinching the patient's nose, breathe deeply and blow your breath into the patient's mouth strongly, with care to close it completely. Then, move your mouth away and take a deep breath, and blow into his or her mouth. Give rescue breathing twice in about 1 second and check if the chest rises. (always with the patient's nostrils closed).
- (4) Immediately, perform chest compressions. (perform uninterrupted chest compressions of 30 at the rate of about 100 times per minute. With each compression, depress the chest wall to a depth of approximately 4 to 5 cm.) Rapidly, give 2 rescue breaths. Continuously perform the combination of 30 chest compressions and 2 rescue breaths without interruption. (Perform the cardiac massage and mouth-to-mouth respiration)
- (5) Continue the cardiac massage and mouth-to-mouth respiration until natural respiration is restored.
- (6) If the patient's mouth won't open easily, insert a pipe, such as one made of rubber or vinyl, into either nostril. Then, take a deep breath and blow into the nostril through the pipe, with the other nostril and the mouth completely closed.
- (7) The patient may stand up abruptly upon recovering consciousness. Keep the patient lying calmly, giving him or her coffee, tea or any other hot drink (but not alcoholic drink) to keep him or her warm.

Mouth-to-mouth artificial respiration with the patient's head lifted



- [1]  (1) Lift the back part of the patient's head. Support the forehead with one of your hand and the neck with the other hand. → [1].
Many patients will have their airways opened by lifting their head in this way to ease mouth-to-mouth artificial respiration.
- [2]  (2) Closing the patient's mouth with your mouth, press your cheek against the patient's nose → [2].
Alternatively, hold the patient's nose with your finger to prevent air leak → [3].
- [3]  (3) Blowing air into the patient's lungs. Blow air into the patient's lungs until chest is seen to rise. (always with the patient's nostrils closed) Give rescue breathing twice in about 1 second and check if the chest rises.

Fig. 1 Mouth-to-mouth artificial respiration

★ Treatment to Give When the Patient Has No Pulse Beating and Has Ceased to Breathe

* Performing cardiac massage - Fig. 2

If the patient has no pulse beating, with the pupils open and no heartbeat being heard, the patient has a cardiac arrest and requires immediate artificial respiration. Continue this until a medical specialist arrives, and follow his or her directions after that.

- (1) Putting one hand on about the lower one third of the patient's ribs and the other hand over the back of the first, with your elbow fully stretched (with bended elbow, you can't press to the extent the patient's ribs are depressed), apply your body weight to the hands to press the patient's body until it is depress the chest wall to a depth of approximately 4 to 5 cm. (Chest compressions of 30 at the rate of about 100 times per minute.). (Cardiac massage)
- (2) If only one first-aider is available, perform a cardiac massage about 30 times and then give mouth-to-mouth artificial respiration 2 times. Repeat this sequence.
If two first-aiders are available, while one person performs a cardiac massage 30 times, the other should give mouth-to-mouth artificial respiration 2 times. Repeat this sequence. (Combined cardiac massage and mouth-to-mouth artificial respiration method)
- (3) Check the patient's pupils and feel the pulse from time to time. When the pupils are restored to normal and the pulse begins to beat regularly, stop treating and keep the patient calm while giving him or her coffee, tea or any other hot drink to keep him or her warm while watching him or her carefully.

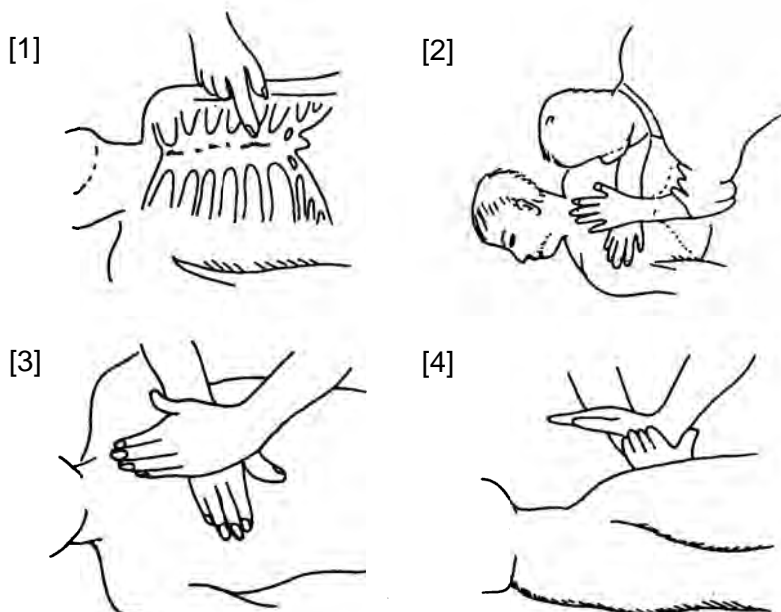
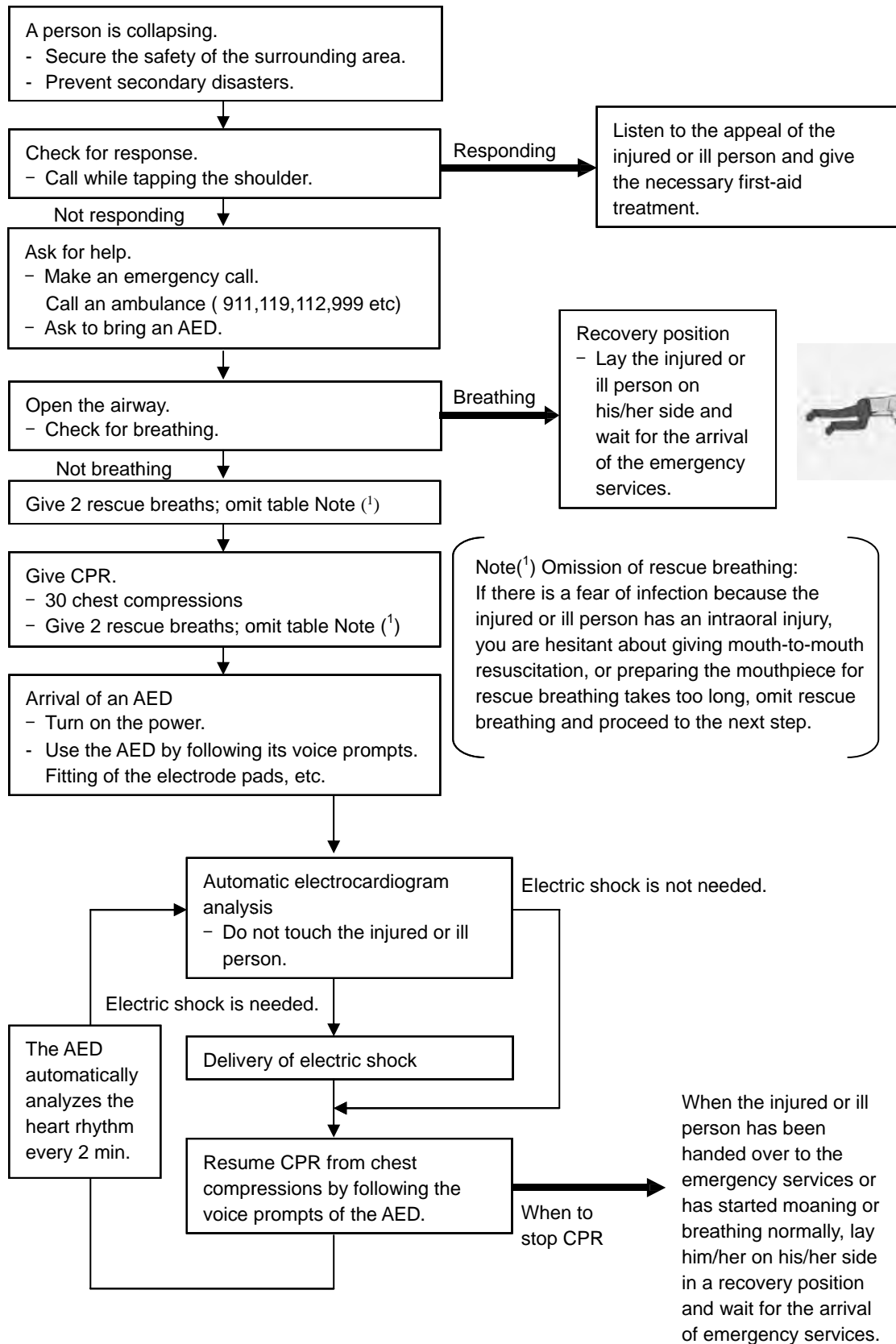

Fig. 2 Cardiac massage

Procedure for Cardiopulmonary Resuscitation (CPR) Using the AED (Automated External Defibrillator)



Procedure for Cardiopulmonary Resuscitation (CPR) Using the AED (Automated External Defibrillator)

1. Check the scene for safety to prevent secondary disasters

- a) Do not touch the injured or ill person in panic when an accident has occurred. (Doing so may cause electric shock to the first-aiders.)
- b) Do not panic and be sure to turn off the power. Then, gently move the injured or ill person to a safe place away from the electrical circuit.



2. Check for responsiveness

- a) Tap the shoulder of the injured or ill and shout in the ear saying, "Are you OK?"
- b) If the person opens his/her eyes or there is some response or gesture, determine it as "responding." But, if there is no response or gesture, determine it as "not responding."

3. If responding

- a) Give first-aid treatment.

4. If not responding

- a) Ask for help loudly. Ask somebody to make an emergency call and bring an AED.
 - Somebody has collapsed. Please help.
 - Please **call an ambulance**. (Call 911, 119, 112, 999 etc. by local number)
 - Please bring an **AED**.
 - If there is nobody to help, call an ambulance by yourself.



5. Open the airway

- a) Touch the forehead with one hand. Lift the chin with the two fingers of the middle finger and forefinger of the other hand and push down on the forehead as you lift the jaw to bring the chin forward to open the airway. If neck injury is suspected, open the airway by lifting the lower jaw.



6. Check for breathing

- a) After opening the airway, check quickly for breathing for no more than 10 seconds. Put your cheek down by the mouth and nose area of the injured or ill person, look at his/her chest and abdomen, and check the following three points.
 - Look to see if the chest and abdomen are rising and falling.
 - Listen for breathing.
 - Feel for breath against your cheek.



- b) If the injured or ill person is breathing, place him/her in the recovery position and wait for the arrival of the emergency services.
 - Position the injured or ill person on his/her side, maintain a clear and open airway by pushing the head backward while positioning their mouth downward. To maintain proper blood circulation, roll him/her gently to position them in the recovery position in the opposite direction every 30 minutes.



7. Give 2 rescue breaths (omittable)

- a) If opening the airway does not cause the injured or ill person to begin to breathe normally, give rescue breaths.
- b) If there is a fear of infection because the injured or ill person has an intraoral injury, you are hesitant about giving mouth-to-mouth resuscitation, or getting and preparing the mouthpiece for rescue breathing takes too long, omit rescue breathing and perform chest compressions.
- c) When performing rescue breathing, it is recommended to use a mouthpiece for rescue breathing and other protective devices to prevent infections.
- d) While maintaining an open airway, pinch the person's nose shut with your thumb and forefinger of the hand used to push down the forehead.
- e) Open your mouth widely to completely cover the mouth of the injured or ill person so that no air will escape. Give rescue breathing twice in about 1 second and check if the chest rises.



8. Cardiopulmonary resuscitation (CPR) (combination of chest compressions and rescue breaths)

a) Chest compressions

1) Position of chest compressions

- Position the heel of one hand in the center of the chest, approximately between the nipples, and place your other hand on top of the one that is in position.

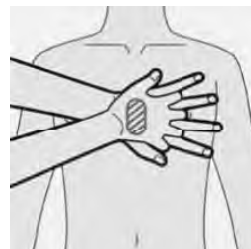
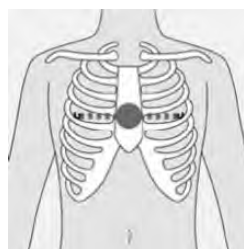

2) Perform chest compressions

- Perform uninterrupted chest compressions of 30 at the rate of about 100 times per minute
- While locking your elbows positioning yourself vertically above your hands.
- With each compression, depress the chest wall to a depth of approximately 4 to 5 cm.

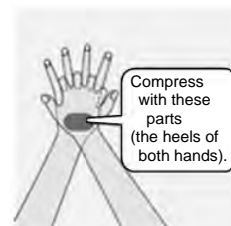

b) Combination of 30 chest compressions and 2 rescue breaths

- 1) After performing 30 chest compressions, give 2 rescue breaths. If rescue breathing is omitted, perform only chest compressions.
- 2) Continuously perform the combination of 30 chest compressions and 2 rescue breaths without interruption.
- 3) If there are two or more first-aiders, alternate with each other approximately every two minutes (five cycles of compressions and ventilations at a ratio of 30:2) without interruption.

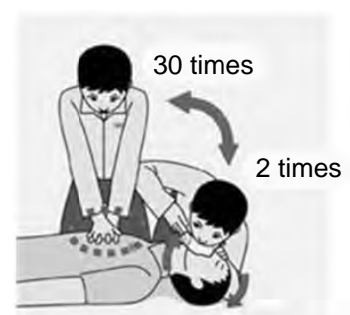

9. When to stop cardiopulmonary resuscitation (CPR)

- a) When the injured or ill person has been handed over to the emergency services
- b) When the injured or ill person has started moaning or breathing normally, lay him/her on his/her side in a recovery position and wait for the arrival of emergency services.



10. Arrival and preparation of an AED

- a) Place the AED at an easy-to-use position. If there are multiple first-aiders, continue CPR until the AED becomes ready.
- b) Turn on the power to the AED unit. Depending on the model of the AED, you may have to push the power on button, or the AED automatically turns on when you open the cover.
- c) Follow the voice prompts of the AED.



11. Attach the electrode pads to the injured or ill person's bare chest

- a) Remove all clothing from the chest, abdomen, and arms (male or female).
- b) Open the package of electrode pads, peel the pads off and securely place them on the chest of the injured or ill person, with the adhesive side facing the chest. If the pads are not securely attached to the chest, the AED may not function. Paste the pads exactly at the positions indicated on the pads. If the chest is wet with water, wipe dry with a dry towel and the like, and then paste the pads. If there is a pacemaker or implantable cardioverter defibrillator (ICD), paste the pads at least 3cm away from them. If a medical patch or plaster is present, peel it off and then paste the pads. If the injured or ill person's chest hair is thick, paste the pads on the chest hair once, peel them off to remove the chest hair, and then paste new pads.
- c) Some AED models require to connect a connector by following voice prompts.
- d) Do not put child pads on adults (older than 8 years).

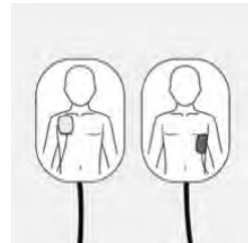

12. Electrocardiogram analysis

- a) The AED automatically analyzes electrocardiograms. Follow the voice prompts of the AED and ensure that nobody is touching the injured or ill person while you are operating the AED.
- b) On some AED models, you may need to push a button to analyze the heart rhythm.



13. Electric shock (defibrillation)

- a) If the AED determines that electric shock is needed, the voice prompt saying, "Shock is needed" is issued and charging starts automatically.
- b) When charging is completed, the voice prompt saying, "Push the shock button" is issued and the shock button flashes.
- c) The first-aiders must get away from the injured or ill person, make sure that no one is touching him/her, and then press the shock button.
- d) When electric shock is delivered, the body of the injured or ill person may jerk.



14. Resume cardiopulmonary resuscitation (CPR).

Resume CPR consisting of 30 chest compressions and 2 rescue breaths by following the voice prompts of the AED.

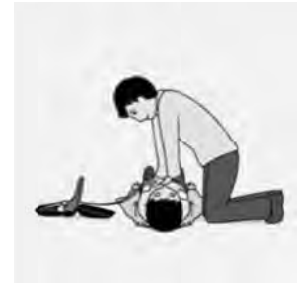
**15. Automatic electrocardiogram analysis**

- a) When 2 minutes have elapsed since you resumed cardiopulmonary resuscitation (CPR), the AED automatically analyzes the electrocardiogram.
- b) If you suspended CPR by following voice prompts and AED voice prompt informs you that shock is needed, give electric shock again by following the voice prompts.
If AED voice prompt informs you that no shock is needed, immediately resume CPR.

16. When to stop CPR (Keep the electrode pads on.)

- a) When the injured or ill person has been handed over to the emergency services
- b) When the injured or ill person has started moaning or breathing normally, lay him/her on his/her side in a recovery position and wait for the arrival of emergency services.



PREFACE

Thank you very much for purchasing the JRC marine radar equipment, JMA-1030 series. This equipment is a marine radar equipment designed to obtain safe operation of marine ships. This equipment consists of a scanner unit and a display unit as its main units.

- Before operating the equipment, be sure to read this instruction manual carefully for correct operation.
- Maintain this instruction manual so that operators can refer to it at anytime. Refer to this manual when any inconvenience or defect occurs.
- In this equipment manual, contains an easy operational bridge card on the appendix page. Please copy it and equip around the display unit.

About equipment type names:

JMA-1030 is a radar series model name.
Individual name is changed according with the combination of units.

JMA-1030 Series

JMA-1032	⇒	Display Unit NCD-2256 + Scanner Unit NKE-1066
JMA-1034	⇒	Display Unit NCD-2256 + Scanner Unit NKE-2044

CHECKING THE SUPPLIED ITEMS

STANDARD SUPPLY ITEMS

Standard supply items are as follows.
The normal installation cable length is 10m between scanner and display.
Optional special length cables are prepared by JRC if request.
Option cable is provided with a length of 5m, 15m, 20m, or 30m. (Please order it if necessary)

SCANNER UNIT	1 set /	DISPLAY UNIT	1 set /	SUN COVER	1 Piece
INSTALLATION CABLE (SCANNER TO DISPLAY)				1 Piece (Standard 10m)	
POWER CABLE (DC input cable 2m)		1 Piece			
STANDARD SPARE PARTS	1 Piece (7ZXR0032: SPARE FUSE: 58V/7.5A 2pieces)				
INSTRUCTION MANUAL	1 Piece (This book)				
TEMPLATE SHEET FOR SCANNER MOUNTING SCREW HOLES				1 Piece	

NOTE:

This radar display is possible to use AIS, TT, LL_ position, Depth, and N-UP functions. But those all functions need the signal input from GPS, AIS, GYRO, LOG, ECHO SOUNDERS. ALL external signals are connected using NMEA cable. This cable is sold separately as an optional accessory, it is not included in the standard supply items.

OPTION UNITS (Not included in standard supplied items)

Please order to JRC agent or factory if necessary.



- ☆ **SCANNER to DISPLAY Cable: 5m, 15m, 20m, 30m**
- ☆ **NMEA Signal connection cable: length 1m**
- ☆ **RGB external monitor connection unit (NQA-2447) (Not include a RGB monitor)**
- ☆ **Rectify unit (NBD-865): AC100/220V to DC24V**

BEFORE OPERATION

PICTORIAL INDICATION

Various pictorial indications are included in this manual and are shown on these equipment so that you can operate them safely and correctly and prevent any danger to you and/or to other persons and any damage to your property during operation. Such indications and their meanings are as follows.

Understand them before you read this manual.

 DANGER	This indication is shown where incorrect equipment operation due to negligence may cause death or serious injuries.
 WARNING	This indication is shown where any person is supposed to be in danger of being killed or seriously injured if this indication is neglected and these equipment are not operated correctly.
 CAUTION	This indication is shown where any person is supposed to be injured or any property damage is supposed to occur if this indication is neglected and these equipment are not operated correctly.

EXAMPLES OF PICTORIAL INDICATION



Electric Shock

The \triangle mark represents CAUTION (including DANGER and WARNING).

Detailed contents of CAUTION ("Electric Shock" in the example on the left) is shown in the mark.



Disassembling
Prohibited



Prohibited

The \odot mark represents prohibition.

Detailed contents of the prohibited action ("Disassembling Prohibited" in the example on the left) is shown in the mark.



Disconnect
the power plug



Instruction

The \bullet mark represents instruction.

Detailed contents of the instruction ("Disconnect the power plug" in the example on the left) is shown in the mark.

RUSSIA CTP MARK

According to the requirements of clause 20 of Technical Regulations about safety of Maritime transport objects, approved by Resolution of the Russian Federation Government #620 dated August 12, 2010 and requirements Technical Regulation of the Russian Federation Government #623 dated August 12, 2010 navigation & radiotelephone equipment should be marked by company – manufacturer with market-circulation mark the way it is determined by Legislation of the Russia federation on technical regulation.

According to the article 27 PZ No184 –FZ of Federal Law about Technical Regulation dated December 12, 2002 and Resolution of the Russian Federation Government dated 19.11.03 No0696 navigation equipment has an appropriate marking. The marking can be performed by one of four variants, depending on surface colour of equipment.

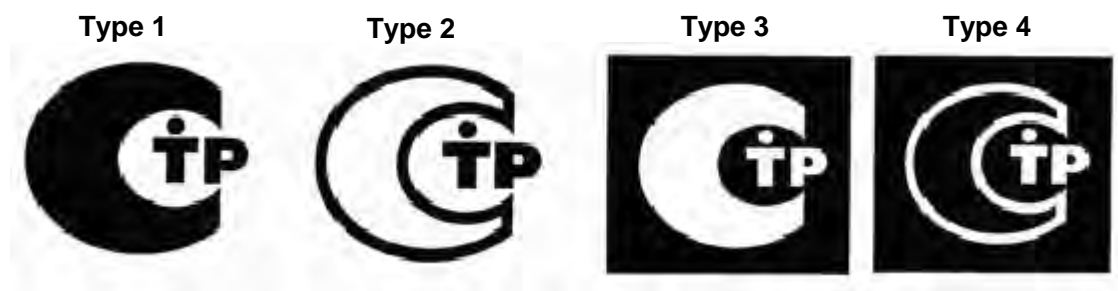





The images should be grey scale and should contrast against the surface colour (ref. to the Resolution of the Russian Federation Government No696 <<About market circulation mark>> dated November 19, 2003).







The marking of Radio and navigation equipment should be done by the manufacturer (supplier) according to the clause 2 of the article 27 of the Federal Law No.184 –FZ << About technical Regulation>> and should be applied right to device surface.

PRECAUTIONS







DANGER

	<p>Never carry out internal inspection or repair work of the equipment by users. Inspection or repair work by unauthorized personnel may result in fire hazard or electric shock.</p> <p>For inspection and repair work of equipment components, consult with our branch office, branch shop, sales office, or our distributor in your district.</p>
	<p>When conducting maintenance, make sure to turn the main power off. Failure to comply may result in electrocution.</p>
	<p>Turn off the main power before cleaning the equipment. Especially when a rectifier is used, make sure to turn it off since voltage is still output from the rectifier even after the radar is turned off.</p> <p>Failure to comply may result in equipment failure, electric shock or serious injury.</p>
	<p>When conducting maintenance work on the antenna, make sure to turn its main power off.</p> <p>Failure to comply may result in electrocution or injuries.</p>











WARNING

	<p>Never directly touch the internal components of the antenna, receiver/transceiver, or indicator.</p> <p>Direct contact with these high voltage components may cause electrocution. For maintenance, inspection, or adjustment of equipment components, consult with our branch office, branch shop, sales office, or our distributor in your district.</p>									
	<p>Microwave radiation level: Keep away from a scanner when it is transmitting. The high level of microwave is radiated from the front face of the scanner specified below. The microwave exposure at close range could result in injuries (especially of the eyes).</p> <table border="1" style="margin-left: auto; margin-right: auto; border-collapse: collapse; width: 80%;"> <thead> <tr> <th style="text-align: left;">Item under test</th> <th style="text-align: center;">100W/ m² or power at face of Antenna or Radome</th> <th style="text-align: center;">10W/ m² distance from Antenna or Radome</th> </tr> </thead> <tbody> <tr> <td style="text-align: center;">NKE-1066</td> <td style="text-align: center;">4.143 W/m²</td> <td style="text-align: center;">NA</td> </tr> <tr> <td style="text-align: center;">NKE-2044</td> <td style="text-align: center;">3.548 W/m²</td> <td style="text-align: center;">NA</td> </tr> </tbody> </table>	Item under test	100W/ m ² or power at face of Antenna or Radome	10W/ m ² distance from Antenna or Radome	NKE-1066	4.143 W/m ²	NA	NKE-2044	3.548 W/m ²	NA
Item under test	100W/ m ² or power at face of Antenna or Radome	10W/ m ² distance from Antenna or Radome								
NKE-1066	4.143 W/m ²	NA								
NKE-2044	3.548 W/m ²	NA								
	<p>Make sure to install the antenna at a place higher than human height. Direct exposure to electromagnetic waves at close range will have adverse effects on the human body.</p>									
	<p>Direct exposure to electromagnetic waves at close range will have adverse effects on the human body. When it is necessary to get close to the antenna for maintenance or inspection purposes, make sure to turn the indicator power switch to "OFF" or "STBY."</p>									
	<p>When conducting maintenance work, make sure to turn off the power and unplug the power connector J1 of the display unit so that the power supply to the equipment is completely cut off.</p> <p>Some equipment components can carry electrical current even after the power switch is turned off, and conducting maintenance work without unplugging the power connector may result in electrocution, equipment failure, or accidents.</p>									
	<p>Do not take apart, and do not remodel the display unit. This could cause water to seep inside the display unit.</p>									

CAUTION

	<p>A malfunction may occur if the power in the ship is instantaneously interrupted during operation of the radar. In this case, the power should be turned on again.</p>
	<p>Always use the automatic tuning mode. Use the manual tuning mode only when the automatic tuning mode does not provide the best tuning state due to deterioration of magnetron for example.</p>
	<p>If sensitivity is set too high, unnecessary signals such as noises in the receiver and false echoes increase to lower target visibility. At the same time, if sensitivity is set too low, detection of targets such as ships and dangerous objects may be hindered. Therefore, sensitivity must always be set to an optimal level.</p>
	<p>When using the sea clutter suppression function, never set the suppression level too high canceling out all image noises from the sea surface at close range. Detection of not only echoes from waves but also targets such as other ships or dangerous objects will become inhibited. When using the sea clutter suppression function, make sure to choose the most appropriate image noise suppression level.</p>
	<p>Use the radar only as a navigation aid. The final navigation decision must always be made by the operator him/herself. Making the final navigation decision based only on the radar display may cause accidents such as collisions or running aground.</p>
	<p>Use the target tracking function (TT) only as a navigation aid. The final navigation decision must always be made by the operator him/herself. Making the final navigation decision based only on the target tracking function (TT) information may cause accidents. The target tracking function (TT) information such as vector, target numerical data, and alarms may contain some errors. Also, targets that are not detected by the radar cannot be acquired or tracked. Making the final navigation decision based only on the radar display may cause accidents such as collisions or running aground.</p>
	<p>When a large value is set as an association condition, a tracked target near an AIS target is identified as the AIS target and may thus disappear from the display. For example, when a pilot vessel equipped with the AIS function (a small target which is not a tracked target) goes near a cargo vessel which is a tracked target without the AIS function, the tracked target symbol for the cargo vessel may disappear.</p>

CAUTION

	<p>Since these alarms may include some errors depending on the target tracking conditions, the navigation officer himself should make the final decision for ship operations such as collision avoidance.</p> <p>Making the final navigation decision based only on the alarm may cause accidents such as collisions.</p>
	<p>When setting an automatic acquisition zone, make sure to properly adjust gain, sea-surface reflection suppression level, and rain/snow reflection suppression level so that the optimal target images are always on the radar screen. The automatic acquisition zone alarm will not be activated for targets undetected by the radar, and it may result in accidents such as collisions.</p>
	<p>Any adjustments must be made by specialized service personnel. Incorrect settings may result in unstable operation.</p>
	<p>Do not make any adjustments during navigation. Failure to comply may result in adverse effects on the radar function which may lead to accidents or equipment failure.</p>
	<p>Any adjustments must be made by specialized service personnel. Failure to comply may result in accidents or equipment failure.</p>
	<p>Make sure to shut off the main power before replacing parts. Failure to comply may result in electrocution or equipment failure.</p>
	<p>When replacing magnetrons, make sure to shut off the main power and let the equipment stand for more than 5 minutes to discharge the high-voltage circuit.</p> <p>Failure to comply may result in electrocution.</p>
	<p>Make sure to take off your watch when your hand must get close to the magnetron. Failure to comply may result in damage to the watch since the magnetron is a strong magnet.</p>
	<p>When cleaning the display screen, do not wipe it too strongly with a dry cloth. Also, do not use gasoline or thinner to clean the screen.</p> <p>Failure to comply will result in damage to the screen surface.</p>
	<p>Do not take apart, and do not remodel the display unit. It may cause a fire, the electric shock, and the breakdown.</p>

WARNING LABEL MOUNTING POINT

Warning label is patched on the equipment visible surface.
Do not try to remove, break or modify the label.

NKE-1066 SCANNER UNIT

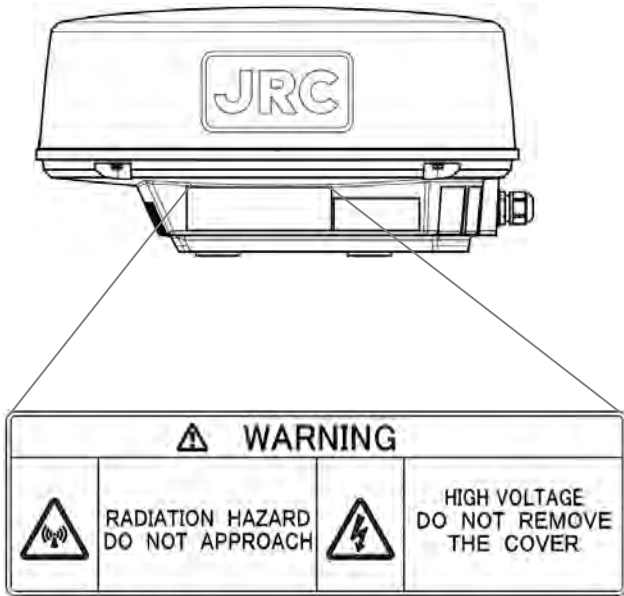

NKE-2044 SCANNER UNIT

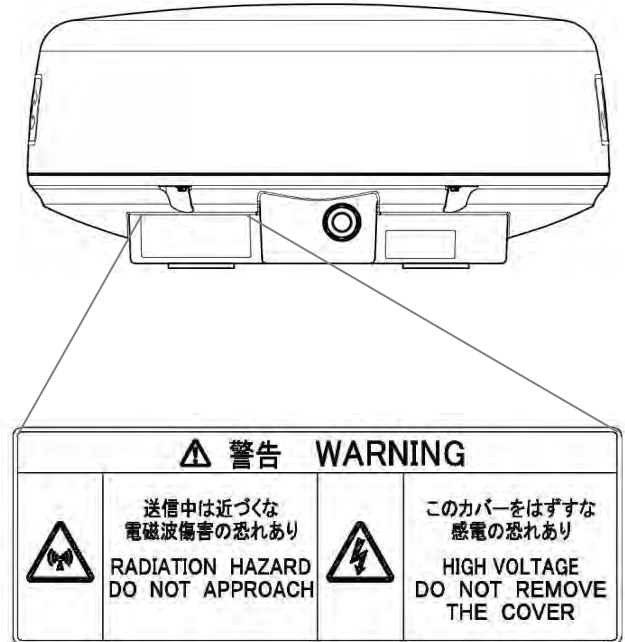



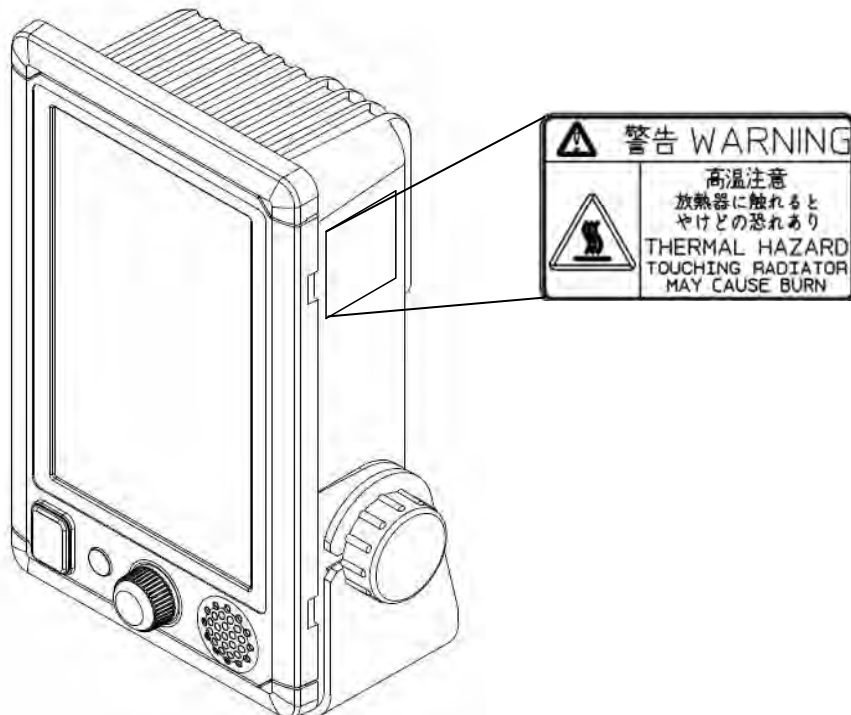





NCD-2256 DISPLAY UNIT



PACKING LIST



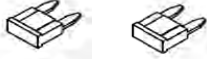
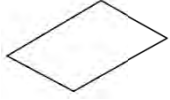
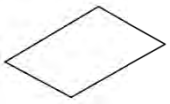



The packing lists of each unit are as follows.

NCD-2256: DISPLAY UNIT

Parts Name		Figure	Qty.
Display Unit [NCD-2256]			1
Sun Cover [MTV305222*]			1
Power Cable [CFQ-9900]			1
Instruction Manual [H-7ZPRD0895*]			1
Mounting Hardware [MPTG32528*]	Screw [5X20(L)]		5
	Washer [W5Bs]		5
Attached parts [MPXP35238*]	Name plate [MPNN48917*]		1
	Fuse [H-7ZXR0032*]		2
	Read Me [H-7ZPRD0898*]		1
Template [MTZ304757*]			1
NMEA Cable (Option) [H-7ZCRD1689*]			1







“ * ” means revision, such as A, B and so on.

NKE-2044: SCANNER UNIT

Parts Name		Figure	Qty.
Scanner Unit [NKE-2044]			1
Mounting Hardware [MPXP35114*]	Bolt [M8X30 SUS304]		4
	Spring Washer [SW8 SUS]		4
	Washer [W8 SUS]		4
	Instruction for Equipment [MTZ304691*]		1
Template [MTZ302447*]			1
Installation Cable [CFQ9924-10]			1

“ * ” means revision, such as A, B and so on.

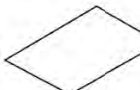
NKE-1066: SCANNER UNIT

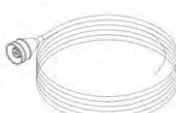
Parts Name		Figure	Qty.
Scanner Unit [NKE-1066]			1
Mounting Hardware [MPXP35115*]	Bolt [M8X30 SUS304]		4
	Spring Washer [SW8 SUS]		4
	Washer [W8 SUS]		4
	Instruction for Equipment [MTZ304694*]		1
Template [MTZ304696*]			1
Installation Cable [CFQ9924-10]			1

“ * ” means revision, such as A, B and so on.

EQUIPMENT APPEARANCE

JMA-1030 is a series name.

Individual TYPE name is changed by combination of units.

TYPE	JMA-1032	NCD-2256	+	NKE-1066
TYPE	JMA-1034	NCD-2256	+	NKE-2044

JMA-1030 Series system diagram

**1.5feet Scanner Unit
(NKE-1066)**

Radome diameter 450mm



JMA-1032 RADAR

**2feet Scanner Unit
(NKE-2044)**

Radome diameter 620mm



Installation cable:

CFQ9924-5, 10, 15, 20, 30
*STANDARD LENGTH: 10m
OPTION LENGTH:
5m/15m/20m/30m

JMA-1034 RADAR

External Navigational
Signal input.
NMEA 3 input ports

Ship's Main Power
(10.8-31.2VDC)

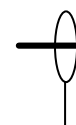

CFQ-9900

(Power Cable length 2m)

*INCLUDING FUSE IN PLUS LINE

FUSE TYPE: 58V/7.5A



7inch WIDE VGA COLOR LCD DISPLAY

(NCD-2256)



NKE-1066 SCANNER UNIT

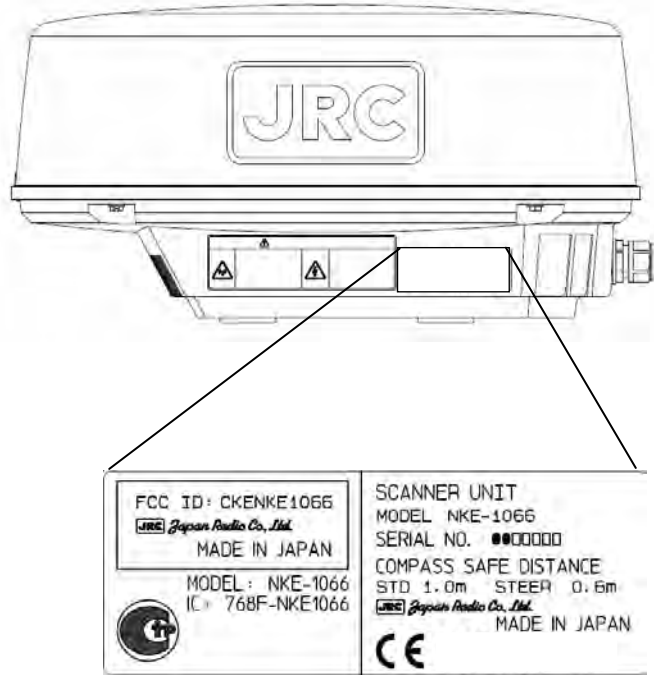

NKE-2044 SCANNER UNIT

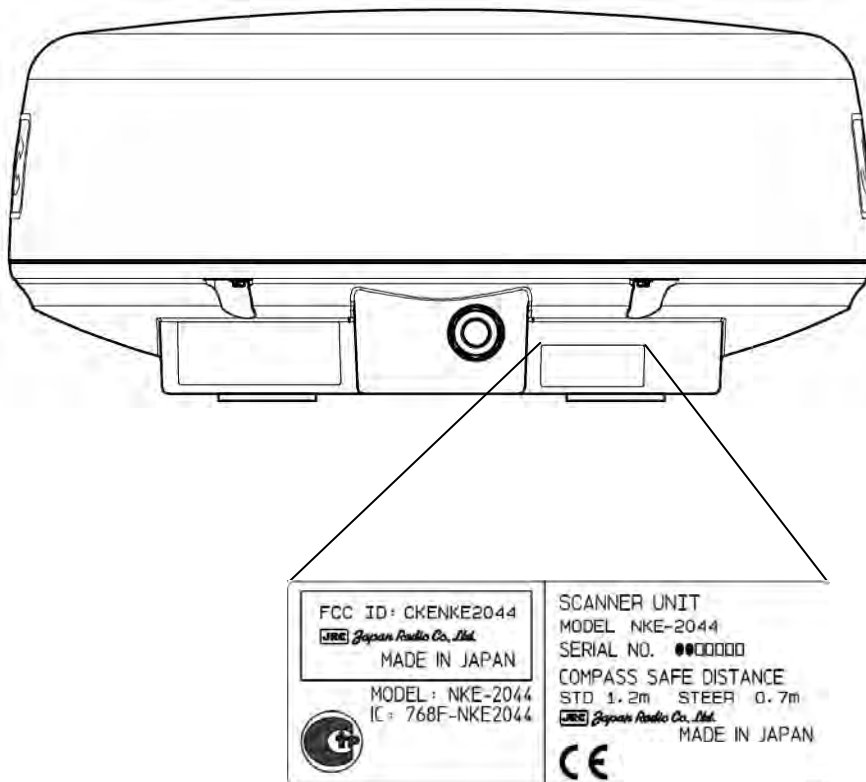

NCD-2256 DISPLAY UNIT

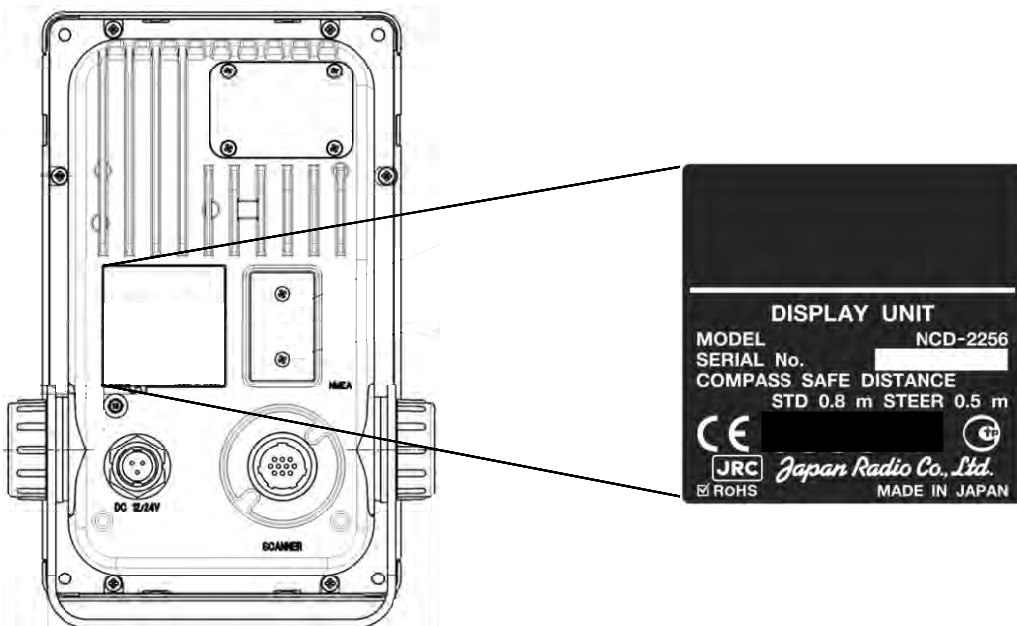

CONTENTS

PREFACE	x
CHECKING THE SUPPLIED ITEMS	x
BEFORE OPERATION	xi
PRECAUTIONS	xiii
WARNING LABEL MOUNTING POINT	xvii
PACKING LIST	xviii
EQUIPMENT APPEARANCE	xx
CONTENTS	xxiii
GLOSSARY	xxix
Chapter 1 INSTALLATION	1
1.1 OVERVIEW.....	1
1.2 INSTALLATION OF THE DISPLAY UNIT.....	2
1.2.1 SELECTING THE INSTALLATION POSITION	2
1.2.2 SELECTION OF DISPLAY MOUNTING.....	2
1.2.3 DIMENSIONAL DRAWING OF DISPLAY MOUNTING	3
1.2.4 EXAMPLES OF DISPLAY MOUNTING.....	5
1.2.5 POWER CABLE INSTALLATION	10
1.2.6 EXTERNAL NAVIGATIONAL SIGNAL CONNECTION	11
1.3 INSTALLATION OF THE SCANNER UNIT	12
1.3.1 SELECTING THE INSTALLATION POSITION	12
1.3.2 LOWEST SCANNER INSTALLATION HEIGHT.....	12
1.3.3 MOUNTING RACK AND MAST FOR THE SCANNER.....	13
1.3.4 SCANNER AND THE SURROUNDING STRUCTURAL OBJECTS	13
1.3.5 ENSURING VIEW ANGLE	14
1.3.6 CONFIRM MOUNTING BASE BEFORE INSTALL	16
1.4 CONNECTING THE INSTALLATION CABLE	19
1.4.1 NKE-1066 SCANNER (1.5 FEET).....	20
1.4.2 NKE-2044 SCANNER (2 FEET).....	24
Chapter 2 START THE BASIC OPERATION	28
2.1 PANEL AND SCREEN DISPLAY LAYOUT	29
2.2 POWER ON/OFF.....	30
2.3 SCREEN LAYOUT	32
2.3.1 STANDBY SCREEN.....	32
2.3.2 TRANSMISSION SCREEN	35
2.3.3 DISPLAY THE FUNCTION ICONS.....	36
2.4 BRIEF EXPLANATION OF ICON'S FUNCTION	40
2.5 SETTING THE RESIDENT ICONS.....	43

Chapter 3 ADJUST THE RADAR ECHO	44
3.1 CHANGE RANGE.....	44
3.2 SENSITIVITY ADJUSTMENT	45
3.3 SEA CLUTTER SUPPRESSION	46
3.4 RAIN/SNOW CLUTTER SUPPRESSION	47
3.5 SCREEN BRILLIANCE (another operation).....	48
Chapter 4 VRM AND EBL FUNCTION.....	50
4.1 OPERATION OF VRM, EBL	50
4.2 EXAMPLE OF VRM FUNCTION.....	50
4.3 EXAMPLE OF EBL FUNCTION.....	51
Chapter 5 VARIOUS FUNCTION ICONS.....	52
5.1 MOB FUNCTION (MAN OVERBOARD).....	52
5.2 OFF-CENTER FUNCTION.....	53
5.3 CURSOR FUNCTION	54
5.4 GUARD ZONE FUNCTION.....	55
5.5 RADAR TRAILS.....	56
5.5.1 SETUP THE TRAIL LENGTH	56
5.5.2 SETUP THE RADAR TRAILS REF LEVEL, etc	57
5.6 AIS OPERATIONS	59
5.7 TT OPERATIONS.....	60
5.8 MODE FUNCTION	62
5.9 SWITCHING DAY / NIGHT MODE	63
5.10 USER OPTION KEY.....	64
5.11 MARK FUNCTION.....	65
5.11.1 MEMO	65
5.11.2 LINE FUNCTION	66
5.11.3 SYMBOL MARKER	68
5.12 RADAR ECHO.....	69
5.12.1 PULSE LENGTH	70
5.12.2 IR (INTERFERENCE REJECTION).....	70
5.12.3 TARGET ENHANCE	71
5.12.4 PROCESS	71
5.12.5 VIDEO LATITUDE	71
5.12.6 VIDEO NOISE REJECTION.....	72
5.12.7 TIMED TX	72
5.13 TUNING	73
5.14 MOTION MODE.....	74
5.15 VECTOR LENGTH.....	75
5.16 MARKER.....	75
5.17 TARGET.....	76
5.17.1 FUNCTION ON/OFF.....	77
5.17.2 CPA LIMIT.....	77

5.17.3	TCPA LIMIT	77
5.17.4	CPA RING DISPLAY	77
5.17.5	TARGET NUMBER DISPLAY	77
5.17.6	ALR ALARM FROM AIS	77
5.17.7	AIS DISPLAY TARGETS	77
5.17.8	AIS LIST DISPLAY	77
5.18	NMEA INFO. SET	78
Chapter 6	OPTION FUNCTIONS.....	79
6.1	EXTERNAL MONITOR OUTPUT	79
6.2	NMEA CABLE	80
6.3	RECTIFIER UNIT	80
Chapter 7	INITIAL SETTINGS	81
7.1	LANGUAGE SELECTION	82
7.2	TUNING ADJUSTMENT	82
7.3	BEARING ADJUSTMENT	83
7.4	RANGE ADJUSTMENT	83
7.5	ANTENNA HEIGHT SET UP	84
7.6	NOISE LEVEL	84
7.7	COMMUNICATION PORT SETUP	85
7.7.1	BAUD RATE	85
7.7.2	RX PORT	86
7.7.3	TX PORT	86
7.7.4	TX DATA FORMAT	87
7.7.5	TARGET INFORMATION TX	87
7.8	I/F DEVICE	88
7.8.1	HEADING EQUIPMENT	89
7.8.2	MANUAL HEADING	89
7.8.3	SPEED EQUIPMENT	89
7.8.4	MANUAL SPEED	89
7.8.5	MAGNETIC COMPASS	89
7.9	JRC GPS (for future enhancements)	90
7.9.1	GPS STATUS DISPLAY	90
7.9.2	GPS SETTING	91
7.9.3	BEACON SETTING	95
7.9.4	SBAS SETTING	95
Chapter 8	DETAIL PERFORMANCE SETTINGS.....	96
8.1	SETS RADAR ECHO	96
8.1.1	MAIN BANG SUPPRESSION	97
8.1.2	TARGET ENHANCE LEVEL	97
8.1.3	GAIN PRESET	97
8.1.4	STC	98
8.1.5	FTC	98

8.1.6	RADAR ALARM LEVEL	99
8.2	TT FUNCTION	100
8.3	SCANNER FUNCTION	101
8.3.1	PULSE REPETITION FREQUENCY FINE TUNING (PRF FINE TUNING)	101
8.3.2	STAGGER TRIGGER.....	101
8.3.3	ANTENNA ROTATION SPEED	102
8.3.4	PRF MODE	102
8.3.5	TIMED TX	102
8.3.6	TUNE PEAK ADJUSTMENT	103
8.3.7	TUNE INDICATOR LEVEL.....	103
8.4	CONTROL	104
8.4.1	TOUCH PANEL CALIBRATION.....	104
8.4.2	BUZZER.....	105
8.5	MAINTENANCE SETTING.....	105
8.5.1	PARTIAL RESET	106
8.5.2	ALL RESET	106
8.5.3	SYSTEM TIME CLEAR	107
8.5.4	SCANNER TIME CLEAR	107
8.5.5	TABLE UPDATE	108
8.5.6	INTERNAL SETTING	109
8.5.7	USB FORMAT	111
8.6	SYSTEM SETTING	112
8.6.1	MASTER/SLAVE/DEMO	112
8.6.2	OWN SHIP OUTLINE	113
8.6.3	UNIT	113
8.6.4	MOVE OWN SHIP	114
8.6.5	USE RANGE SELECT	114
8.7	DISPLAY SCREEN.....	115
8.7.1	OWN VECTOR DISPLAY	115
8.7.2	STANDBY DISPLAY SELECT	116
8.7.3	OPERATION NUMERICAL DISPLAY	116
8.7.4	DISPLAY COLOR.....	116
8.7.5	WAYPOINT DISPLAY	116
8.7.6	AIS FILTER.....	117
8.8	ERROR ALARM MASK.....	117
8.8.1	SCANNER	118
8.8.2	DISPLAY UNIT	118
8.8.3	RX DATA.....	118
	Chapter 9 MAINTENANCE AND CHECK.....	119
9.1	ROUTINE MAINTENANCE	119
9.2	MAINTENANCE OF EACH UNIT.....	119
9.2.1	SCANNER NKE-1066.....	119

9.2.2	SCANNER NKE-2044.....	120
9.2.3	DISPLAY NCD-2256.....	120
9.3	PERFORMANCE CHECK.....	121
9.3.1	TEST MENU	122
9.3.2	SYSTEM INFORMATION.....	122
9.3.3	SYSTEM TIME.....	122
9.3.4	SCANNER INFORMATION.....	123
9.3.5	HARDWARE INFORMATION	123
9.3.6	ERROR LOG	123
9.3.7	LINE MONITOR.....	123
9.3.8	SELF TEST	123
9.4	REPLACEMENT OF MAJOR PARTS	124
9.4.1	PARTS REQUIRED FOR PERIODIC REPLACEMENT	125
9.5	FAULT FINDING.....	125
9.5.1	ALARMS AND OTHER DISPLAY LISTS.....	125
9.6	TROUBLE SHOOTING	129
9.6.1	SPECIAL PARTS.....	129
9.6.2	CIRCUIT BLOCK TO BE REPAIRED	129
Chapter 10	AFTER-SALE SERVICE.....	130
10.1	KEEPING PERIOD OF MAINTENANCE PARTS.....	130
10.2	WHEN YOU REQUEST FOR REPAIR.....	130
10.3	RECOMMENDED MAINTENANCE.....	130
10.4	RADAR FAILURE CHECK LIST	131
Chapter 11	DISPOSAL	132
11.1	DISPOSAL OF THE UNIT.....	132
11.2	DISPOSAL OF USED MAGNETRON.....	132
11.3	CHINA ROHS	132
Chapter 12	SPECIFICATIONS	133
12.1	SCANNER DIMENSION	133
12.1.1	NKE-1066.....	134
12.1.2	NKE-2044.....	135
12.2	DISPLAY DIMENSION	136
12.2.1	NCD-2256	136
12.3	EQUIPMENT OUTLINE.....	138
12.3.1	CONFIGULATION	138
12.3.2	FEATURE	138
12.3.3	RADAR MODEL	138
12.4	GENERAL SPECIFICATIONS	139
12.5	SCANNER	140
12.5.1	SCANNER (NKE-1066) SPECIFICATION.....	140
12.5.2	SCANNER (NKE-2044) SPECIFICATION.....	141
12.6	DISPLAY.....	142

CONTENTS

12.6.1	INTEGRATED DISPLAY UNIT (NCD-2256).....	142
12.6.2	OPERATIONAL PART	143
12.6.3	AIS FUNCTION (STANDARD BUILT IN).....	144
12.6.4	TT FUNCTION (STANDARD BUILT IN).....	144
12.7	INPUT/ OUTPUT SIGNAL.....	144
12.7.1	INPUT ENABLE SIGNAL	144
12.7.2	OUTPUT POSSIBLE SIGNAL.....	145
12.7.3	STANDARD CONFIGURATION	145
12.7.4	OPTION CABLE	145
APPENDIX	A-1
	NKE-1066 (1.5FT) SCANNER INTERCONNECTION DIAGRAM	A-1
	NKE-2044 (2FT) SCANNER INTERCONNECTION DIAGRAM	A-2
	NCD-2256 DISPLAY UNIT INTER CONNECTION DIAGRAM.....	A-3
	JMA-1030 PRIMARY POWER SUPPLY DIAGRAM.....	A-4
	JMA-1030 INTERCONNECTION DIAGRAM	A-5
	OPERATION SHEET	A-7
	MENU FUNCTION LIST.....	A-8
	EU DECLARATION OF CONFORMITY	A-16

GLOSSARY

This section describes the main terms used for this equipment and general related maritime terms.

A

Activated target	A target representing the automatic or manual activation of a sleeping target for the display of additional information.
AIS	Automatic Identification System A system which enables ships and shore stations to obtain identifying and navigation information about other ships at sea, using an automated transponder.
Anti-clutter rain	Rain/snow clutter suppression.
Anti-clutter sea	Sea clutter suppression.
AZ	Acquisition/Activation zone A zone set up by the operator in which the system should automatically acquire radar targets and activate reported AIS targets when entering the zone.
AZI	Azimuth stabilization mode

B

BCR/BCT	Bow Crossing Range and Bow Crossing Time
Beacon	In this manual it means radio station that is already known accurate position. DGPS use to calculate for higher accuracy than GPS.
Bft.	Beaufort scale 0: Calm, 1: Light air, 2: Light breeze, 3: Gentle breeze, 4: Moderate breeze, 5: Fresh breeze, 6: Strong breeze, 7: High wind, 8: fresh gale, 9: Strong gale, 10: Storm, 11: Violent storm, 12: Hurricane

C

C up	Course up Own ship's course is pointed to the top center of the radar display.
CCRP	The Consistent Common Reference Point A location on own ship, to which all horizontal measurements such as target range, bearing, relative course, relative speed, CPA or TCPA are referenced, typically the conning position of the bridge.
Clutter	Unwanted reflections on a radar screen, from sea surface, rain or snow.
COG	Course Over Ground The direction of the ship's movement relative to the earth, measured on board the ship, expressed in angular units from true north
Compass	A device indicates the direction.
CORREL	Correlation
CPA/TCPA	The distance to the Closest Point of Approach and Time to the Closest Point of Approach. Limits are set by the operator and are related to own ship.
CTW	Course Through Water The direction of the ship's movement through the water

D

DGPS	Differential Global Positioning System
DRIFT	The current velocity for manual correction or the current speed on the horizontal axis of the 2-axis log is displayed.

E

EBL	Electronic Bearing Line An electronic bearing line originated from own ship's position.
ENH	Enhance
ETA	Estimated Time of Arrival

F

fm	fathom 1fm=1.8288m
FTC	Fast Time Constant Function of FTC reduces the effect of long duration returns that come from rain or snow.

G

GPS	Global Positioning System GPS is a space-based satellite navigation system that provides location and time information in all weather conditions.
Ground stabilization	A display mode in which speed and course information are referred to the ground, using ground track input data.
Gyrocompass	A gyrocompass is non-magnetic compass which is based on a fast spinning disc and rotation of the Earth to automatically find north and south direction.

H

HDG	Heading The horizontal direction that the bow of a ship is pointing at any instant, expressed in angular units from a reference direction.
HDOP	Horizontal Dilution of Precision The accuracy of the position. If the value is small, the accuracy of position is high.
HL	Heading line A graphic line on a radar presentation drawn from the consistent common reference point to the bearing scale to indicate the heading of the ship
H up	Head up Own ship's heading line is always pointed to the top center of the radar display.

I

IR	Radar Interference Rejecter
----	-----------------------------

L

LL	Latitude/ Longitude coordinate system
Log	A device measures the speed through the water.
Lost AIS target	A target symbol representing the last valid position of an AIS target before the reception of its data was lost, or its last dead-reckoned position.
Lost tracked target	One for which target information is no longer available due to poor, lost or obscured signals.
LP	Long Pulse

M

MMSI	Maritime Mobile Service Identity
MOB	Man Over Board
MP	Medium Pulse

N

NM	1NM=1852m
NMEA	National Marine Electronics Association
NSK	North Stabilization Kit
N up	North up The north is always pointed to the top center of the radar display.

O

Own track	Display function of own ship's track
-----------	--------------------------------------

P

PI	Parallel Index line
Past positions	Equally time-spaced past position marks of a tracked or AIS target and own ship.
POSN	Position
PRF	Pulse Repetition Frequency The number of radar pulses transmitted each second.
PROC	Process Radar signal processing function

R

Radar	Acronym for RAdio Detection And Ranging
Radar beacon	A navigation aid which responds to the radar transmission by generating a radar signal to identify its position and identity
Radar cross-section	Radar cross-section of a target determines the power density returned to the radar for a particular power density incident on the target
Range Rings	A set of concentric circles labeled by distance from CCRP.
Reference target	A symbol indicating that the associated tracked stationary target is used as a speed reference for the ground stabilization
Relative course	The direction of motion of a target relative to own ship motion
Relative speed	The speed of a target relative to own ship's speed data
Relative vector	A predicted movement of a target relative to own ship's motion
RM	Relative Motion A display on which the position of own ship remains fixed, and all targets move relative to own ship.
RM(R)	Relative Motion. Relative Trails.
RM(T)	Relative Motion. True Trails.
ROT	Rate of Turn Change of heading per time unit.
Route	A set of waypoints.
RR	Range Rings

S

SART	Search And Rescue Transponder Radar transponder capable of operating in the 9GHz band
SBAS	Satellite-Based Augmentation System Generic technique for correcting the error of the GPS using the geostationary satellite This is used for the positioning accuracy of GPS higher.
Sea stabilization	A display mode in which speed and course information are referred to the sea.
Sea state	Status of the sea condition due to the weather environment, expressed as a sea state 0 for flat conditions with minimal wind, to sea state 8 for very rough sea conditions.
SET	The current direction for manual correction or the current speed on the horizontal axis of the 2-axis log is displayed.
Sleeping AIS target	A target indicating the presence and orientation of a vessel equipped with AIS in a certain location.
sm	Statute mile 1sm=1609.344m
SOG	Speed Over the Ground The speed of the ship relative to the earth, measured on board of the ship.

GLOSSARY

SP	Short Pulse
STAB	Stabilization
STC	Sensitivity Time Control Function of STC reduces the impact of returns from sea state of relatively near from own ship.
STW	Speed Through Water The speed of the ship relative to the water surface.

T

TCPA	Time to Closest Point of Approach to own ship
Test target	Radar target of known characteristics used for test requirement
TM	True Motion A display across which own ship moves with its own true motion.
Trails	Display Radar Trails (Other Ships' Trails)
True course	The direction of motion relative to ground or to sea, of a target expressed as an angular displacement from north
True speed	The speed of a target relative to ground, or to sea
True vector	A vector representing the predicted true motion of a target, showing course and speed with reference to the ground or sea
TT	Target Tracking A computer process of observing the sequential changes in the position of a radar target in order to establish its motion. Such a target is a Tracked Target.
TTG	Time To Go Time to next waypoint.
TXRX	Transceiver Unit

U

UTC	Universal Time Coordinated The international standard of time, kept by atomic clocks around the world.
USB	Universal Serial Bus USB was designed to standardize the connection of computer peripherals.

V

VRM	Variable Range Marker An adjustable range ring used to measure the distance to a target.
-----	---

W

Waypoint	A geographical location on a route indicating an event
----------	--

Chapter 1 INSTALLATION

1.1 OVERVIEW

The proper installation of the radar equipment is critical in ensuring its effective and reliable performance as well as facilitating maintenance and repair. Carefully install the radar equipment by following the procedures below.

- Considering the weight of the scanner unit and install it in a high place as possible.
- It is preferable to install the display unit in the wheel house to facilitate observations.
- Available cable lengths and types for installing the radar JMA-1030 are as shown in the table below. Request an appropriate cable from JRC beforehand.

A cable longer than the sufficient length may degrade radar performance, so give it careful consideration when planning the installation.

10m cable is the standard configuration.

Installation Cable

Type Name: CFQ9924-10

Length: 10m (8core)

Standard Supply



CFQ9924-5	5m (8 core)	*Option
CFQ9924-15	15m (8 core)	*Option
CFQ9924-20	20m (8 core)	*Option
CFQ9924-30	30m (8 core)	*Option

Power Supply Cable

Type Name: CFQ-9900

Length: 2m

Standard Supply

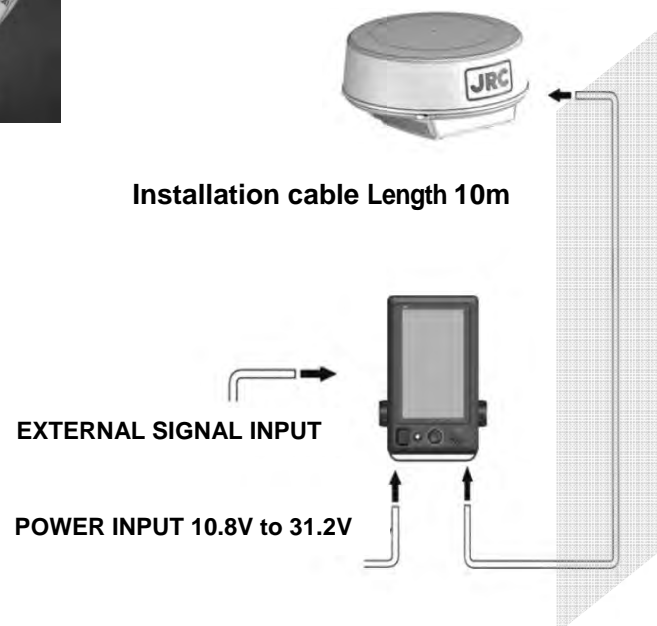

1.2 INSTALLATION OF THE DISPLAY UNIT

1.2.1 SELECTING THE INSTALLATION POSITION

Select the display unit installation position by taking into consideration of the followings.

- Install the display unit so that the user can easily conduct observations.
- To reduce affect on the magnetic compass, install the display unit more than 1 meter away from the compass.
- Take precautions to prevent water from splashing through the window or door of the bridge onto the display unit.
- Install the display unit by considering convenience of maintenance.
- Install the display unit so that when the user is looking ahead, the lookout view is not obscured.
- Install the unit away from direct sunlight and heat source.

1.2.2 SELECTION OF DISPLAY MOUNTING

Display is designed to various mounting way for users circumstance.

Mounting way.

- Desktop Installation
- Flush Mounting
- Ceiling Installation (The attachment tool is option)

1.2.3 DIMENSIONAL DRAWING OF DISPLAY MOUNTING

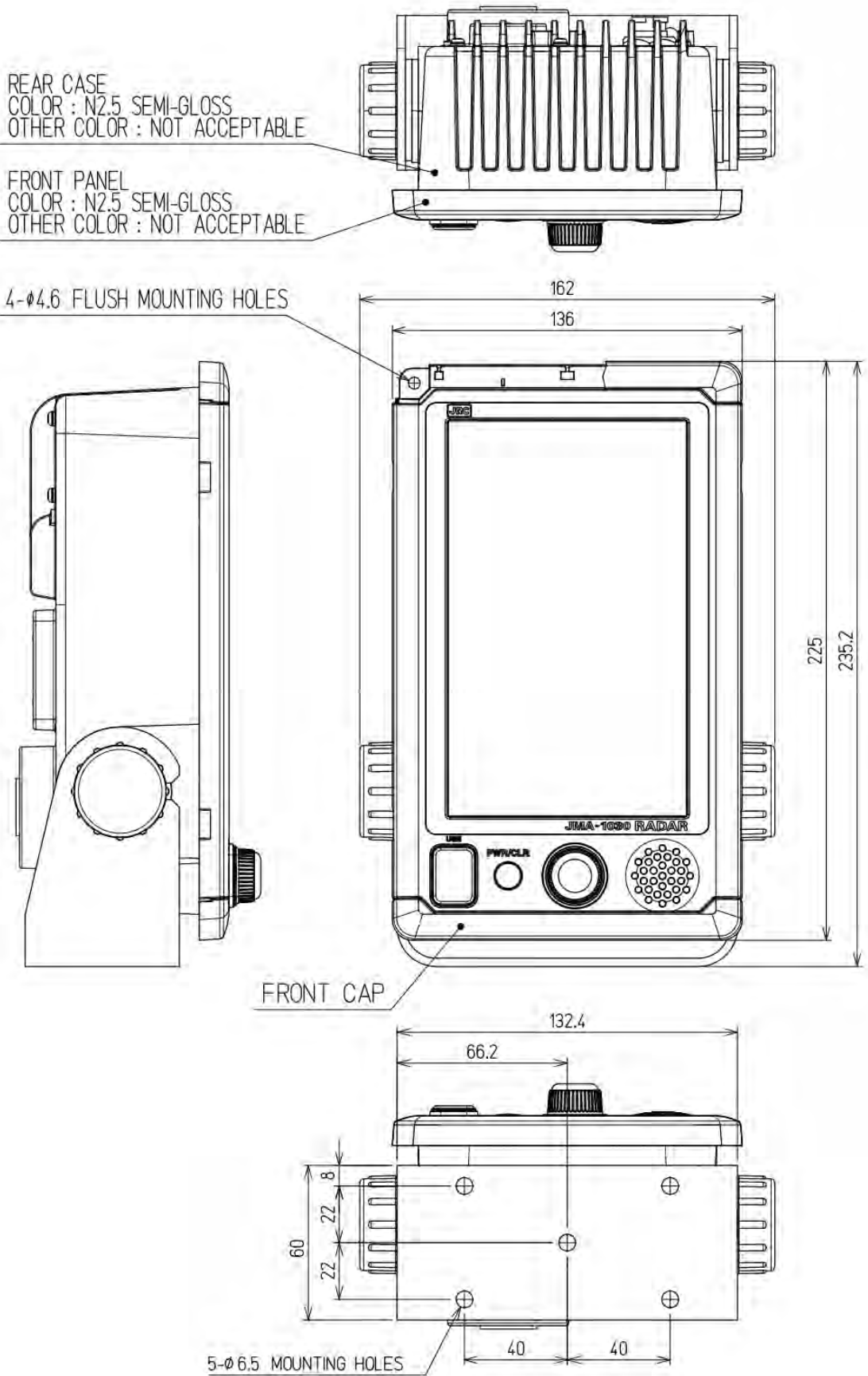

OUTLINE DIMENSIONS		PERMISSIBLE OUTLINE DIMENSIONAL DEVIATIONS	PERMISSIBLE MOUNTING DIMENSIONAL DEVIATIONS
OVER	TO		
3	6	±0.5	±0.5
6	30	±1	
30	120	±1.5	±1
120	400	±2.5	
400	1000	±4	±2

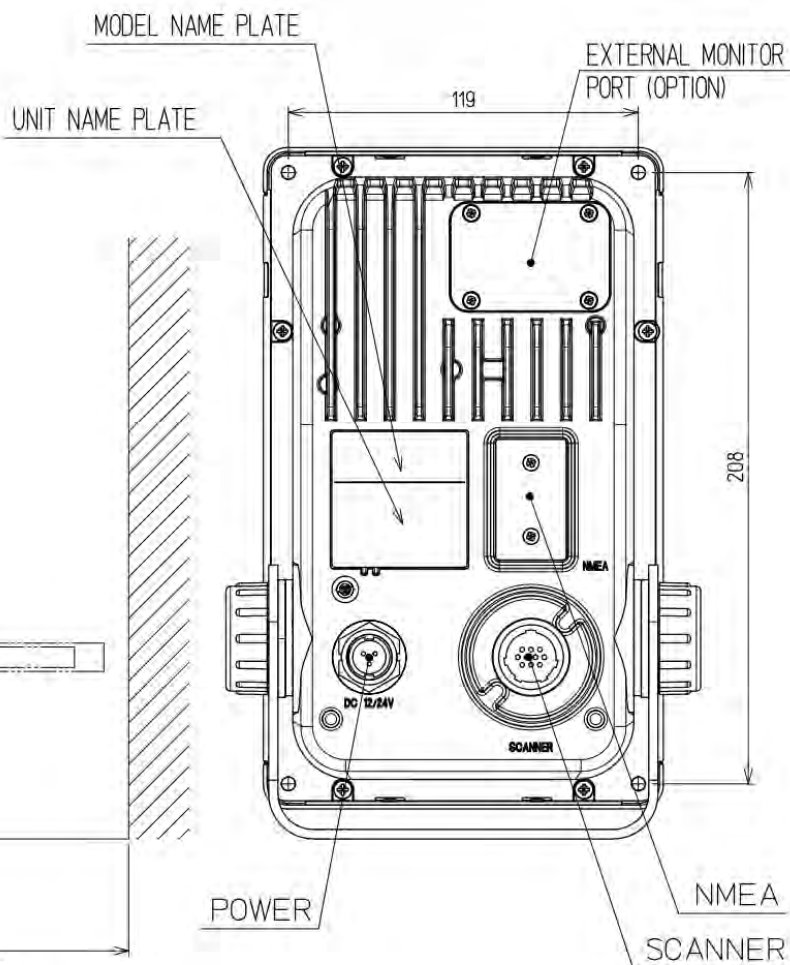
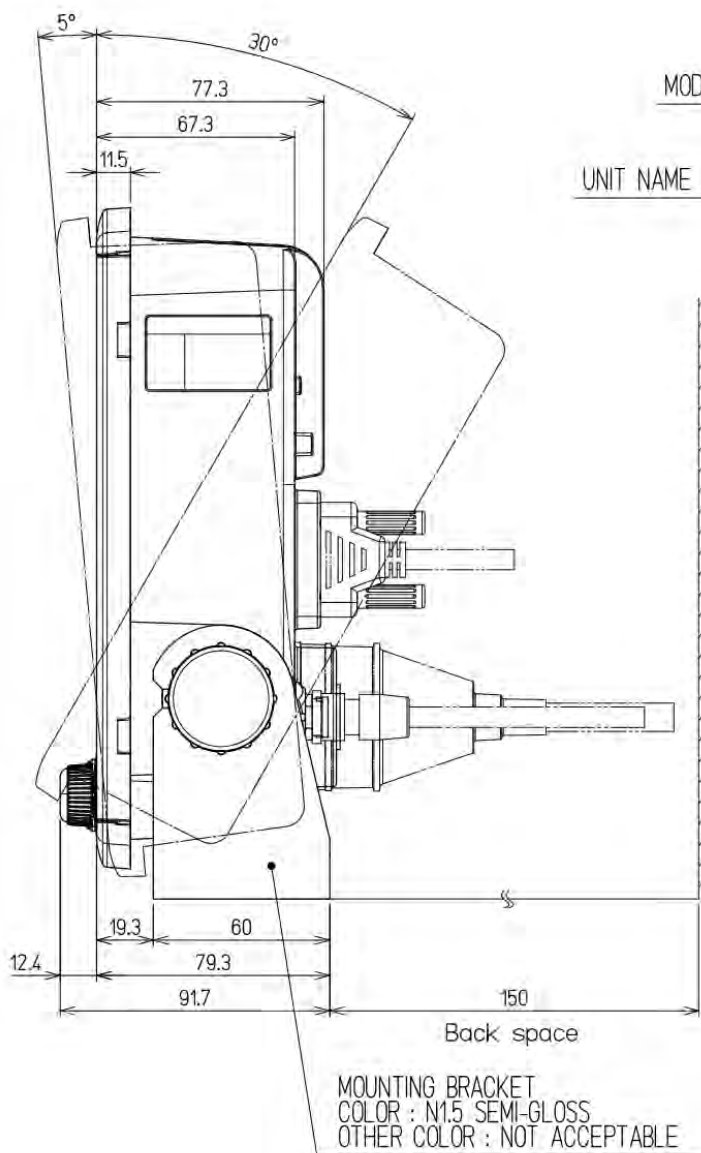

1.2.4 EXAMPLES OF DISPLAY MOUNTING

■ DESK TOP INSTALLATION



Mounting bracket

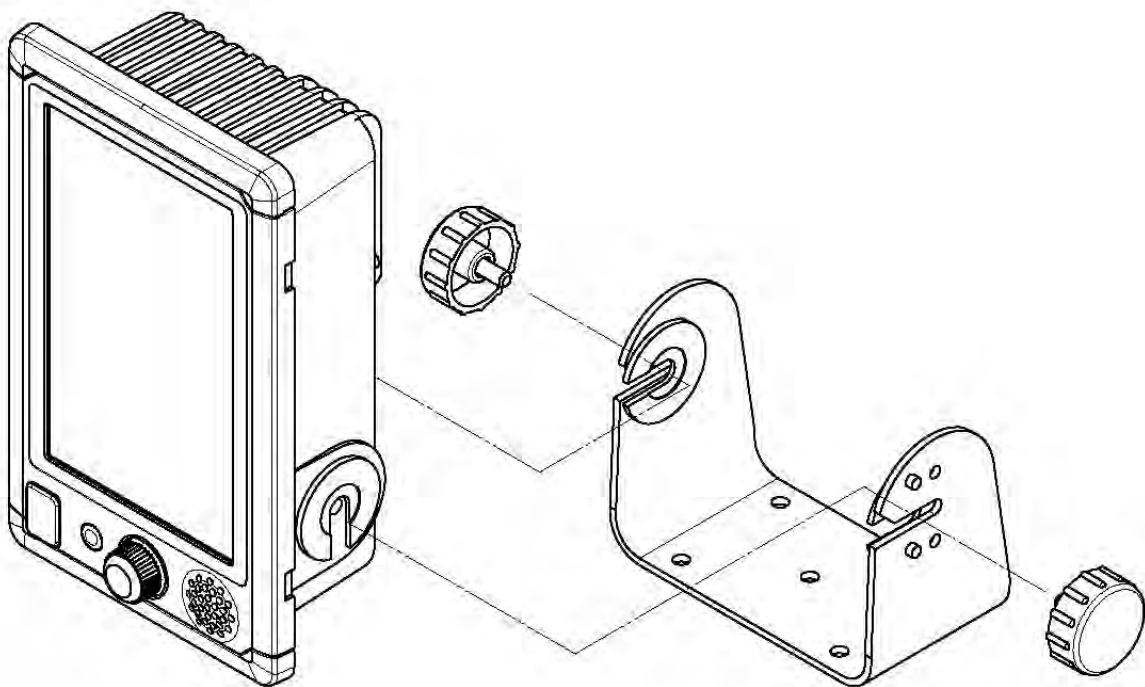

■ DESKTOP MOUNTING TEMPLATE

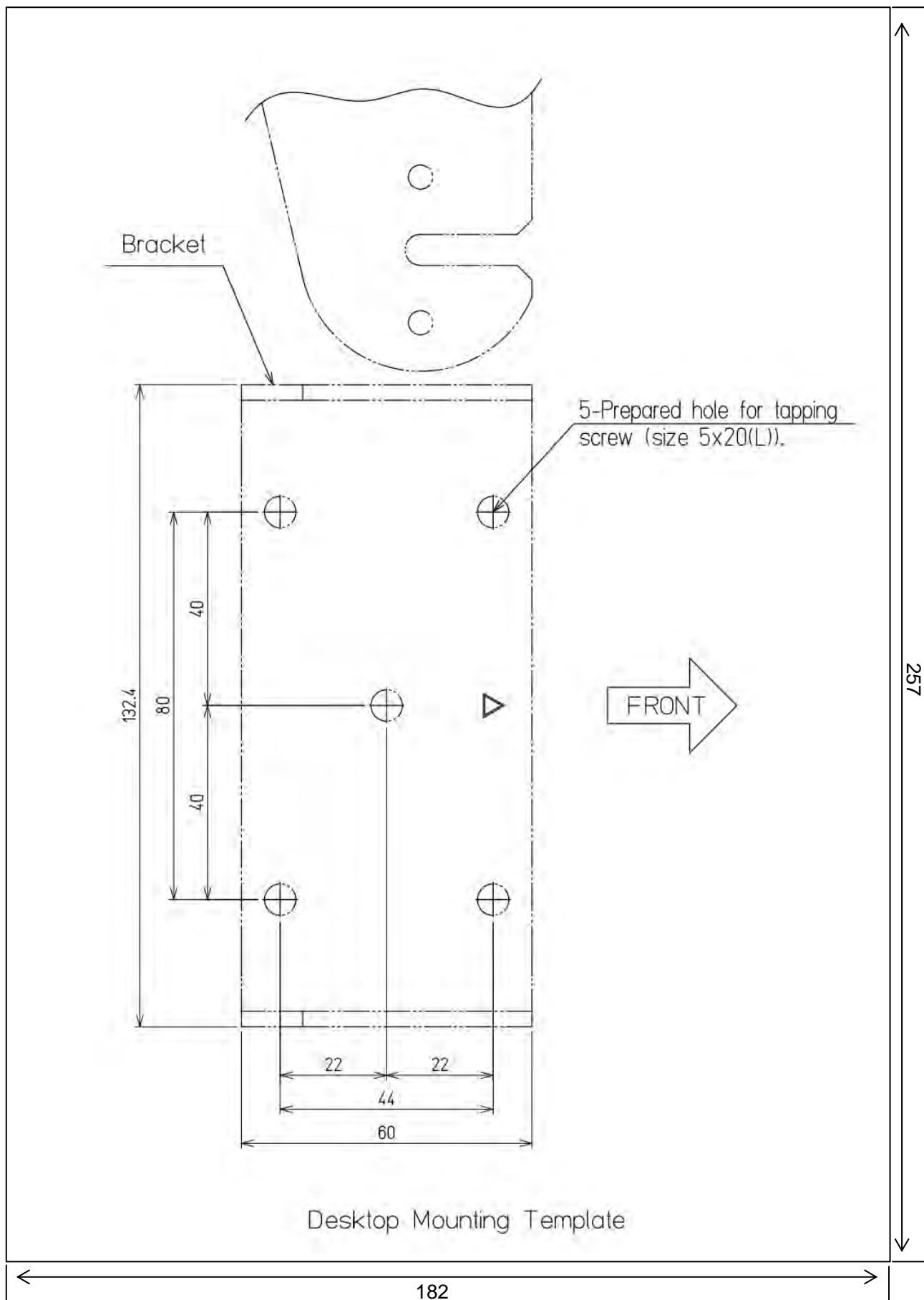

Note: Please note the paper size.

■ FLUSH MOUNTING

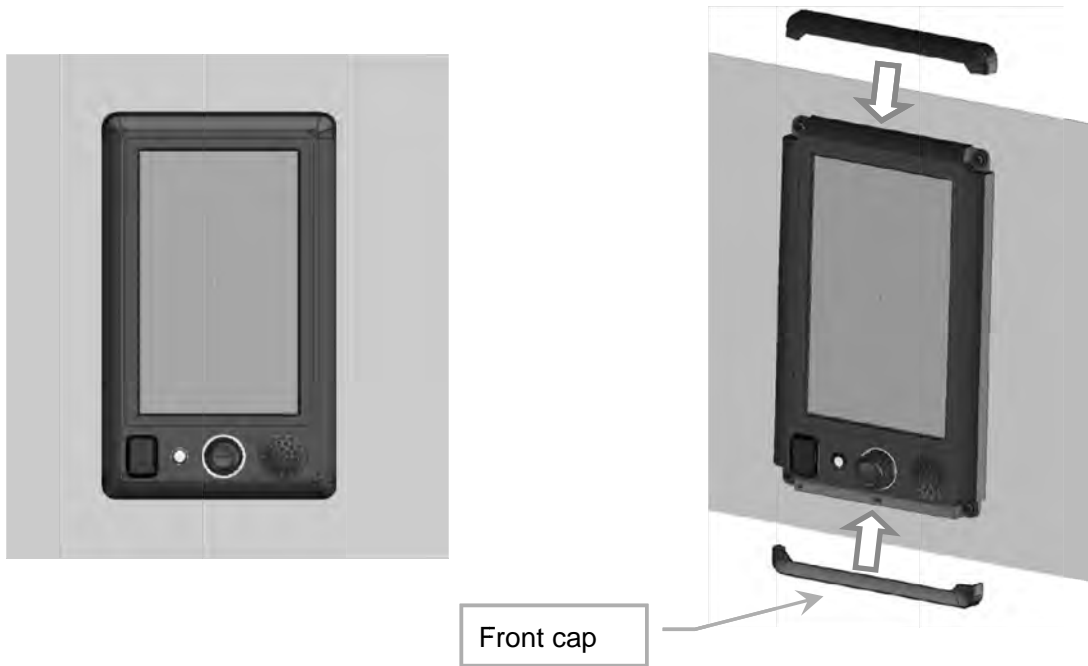

Note: Please slide out, when removing of the front cap.

Flush mount:

Remove base, and take out cover of front panel

Fix with the front 4 corner screws to the wall.

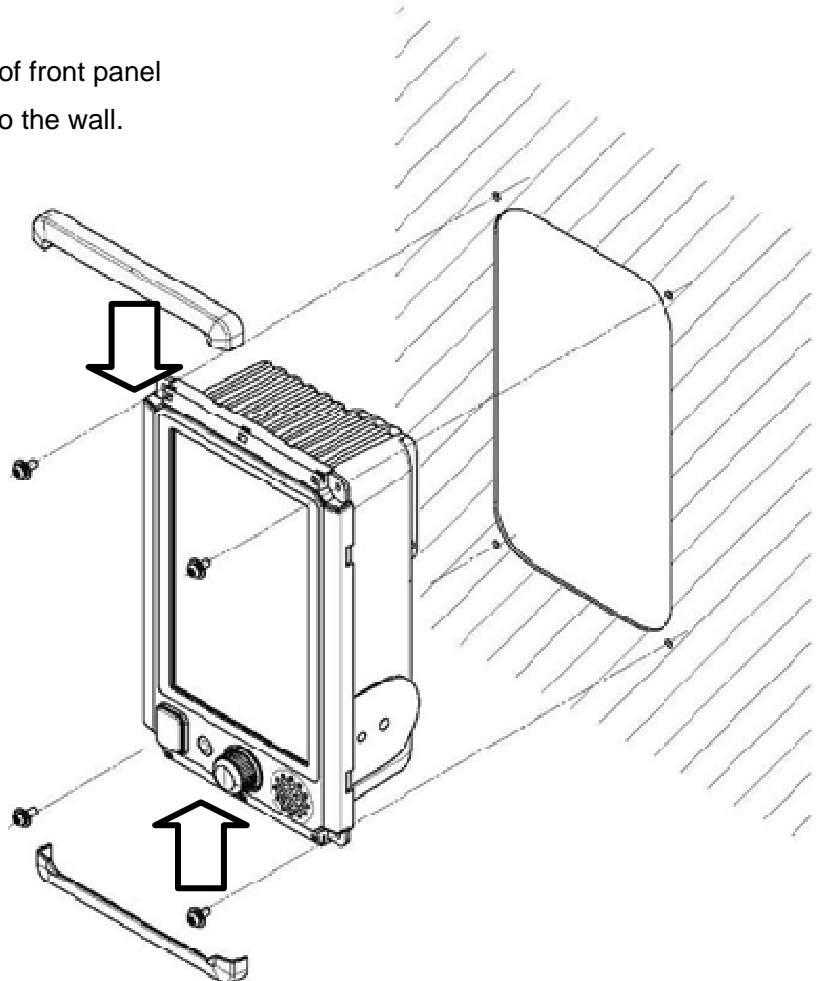

■ FLUSH MOUNTING TEMPLATE

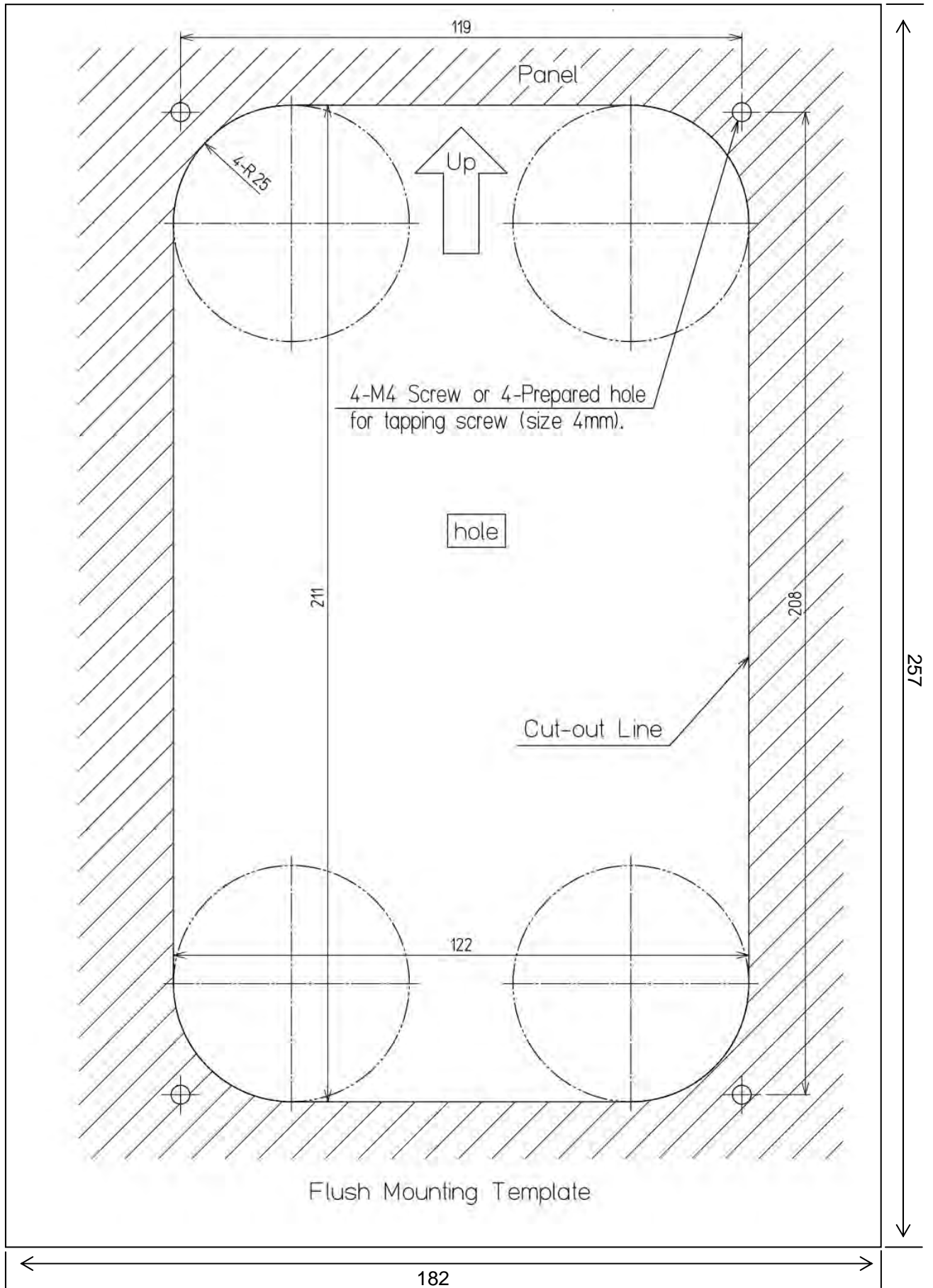

Note: Please note the paper size.

■ CEILING INSTALLATION

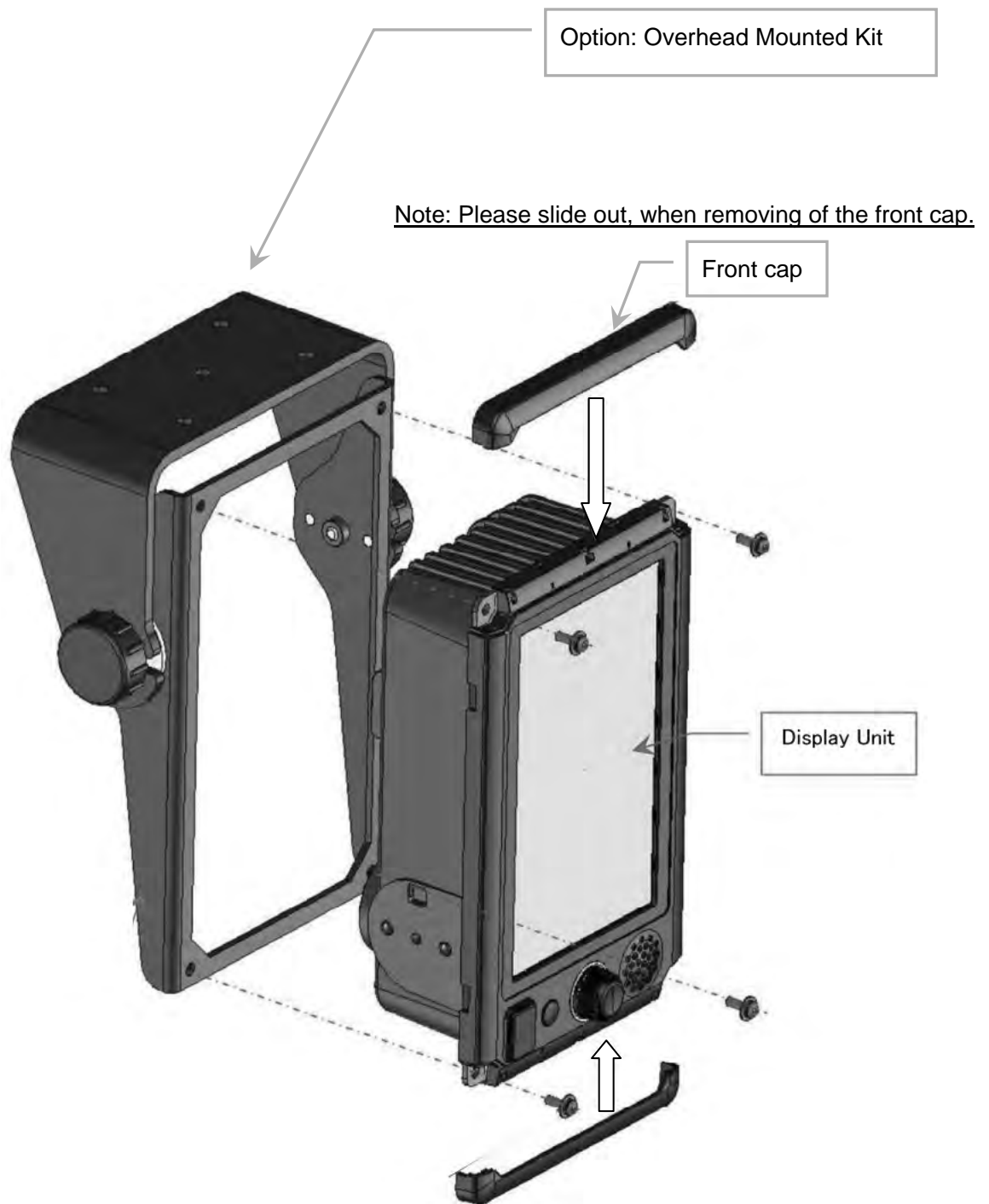

1.2.5 POWER CABLE INSTALLATION

This equipment includes a 2m power cable for power supply to the display unit.

Cable assembly name: CFQ-9900

The cable core wire color is red (+), black (-), shield mesh and green (frame ground).

Wire : AWG16

Red:	+12/24V
Black:	0V
Shield + Green:	FG (frame ground)

The fuse box is built into the cable (red line side).

In the case of fuse blown, please replace it with the spare parts.

Fuse: 58V/7.5A

CAUTION



When you connect with the ship power supply without using the optional rectifier, you need measure the voltage between the ground and the positive / negative side of the ship power supply.

When the ship power supply is more than 38V, please take through measures such as attaching a rectifier.

If you connect to the ship power supply directly without taking any measures, there is a risk of system failure or accident occur.

■ Power Cable Installation

Connect the power cable (CFQ-9900) to the power input connector of display unit. At that time, please turn to the right the tip locking mechanism to lock the position of the connector.

1.2.6 EXTERNAL NAVIGATIONAL SIGNAL CONNECTION

(GPS, AIS, GYRO, LOG, etc.) Connecting cable is option

Option NMEA cable: H-7ZCRD1689*

In case of using option NMEA cable, waterproofing (IPX5) is guaranteed. Thus using another NMEA cable, waterproofing (IPX5) is not guaranteed.

- Using JRC GPS receiver, please connect NMEA1.
- Using JRC NSK, please connect NMEA3.
- AIS connects all NMEA port available.

Navigation system interfaces, such as GPS

Telecommunications standard NMEA0183 / IEC61162-1/2 conformity

Communications protocol: 4800 bps, start 1bit, data 8bit, stop 1bit, and no parity
 Input sentence NMEA0183: V1.5: GGA/GLL/RMC
 V2.0: GGA/GLL/RMC/ZDA
 V2.3: GGA/GLL/RMC/GNS/ZDA

(Talker= "G P" etc.)

Information ship position and the time; GGA/GNS/GLL/RMC

Day ZDA/RMC

Time of equipment: ZDA/GGA/GNS/GLL/RMC

Reference :

NMEA0183 content outline of standard input / output sentence

\$xxACK	Acknowledgement alarm
\$xxBWC	Bearing and Distance to Waypoint
\$xxCUR	Water current layer
\$xxGGA	Global Positioning System Fix Data
\$xxGLL	Geographic Position - Latitude/Longitude
\$xxGNS	GNSS fix data
\$xxMTW	Water temperature
\$xxMWD	Wind direction and speed
\$xxMWV	Wind speed and angle
\$xxRMA	Recommended Minimum Specific LORAN-C data
\$xxRMB	Recommended Minimum Navigation Information
\$xxRMC	Recommended Minimum Specific GNSS Data
\$xxROT	Rate Of Turn
\$xxRSA	Rudder Sensor Angle
\$xxTHS	True Heading and Status
\$xxVBW	Dual ground/water speed
\$xxVDM	AIS VHF Data-link Message
\$xxVDO	AIS VHF Data-link Own-vessel report
\$xxVTG	Course Over Ground and Ground Speed
\$xxZDA	Time and Date

1.3 INSTALLATION OF THE SCANNER UNIT

1.3.1 SELECTING THE INSTALLATION POSITION

■ PHYSICAL SELECTION CRITERIA

- Install the scanner at the center of the mast on the keel line.
- If the scanner cannot be installed at the above position for some reason, the amount of deviation must be minimized. And, reinforce the mount base and the platform and take precautions to protect the scanner from vibration and impact at the installation position.
- Please note that not affected by the smoke from the chimney.
- Please secure maintenance spaces (a platform, a safety link, a handrail, a step, etc.).

■ ELECTRICAL SELECTION CRITERIA

- The installation height of the scanner relates to the maximum detection distance. The higher, the better. However, if it is too high, radio wave energy greatly attenuates above the scanner's vertical beam width (the point -3 dB from the peak of the main-lobe). As a result, it is difficult to detect a close-in target. Sea clutter also increases. Determine the installation height by taking into consideration the weight, maximum length of the cable, and maintenance after installation. If the installation height of the scanner is low, it is difficult to detect a long distance target. The ship's mast, derrick, and chimney interfere with radiating beam causing the range that cannot be viewed on the radar display to increase.

1.3.2 LOWEST SCANNER INSTALLATION HEIGHT

Generally, the lowest scanner installation position is supposed to be on the A-B line shown in Fig. 1-3-2. In the case of the JMA-1030 series radar, 2θ equals 25° .

Specifically, the scanner position is normally elevated so that the chimney and the shrine-gate type mast do not interfere with radiating beam.

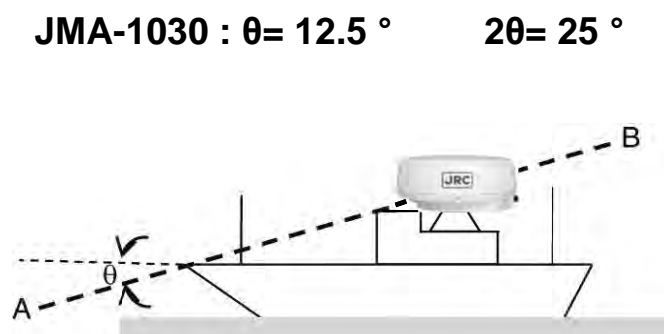

Fig. 1-3-2

1.3.3 MOUNTING RACK AND MAST FOR THE SCANNER

If it is considered that sufficient installation height cannot be provided when the scanner is installed directly on the roof of the wheelhouse, use a mounting rack or radar mast (Fig. 1-3-3).

Normally, when the scanner installation height is less than 2 meters from the roof of the wheelhouse, provide a mounting rack assembled at an angle frame to install the scanner. When the scanner installation height is 2 m or higher from the roof of the wheelhouse, provide a cylindrical radar mast to install the scanner.

Consider the convenience of the service staff who take care of installation, maintenance, adjustment and repair of the scanner by providing adequate footholds to the mounting rack and the radar mast.

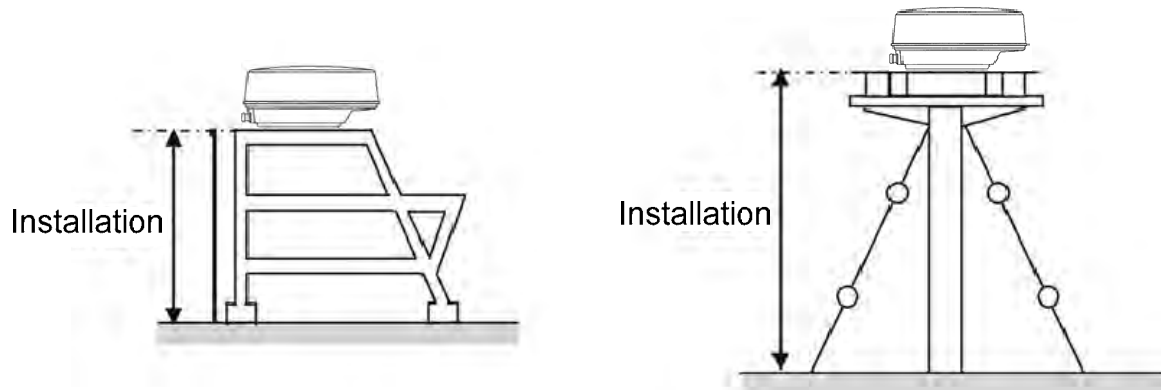

Fig. 1-3-3

1.3.4 SCANNER AND THE SURROUNDING STRUCTURAL OBJECTS

When installing the scanner, select a location where there are the fewest structural objects in the surrounding area so that false images which interfere with target detection will not be generated by signal reflection from other scanners, deck structures, and cargo

Only as a guide, note that structural objects should not exist within the range of the vertical beam width (Fig. 1-3-4).

Vertical beam width of X-band: Approx. 25° ($\pm 12.5^\circ$ when the height of the radiating section is 0°).

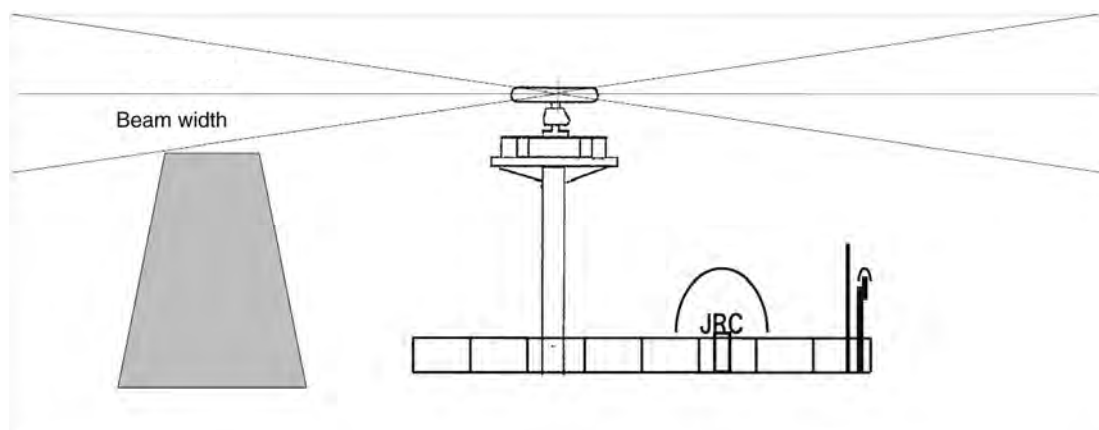

Fig. 1-3-4

When installing two scanners, provide a height difference so that those two scanners do not enter each other's vertical beam width range.

To avoid interference with other equipment and to prevent radio noise from generating, do not place the VHF antenna, GPS antenna, and INMARSAT's dome within the range of the vertical beam width. Keep a record of installation height data. The data is necessary for the initial setting of the display unit.

Magnetron which has strong magnetic force is included in the scanner. Install the scanner at least 3 meters away from nautical instruments including magnetic compasses and chronometers.

1.3.5 ENSURING VIEW ANGLE

Minimize the blind sector, and ensure the adequate view angle so that the blind sector does not exist in the range 22.5° from side to rear (Fig. 1-3-5).

Specifically, ensure a sufficient view field in the straight front (relative bearing 0°).

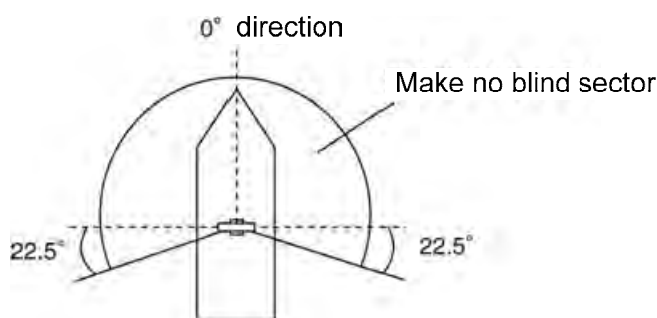

Fig. 1-3-5

Reference:

- If there is a concern that structural objects existing within the vertical beam width may generate false images, equip the structural objects with a radio wave absorber. (There are two types of absorbers: broadband type having no specific resonant frequency and narrowband type which can absorb a band with a specific frequency. Use those where applicable.)
Furthermore, it is effective to install a metal reflector, which reflects radio waves upwardly, between the scanner and a structural object so that the radar's radio wave will not directly come in contact with the structural object
- Because most radio wave absorbers have poor durability, some must be replaced every year.
When installing a reflector, the area to the rear of the reflector becomes a blind sector. Therefore, minimize the size of the reflector.
- The above procedures for selecting a scanner installation position are described based on the radar's scanner. Comprehensively select the scanner position by considering other scanners' installation procedure manual, hull's structure, strength of the selected position, and vibration.

■ Confirmation during test run

If the scanner vibrates a lot during test run, try to reduce or prevent vibration by reinforcing the scanner mount base or using wire stays attached to the radar mast.

■ Others

The design of the mounting platform for the scanner should take into account the vibration requirements defined by IEC 60945.

Vibration

Frequency	2 to 13.2 Hz
	13.2 Hz to 100 Hz
Amplitude	+/-1 mm +/-10 %
Acceleration	7m/s ² constant

- All installations should facilitate protection of equipment, including cabling, from damage.
- The cables should be kept as short as possible to minimize attenuation of the signal.
- Crossing of cables should be done at right angles(90°) to minimize magnetic field coupling.
- Install the radar cable as far as from the cables of other radio equipment in order to prevent other radio equipment from interfering with the radar operations. Especially inter-wiring cables between scanner unit and display unit of the radar should not be run parallel with the cables of other radio equipment.
- Cable should not be exposed sharp bends.
- Ensure that the equipment is grounded.

■ Maintain a flat level surface on which to install the scanner

- Use sufficiently thick steel material and reinforcement material for the scanner's installation surface (mount base) to reduce vibration and impact. Keep the mount base flat and smooth.
- If there is a partial gap between the mount base and the scanner chassis's legs, work on the installation surface so that it becomes flat and smooth, or make adjustments by inserting metal shims.
If a gap exists and the scanner is tightly clamped, the chassis will distort and become damaged by vibration.

■ Avoid using vibration-proof rubber and resin

- Do not insert an elastic body, such as vibration-proof rubber or resin, between the mount base and the scanner chassis legs. If rubber or resin is inserted, the amplitude of vibration increases, resulting in the possibility of damage to the scanner. Furthermore, if installation bolts become loose due to deterioration of rubber or resin, the scanner may be damaged or fall from its mount

1.3.6 CONFIRM MOUNTING BASE BEFORE INSTALL

NKE-1066 1.5FT SCANNER

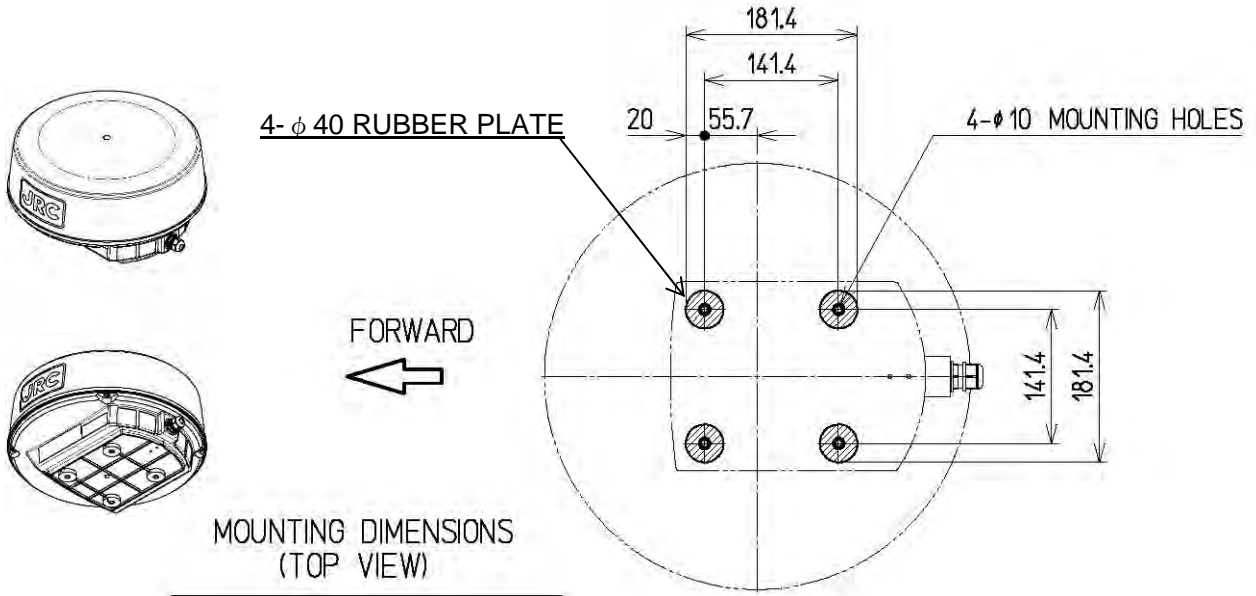

Fig 1-3-6-1

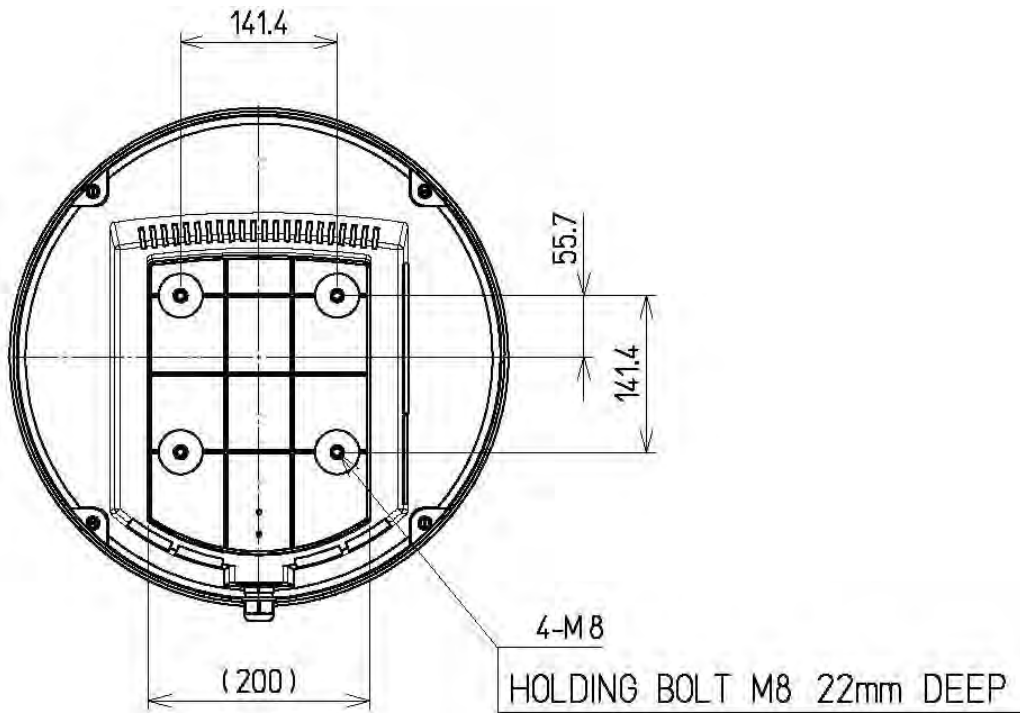

Fig 1-3-6-2

NKE-2044 2FT SCANNER

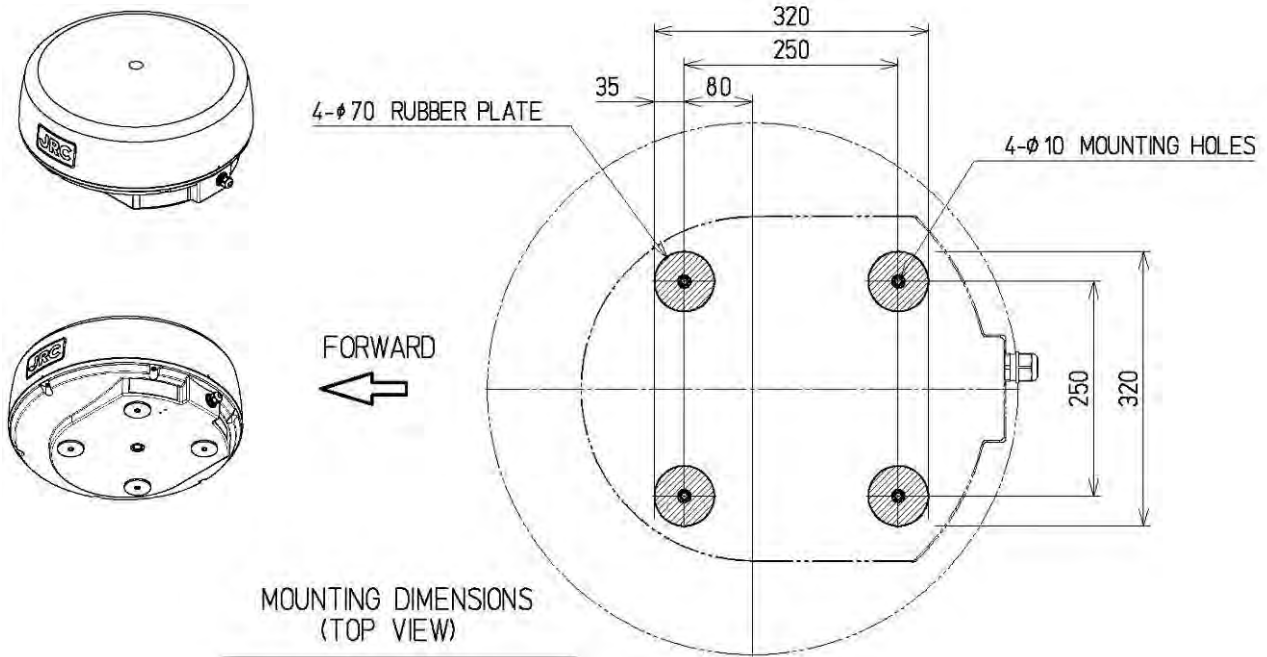

Fig 1-3-6-3

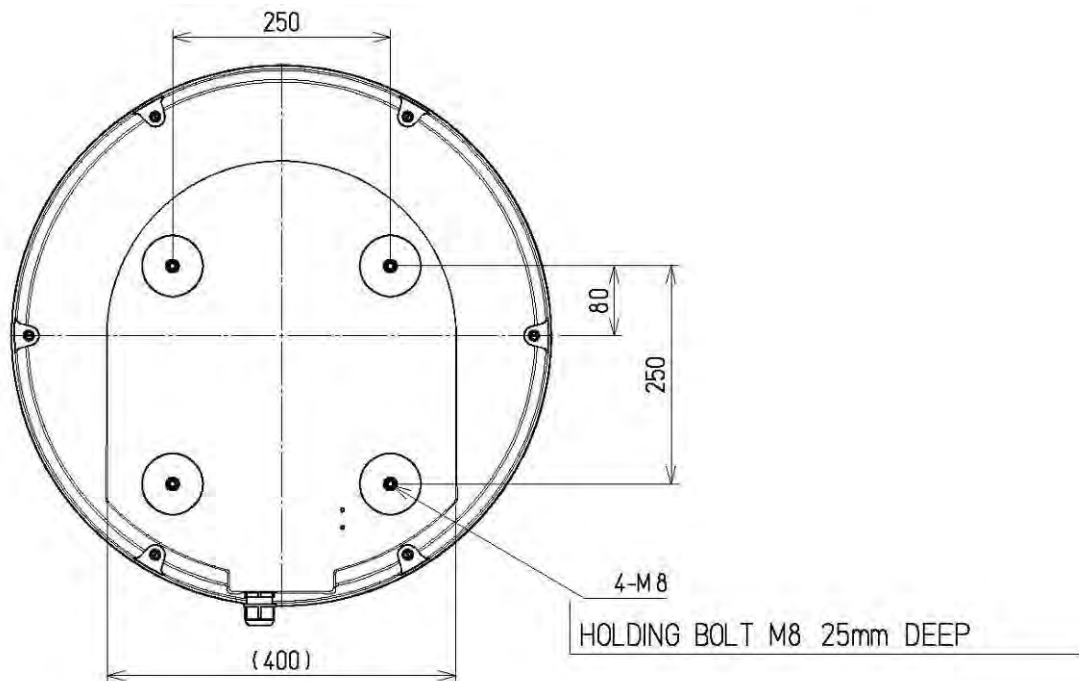

Fig 1-3-6-4

■ Installation and clamping method

■ Installation direction

Installation should be done so that the cable gland is oriented toward the stern.

■ Bolts, nuts and tightening torque to be used

Use stainless steel bolts for the scanner and uniformly tighten all of the bolts (Table 1-3-6-1).

Table 1-3-6-1 Length of scanner mounting bolts and tightening torque

Thickness of Mount Base (mm)	Bolt	Torque (N•m)
3-15 mm (Recommend)	M8X30SUS (attachment)	20 N•m

■ Use of washer and corrosion-resistant measures

At the location where a bolt's head comes in contact with the scanner chassis' legs and the mount base, insert a plain washer and spring washer which fit the bolt; and then securely tighten the bolts. To prevent corrosion due to the contacts between different metals, such as the scanner chassis' legs, installation surface, bolts etc., cover the bolt's head with sealant .

■ Grounding and corrosion-resistant measures

Do not install the scanner in place where puddles are often formed.

1.4 CONNECTING THE INSTALLATION CABLE

With this new radar, JRC introduces two new small and light weight 4kW multi-speed scanners available in a 1.5ft (450mm) and 2ft (620mm) radome.

Both of them are the radome type, so antenna rotation is not affected by wind.

The microwave radiator is also protected by the radome, even in a poor weather conditions, it can be rotated stably at all times.

Remove the radome, then open the metal protection cover, and connect the connector as the following.

■ Display side

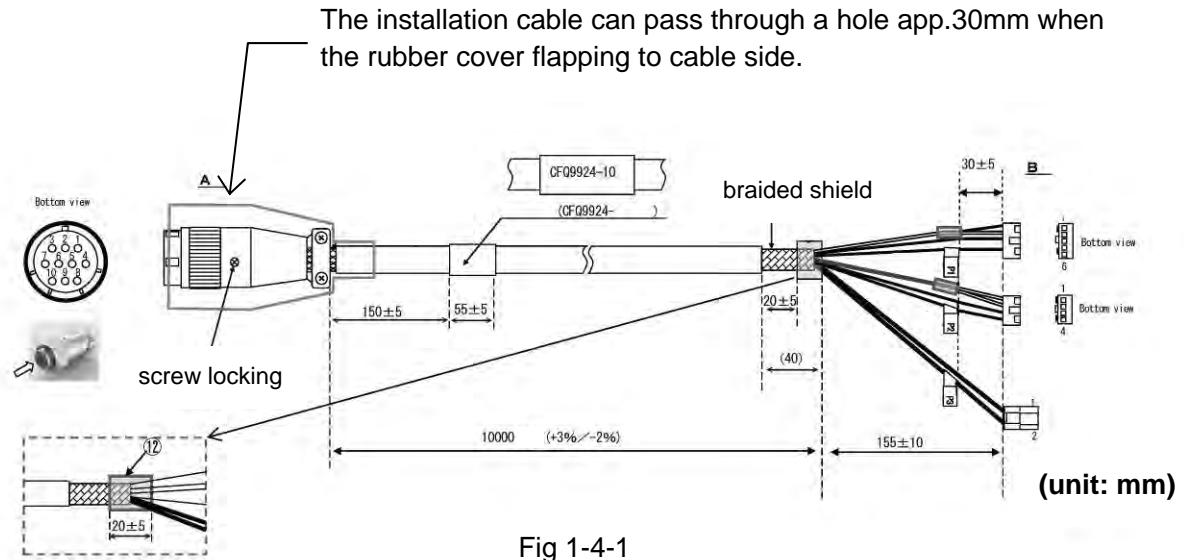

■ Scanner side

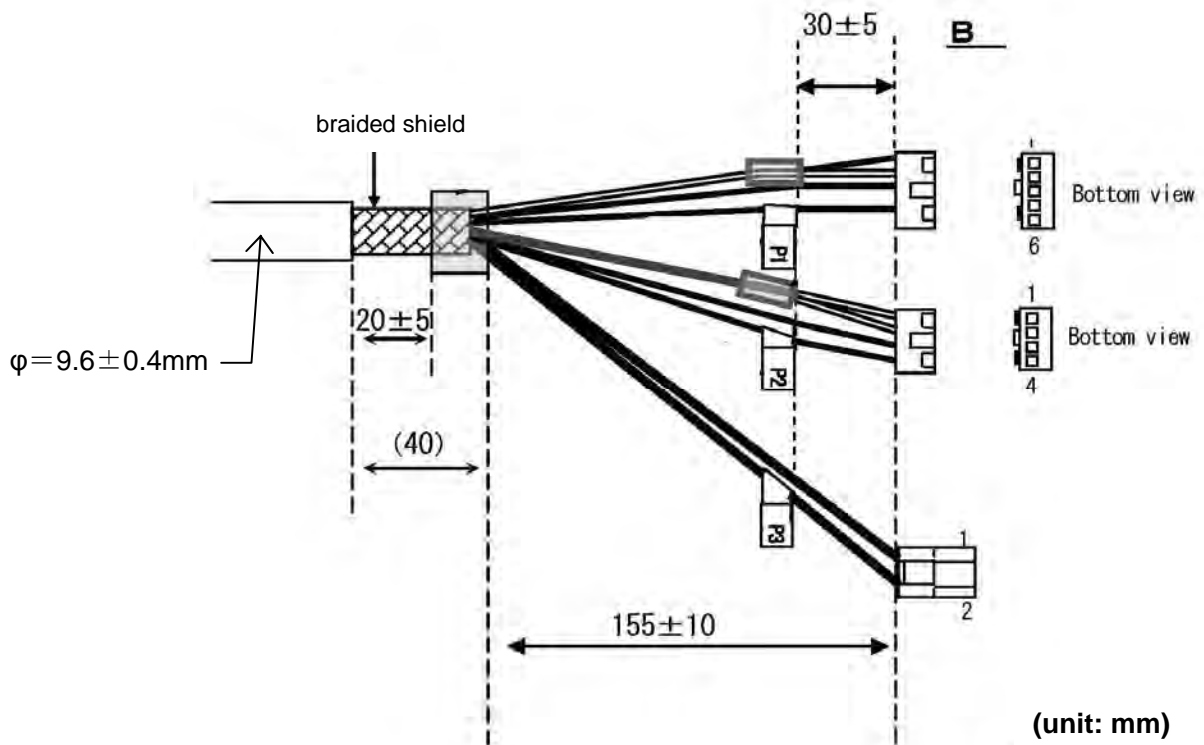

1.4.1 NKE-1066 SCANNER (1.5 FEET)

Set the cable inlet side to face the stern.

The scanner certainly can be placed to face any direction during the initial setting.

However, it is strongly recommended that you install the scanner with the shortest cable length along the mast.



Fig. 1-4-1-1

■ Open radome

Loosen the screws by using box spanner tool, then you can lift up the radome.

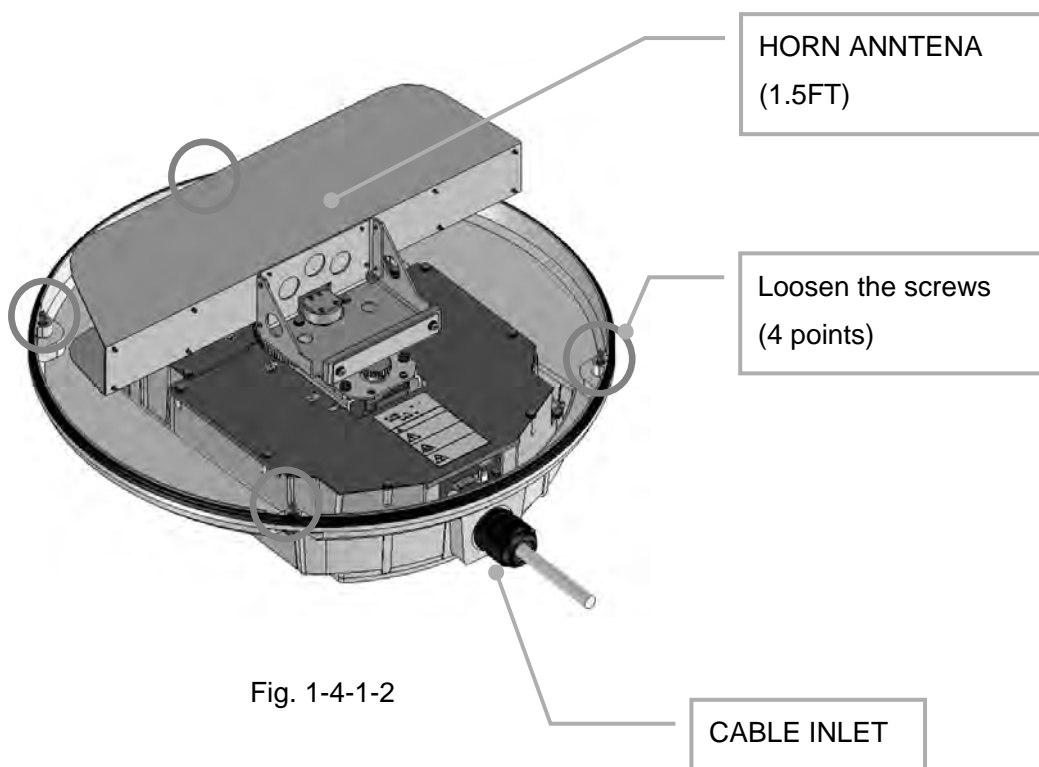
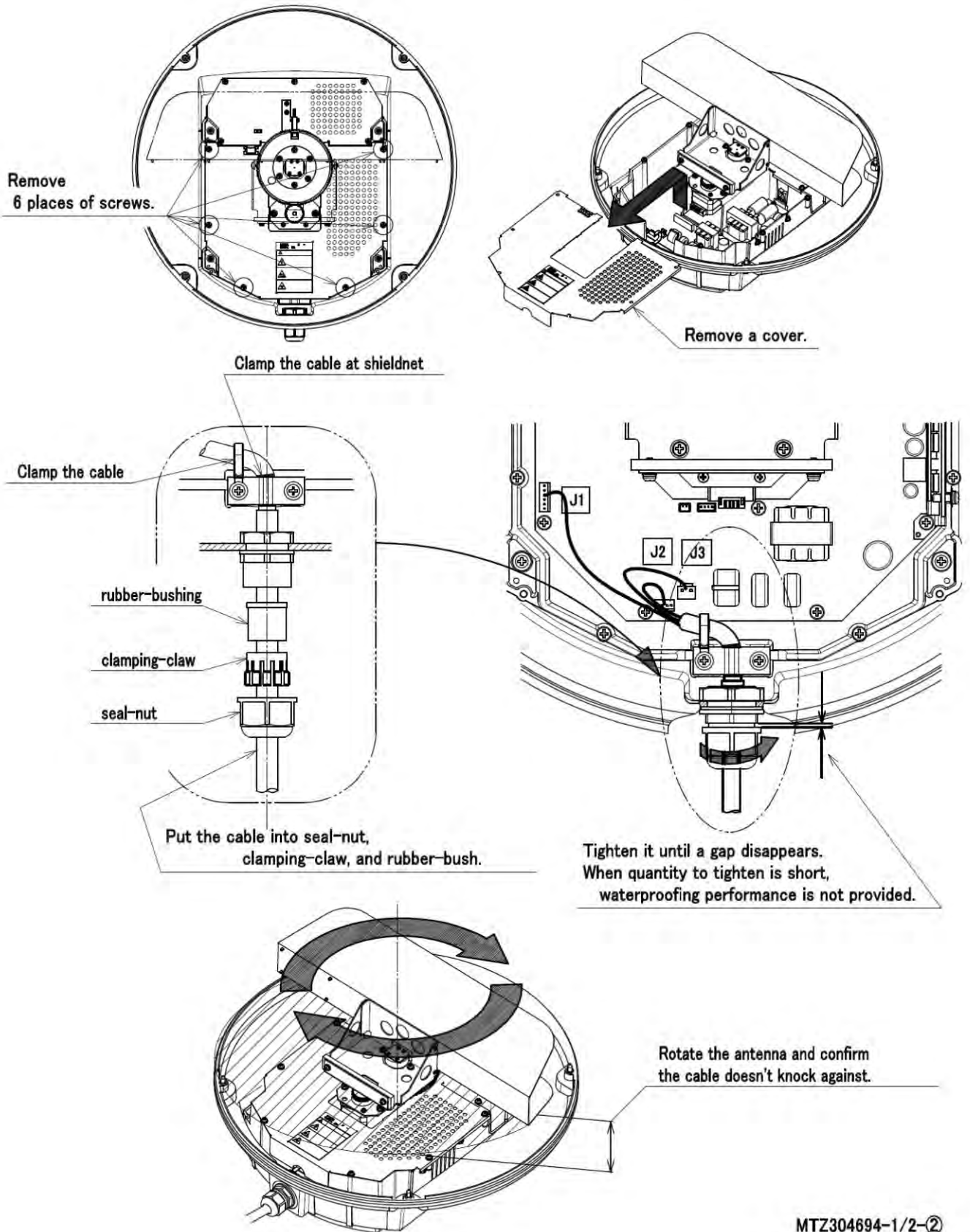

Fig. 1-4-1-2

Instruction for Equipment



MTZ304694-1/2-②

Fig. 1-4-1-3

⚠ CAUTION



When mounting the scanner unit, please check the maximum length of the holding bolts. If the bolts are too long, it gives severe damage to inside of the scanner. When mounting the scanner unit, please use the attached bolts.

The mounting base thickness must not exceed 15mm (0.6inch).

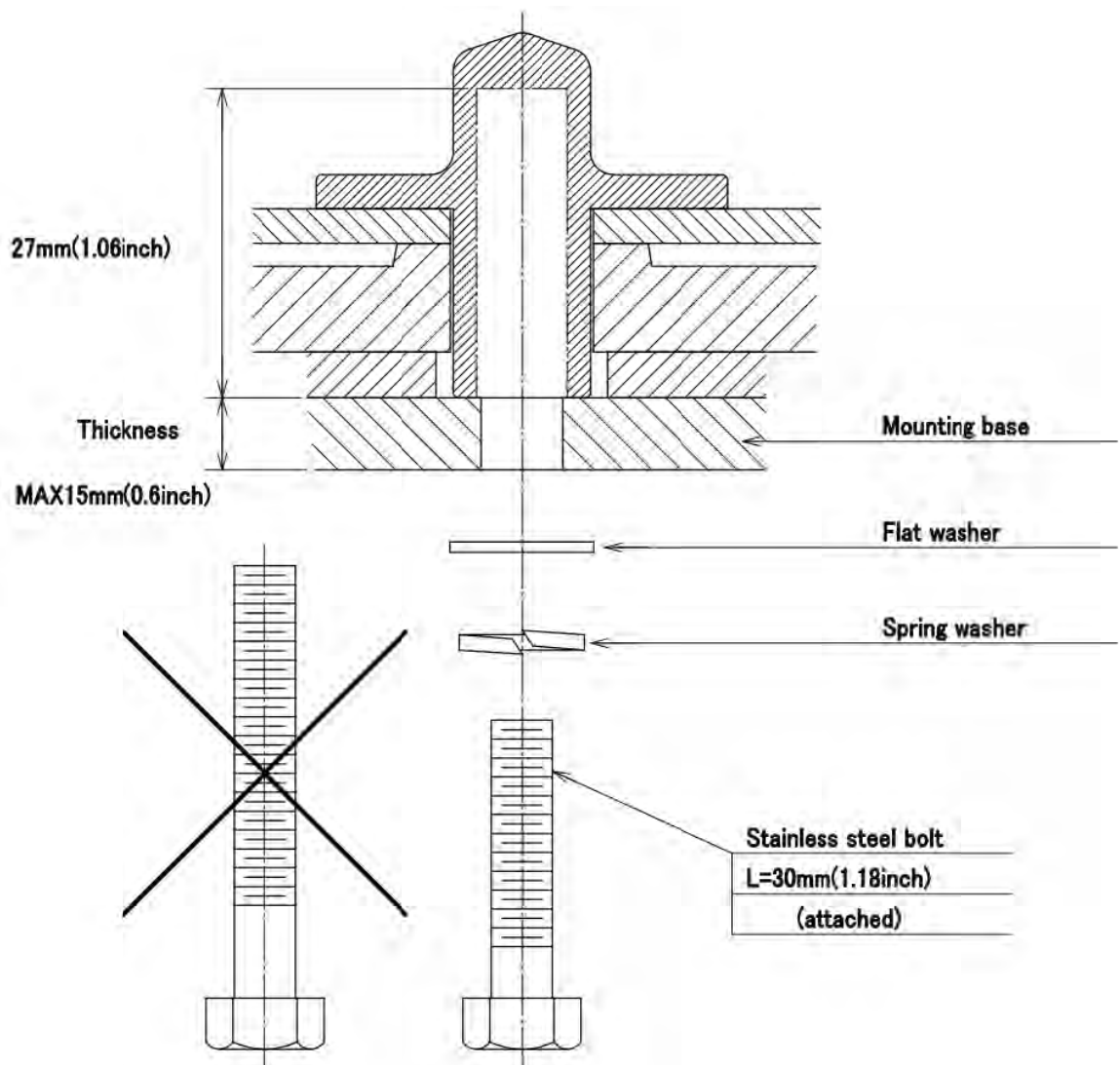

※ FIX THE BOLTS BY USING A STANDARD WRENCH (LENGTH 135mm TORQUE 2058[N•cm])

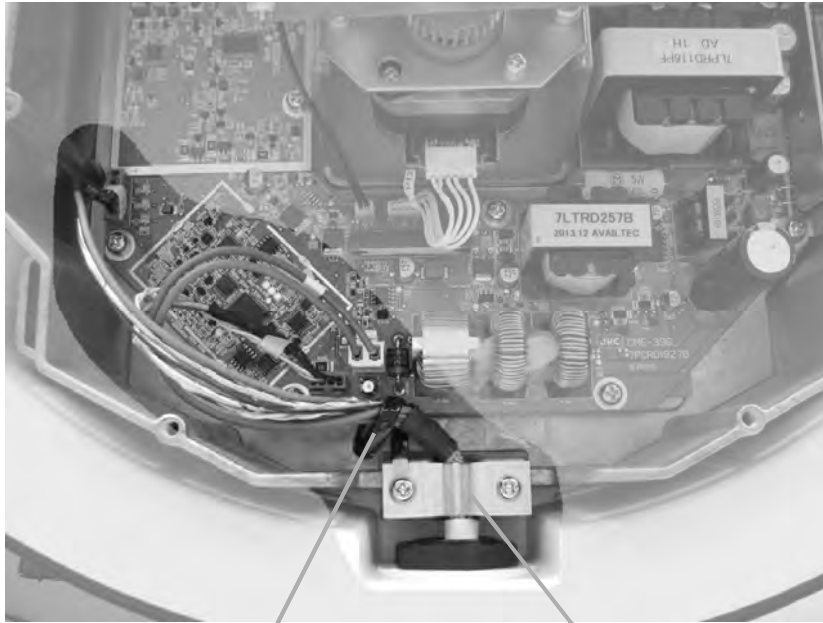

Coating clip

Connect cable mesh wire as Ground.

Pull and fix the cable toward the outside with coating clip.
(Avoid to touch the cable to electrical parts)

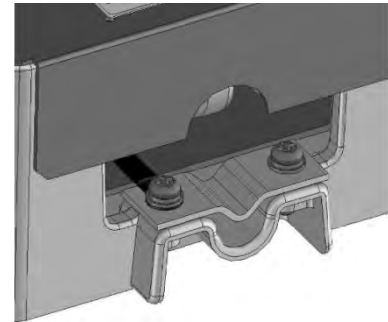
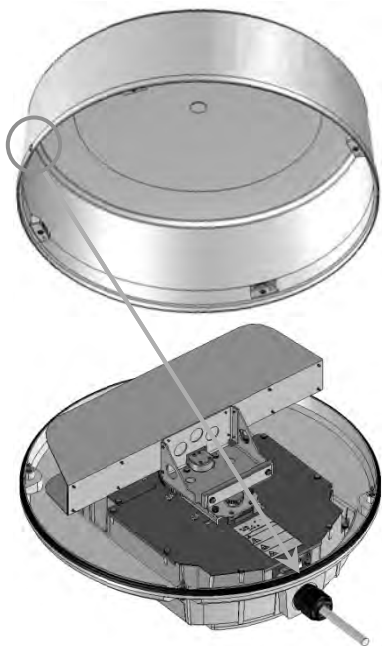

Fig. 1-4-1-4

■ **Close radome**

Attach the radome. Set the triangle mark in the center of the cable inlet.

In the following order, on the diagonal, tighten gradually in order to press uniformly packing.



Like this

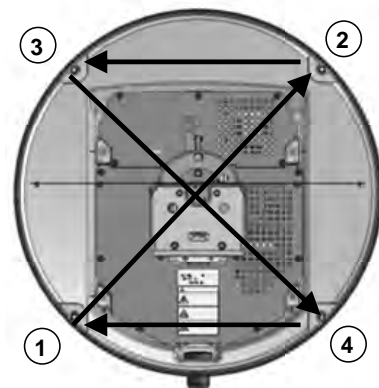

Fig. 1-4-1-5

1.4.2 NKE-2044 SCANNER (2 FEET)

Set the cable inlet side to stern.

(Any direction is possible to install and possible to initial setup, but it is better selection to select the cable length must be minimize along the mast.)



Fig. 1-4-2-1

■ Open radome

Loosen the screws by using box spanner tool, then you can lift up the radome.

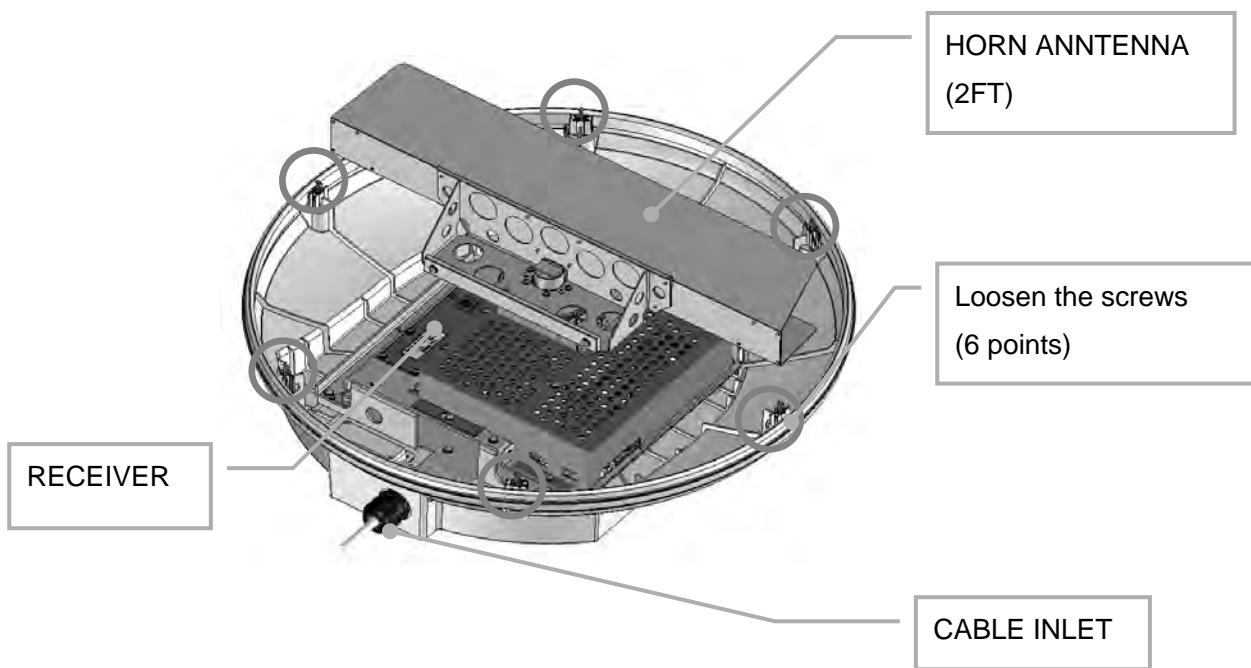
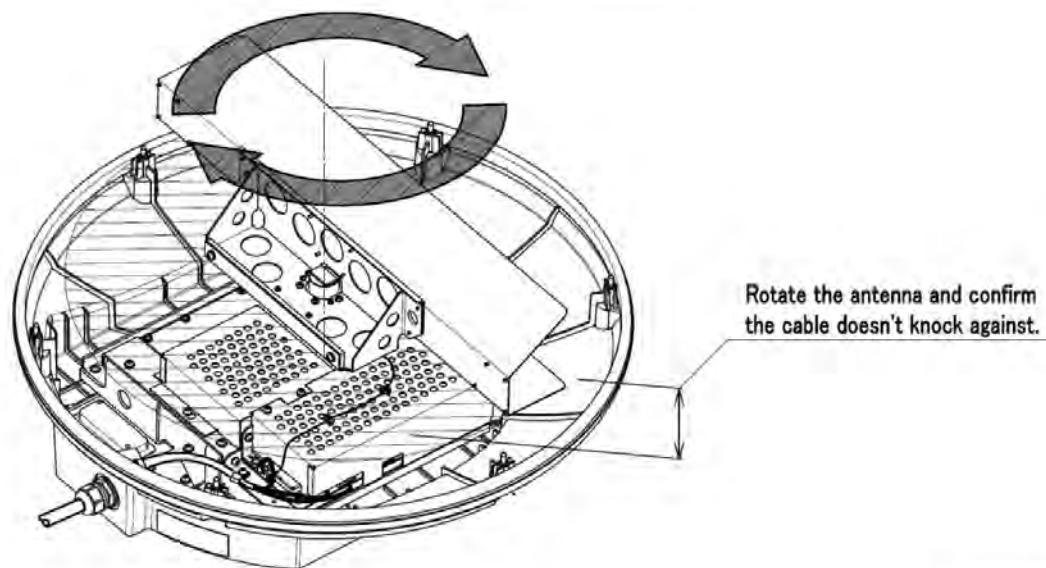
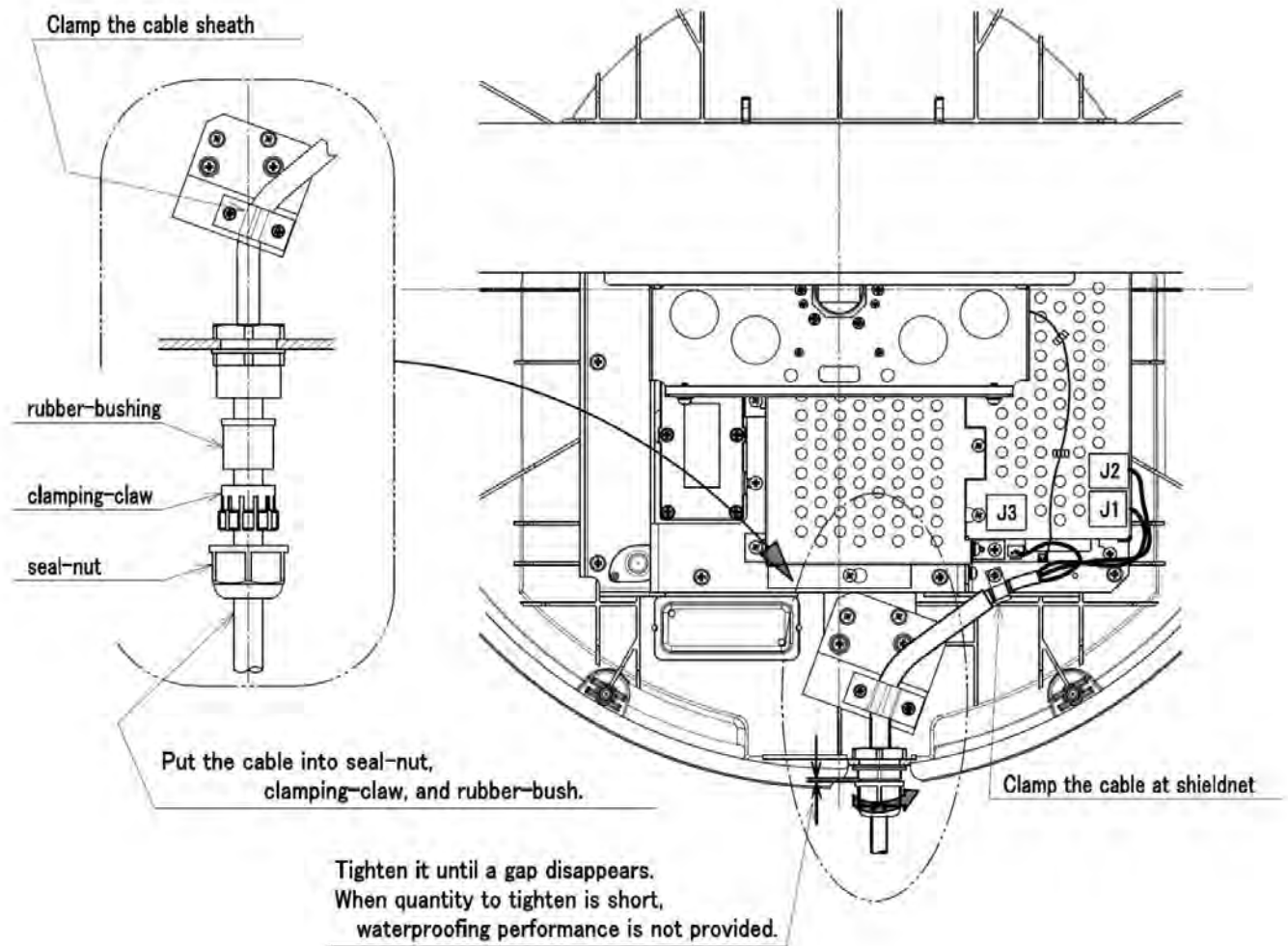

Fig. 1-4-2-2

Instruction for Equipment



MTZ304691-1/2-②

Fig. 1-4-2-3

⚠ CAUTION



When mounting the scanner unit, please check the maximum length of the holding bolts. If the bolts are too long, it gives severe damage to inside of the scanner. When mounting the scanner unit, please use the attached bolts.

The mounting base thickness must not exceed 15mm (0.6inch).

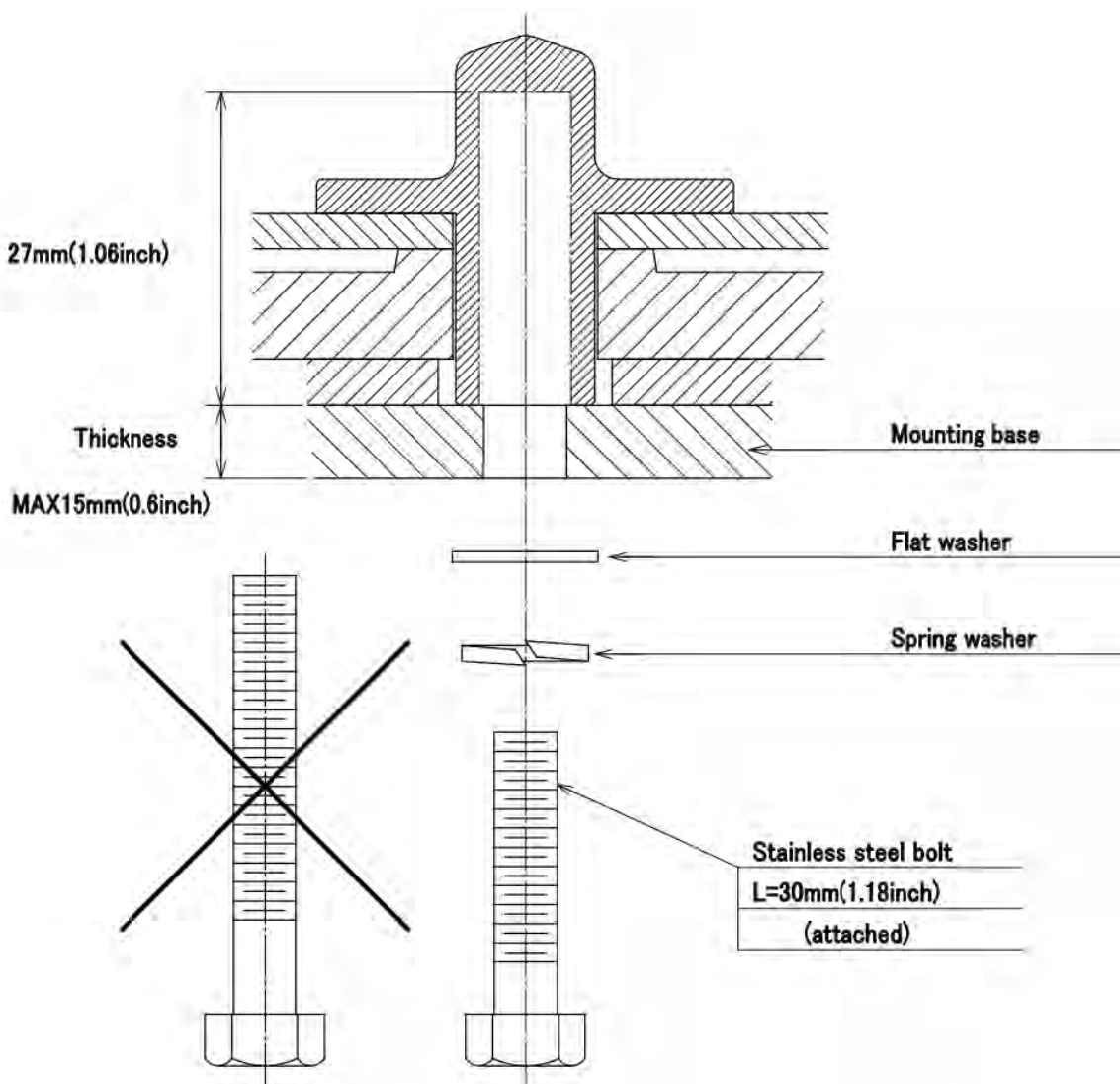

※ FIX THE BOLTS BY USING A STANDARD WRENCH (LENGTH 135mm TORQUE 2058[N·cm])

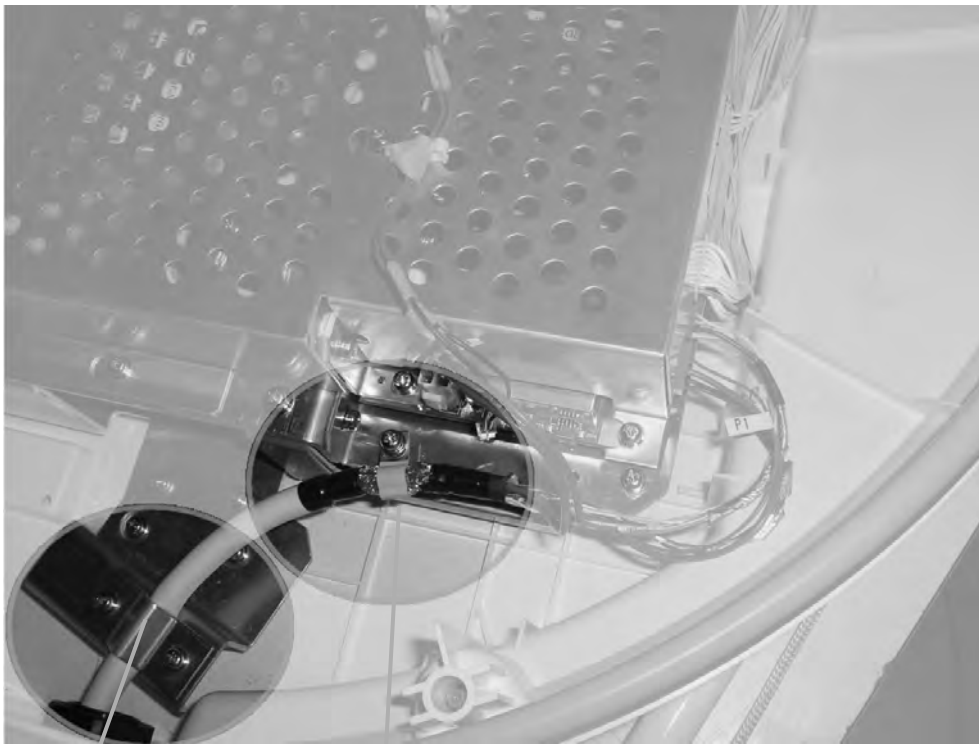

Fig. 1-4-2-4

Clamp the cable

Connect cable mesh wire as Ground.

■ **Close radome**

Attach the radome. Set to fit the triangle mark of the upper and lower radome.

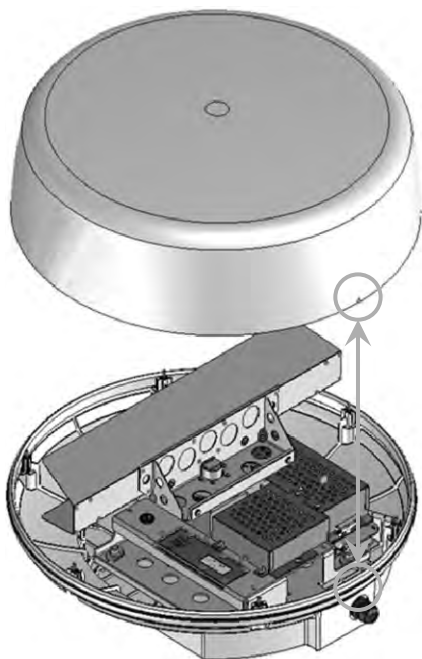

Like this



In the following order, on the diagonal, tighten gradually in order to press uniformly packing.

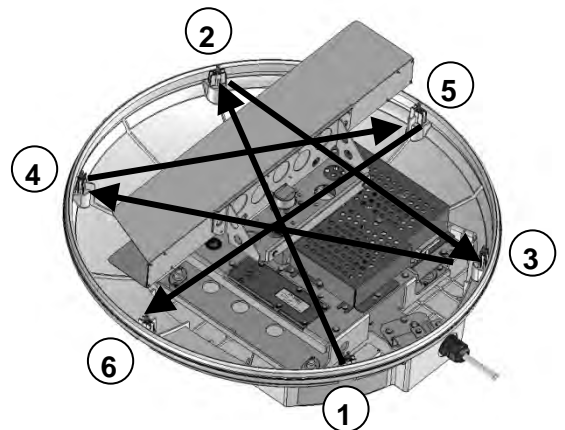

Fig. 1-4-2-5

Chapter 2 START THE BASIC OPERATION

If the basic adjustment is made by the serviceman beforehand, please run it as it is.

(In the case of no adjustment is done by the serviceman beforehand, you had better grasped the operation of this radar through referring to Chapter 5, then please perform the initial settings that are listed in Chapter 7.)

The high definition 7-inch wide display has a touch panel and can be operated by tracing a screen by means of a finger or touch pen. If you want to know what we mean when we mention tap, flick and swipe when you're using a touch screen, take a look at this table.

The operation with touch panel:

TAP:	Push an item once.
Swipe:	Sliding the finger while it is touching the screen.
Flick:	Flick is just like a swipe, only faster.
Long tap:	Pushing a item and keeping more than 3 seconds.

The operation of a Rotary knob:

Click:	Push in a Rotary knob once. Rotating and choosing the state of a screen, then click and fix.
--------	---

By using a touch sensor, it is possible to use the all functions of the radar.

On the other hand, by using the rotary knob, it is possible to control the radar in the same way as the touch sensor.

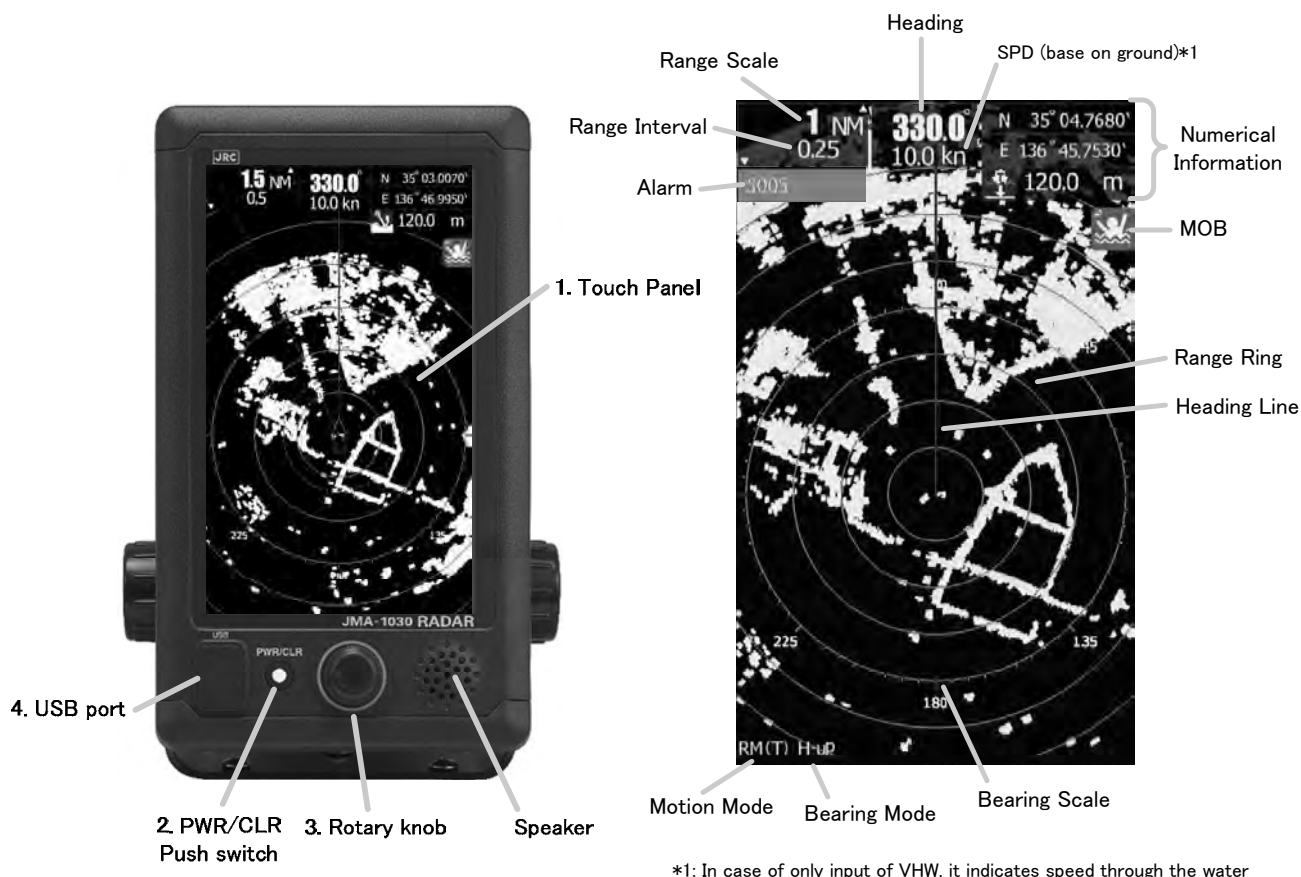

By using a combination of rotary knob and touch sensor, further comfortable radar operation is possible.

2.1 PANEL AND SCREEN DISPLAY LAYOUT



No.	Name	Description
1	Touch Panel	Tap : Push an item once Long tap : Push for a long time (about 3 seconds) Double tap : Carry out a tap twice quickly Flick : Operation to slide the finger quickly Swipe : Operation of sliding the finger on the screen
2	PWR/CLR Push Switch	Push : Turns on the equipment (when the power is turned off). Clear function (when the power is turned on) Long Push: Turns off the equipment (when the power is turned on)
3	Rotary Knob	Turn : Select the menu Push : Selection decision
4	USB port	Saves files. Updates the software.

2.2 POWER ON/OFF

⚠ CAUTION	
	A malfunction may occur if the power in the ship is instantaneously interrupted during operation of the radar. In the case, the power should be turned on again.
	When the display unit is turned off by the power drop, power supply to the scanner unit also stops. Make sure that the supply voltage to the display unit is stable, the power should be turned on again.

Note:

- Wait for about 2 seconds before turn on the power again.
- Immediately after the radar is installed, at start of the system after it has not been used for a long time, or after the magnetron is replaced, preheat the equipment in the standby state for 20 to 30 minutes before setting it into the transmit state.
- If the preheating time is short, the magnetron causes sparks, resulting in its unstable oscillation. Start transmission on a short-pulse range and change the range to the longer pulse ranges in turn. If the transmission is unstable in the meantime, immediately place the system back into the standby state and maintain it in the standby state for 5 to 10 minutes before restarting the operation. Repeat these steps until the operation is stabilized.

■ **Power on**

(90 seconds preheat time is required for cold start, because of the Magnetron heater.)
After 90 seconds, anytime transmitting is possible.



Reference:

The radar cannot start transmission if you press the TX/STBY icon while the preheating time is displayed.

■ Starting transmission

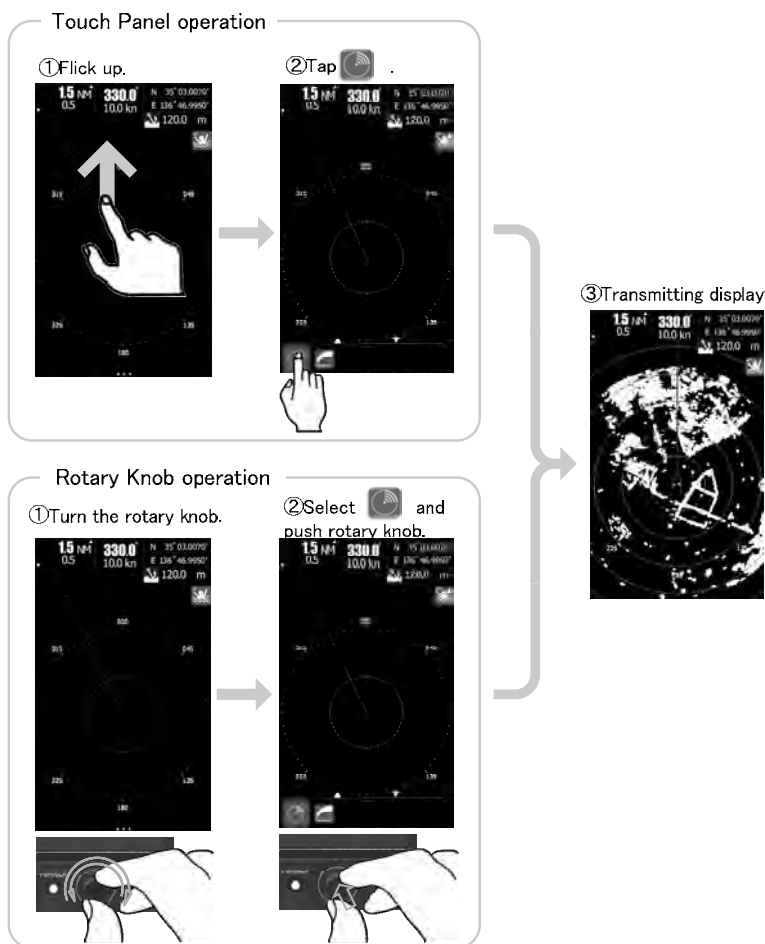

■ Stopping transmission

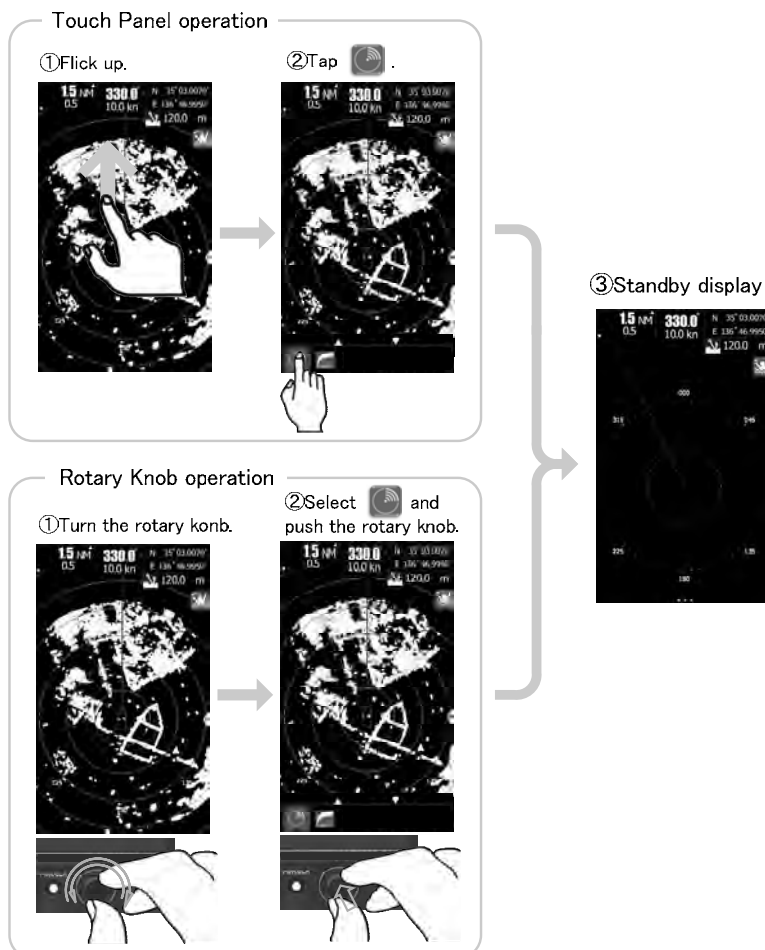

■ Power off



Press the PWR/CLR key 3 seconds or more.

2.3 SCREEN LAYOUT

2.3.1 STANDBY SCREEN

■ Startup screen (Startup screen can be selected from three choices below.)

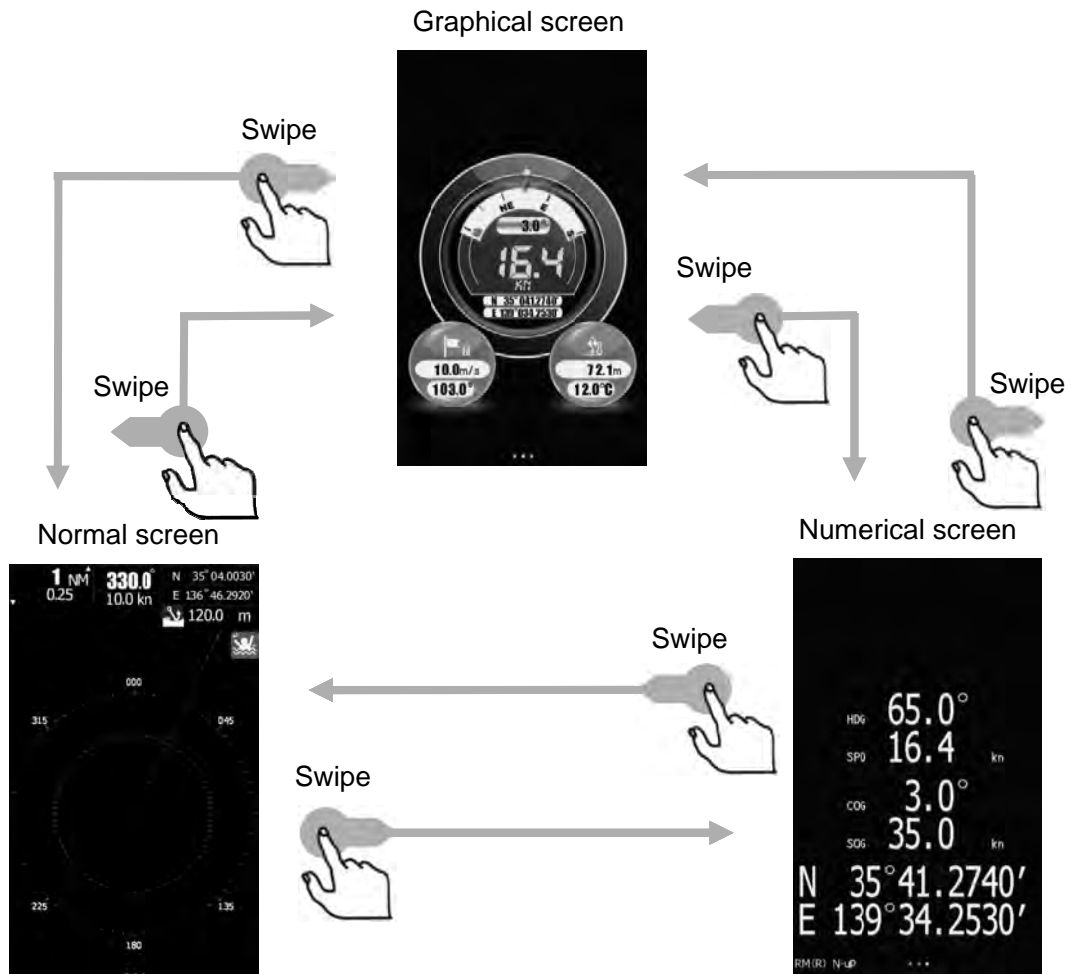

- Tap on the screen to select graphical display screen.

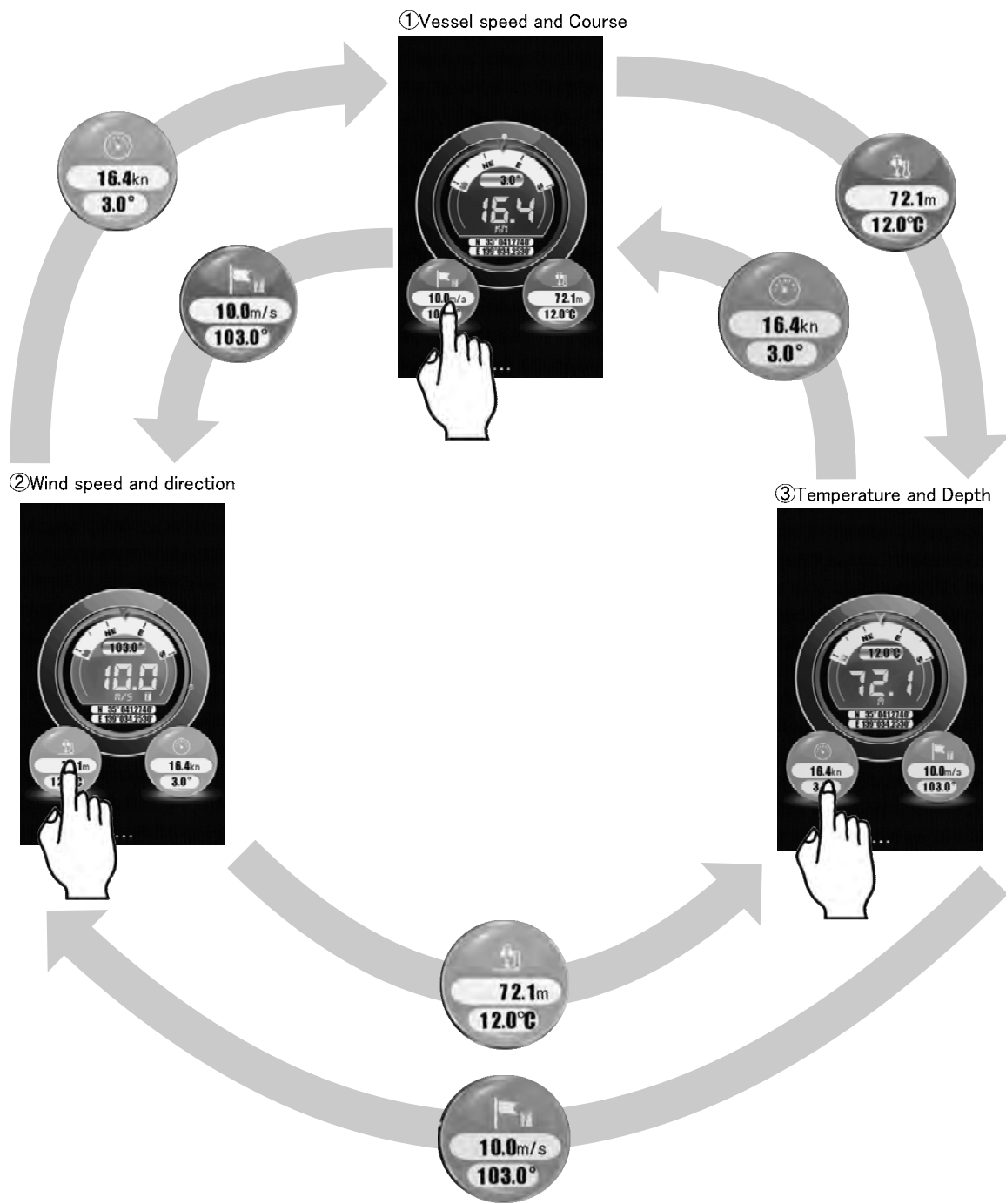

■ Various STBY screens and Icon menu

Normal screen

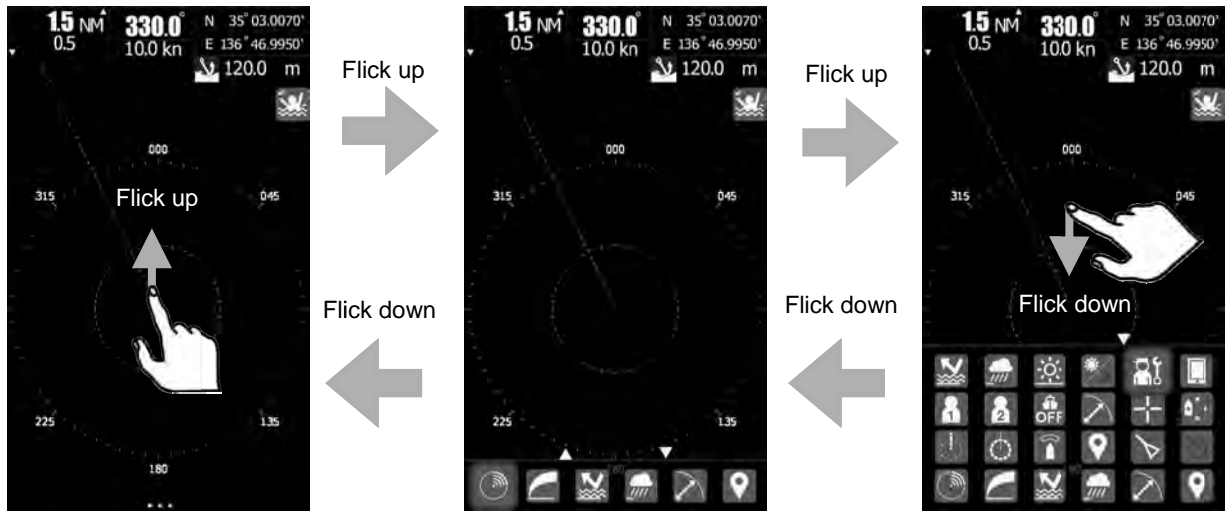

Graphical screen

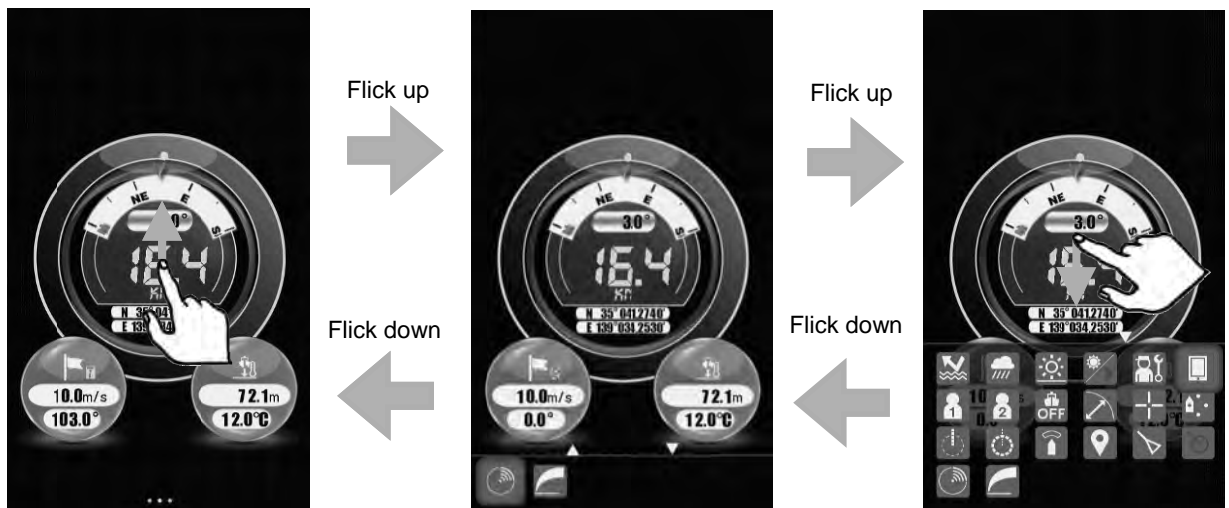

Numerical screen

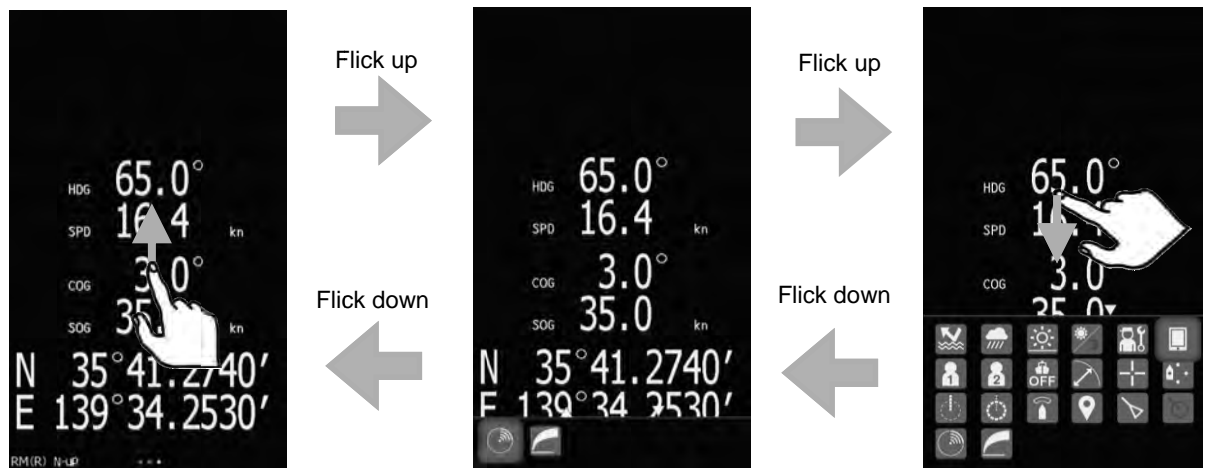

2.3.2 TRANSMISSION SCREEN

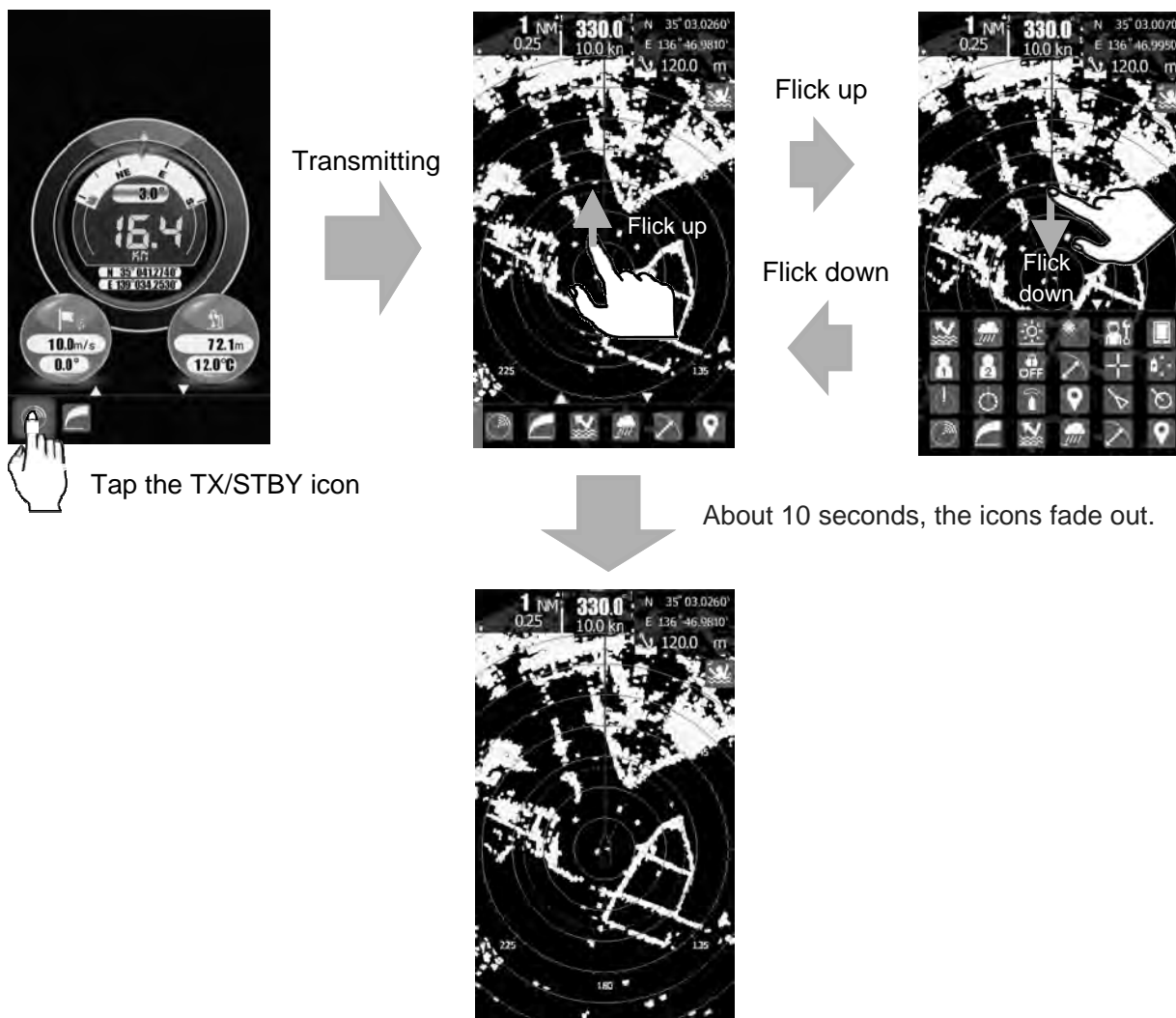

Push the rotary knob or flick the screen, then the resident icons will be displayed

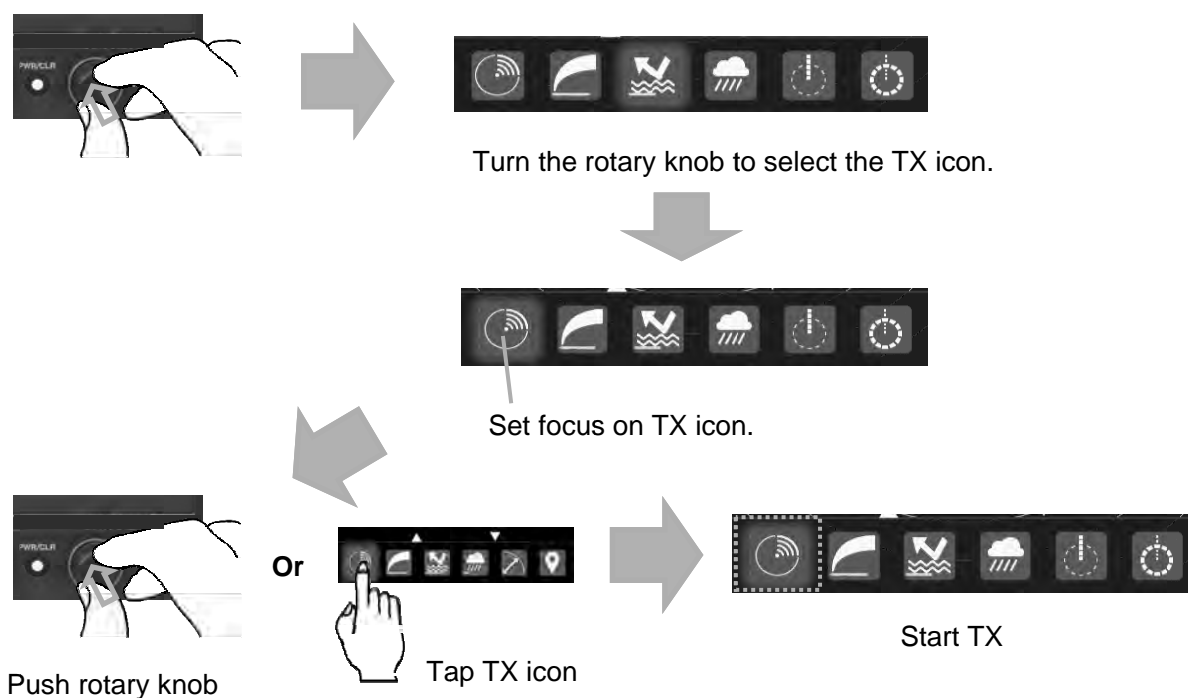

2.3.3 DISPLAY THE FUNCTION ICONS



Push the rotary knob to display the icons.

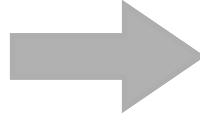

No operation about 10 seconds, the icons fade out.

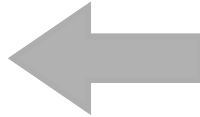

Turn rotary knob



Push rotary knob

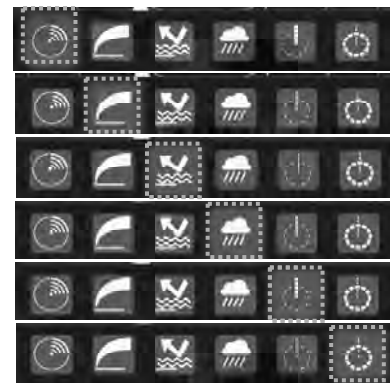

- Turn the rotary knob to select a function icon.
- Selected icon is focused.
- Push the rotary knob to execute function.
- Adjust the level by the rotary knob.
- Push the rotary knob to fix the setting.
(The same adjustment can be realized by a touch operation.)

Tap the TX/STBY icon, or push the rotary knob when the TX/STBY icon is focused.

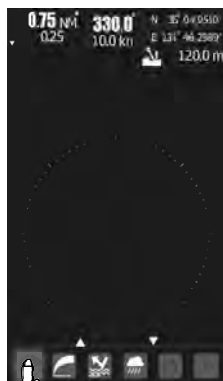

TX



STBY



Radar echo



Tap icon or push rotary knob



Tap icon or push rotary knob



Tap the GAIN icon, or push the rotary knob when the GAIN icon is focused.



The case of STBY



Adjustment Bar is shown.

The case of TX



Adjustment Bar is shown.

Tap "MANUAL" of Gain setting mode



Tap "Auto" of Gain setting mode



Gain is set automatically.

Monitor the green bar while turning the rotary knob.



Flick the green bar



Tap "+" or "-"



You should be adjust the gain level while monitoring the radar echo in TX mode.

Tap return icon



Push rotary knob



Push the rotary knob or tap the return icon to fix the setting.

Tap the SEA icon, or push the rotary knob when the SEA icon is focused.



Adjustment Bar is shown.

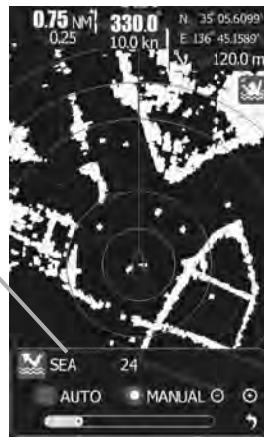

Please use normally the MANUAL. AUTO is suitable for bad weather that the adjustment is difficult at MANUAL.

It cannot be set at the same time as the RAIN AUTO.

Tap "MANUAL" of SEA setting mode



Tap "Auto" of SEA setting mode



SEA is set automatically.

In AUTO, the slide bar is enabled. It is a semi-automatic with adjustable AUTO.

Monitor the green bar while turning the rotary knob.



Flick the green bar



Tap "+" or "-"



You should be adjust the sea level while monitoring the radar echo in TX mode.

Tap return icon

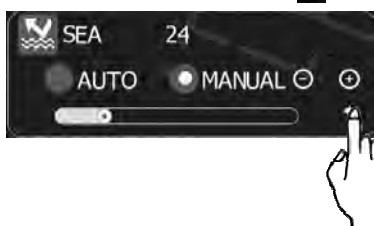

Push rotary knob



Push the rotary knob or tap the return icon to fix the setting.

Tap the RAIN icon, or push the rotary knob when the RAIN icon is focused.



Adjustment Bar is shown.

Please use normally the MANUAL. AUTO is suitable for bad weather that the adjustment is difficult at MANUAL.

It cannot be set at the same time as the SEA AUTO.

Tap "MANUAL" of RAIN setting mode

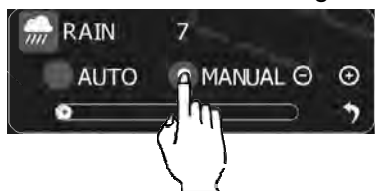

Tap "Auto" of RAIN setting mode

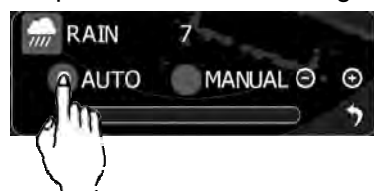

RAIN is set automatically.

In AUTO, the slide bar is enabled. It is a semi-automatic with adjustable AUTO.

Monitor the green bar while turning the rotary knob.

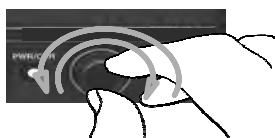

Flick the green bar



Tap "+" or "-"



You should be adjust the rain/snow clutter suppression level while monitoring the radar echo in TX mode.

Tap return icon

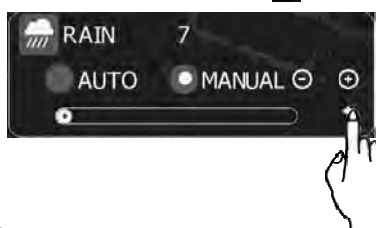

Push rotary knob



Push the rotary knob or tap the return icon to fix the setting.

2.4 BRIEF EXPLANATION OF ICON'S FUNCTION

Brief explanation of each icon.



GAIN (gain control) adjustment:
Set up the sensitivity of Radar echo.



SEA (sea-clutter rejection) adjustment:
Control the sea clutter level near the ship.
Long distant echo gain is remaining as it is, and gain is lowered as to short distance.
Adjust the target ship is clearly observe and reject the sea clutter on screen as much as possible.



RAIN (rain-and-snow-clutter rejection) adjustment:
This type radar uses (X) band microwave (wavelength: 3cm).
This microwave can detectable more far range in fine weather, but in rain or snow weather, the detectable range decrease remarkably.
The control is adjusted for separate the target and rain or snow as long as possible.



BRILL (brightness) adjustment: Set up the brightness of a screen.
It sets up brightly daytime and sets up not dazzle at night



MOB (Man Over board): When the crew fall into over the boat by accident.
Carry out a tap MOB icon immediately.
The radar memorizes the place latitude and longitude information, and continues displaying the (MOB)place on a screen.
When going to rescue, navigator can take course to the(MOB)point on screen.
(Important: GPS signal must be connected in this function.)



TT DATA (target tracking)
Data which is tracking automatically is displayed.
Data is display the direction, the distance, the speed.
This function must be required the heading signal and log signal.
Measures reading of a direction can select from north(N-UP) and measure from self-ship (H-UP). **(Heading and GPS signal is necessary.)**



The speed display can select the relative speed mode or absolute speed mode.
AIS DATA (when received the AIS signal, the data of MMSI of the vessel which has transmitted, latitude, longitude, a direction of movement, speed, rate of turn, etc. is displayed.)
(AIS receiver signal, heading and GPS signal is necessary.)



EBL (electronic bearing line)
Measure the target direction by using cursor line.



VRM (variable range marker)
Measure the target distance by using circle line.



Off-center (Normally own position is the center of screen, but it is possible to move own position from fixed center of screen).

Tap the icon will shift the own position. Shifting point are fixed 5 positions only.



TX (transmission), ST-BY (standby)

Whenever it carries out a tap, transmission and ST-BY are changed.



RANGE (range scale)

The range scale to observe is changed. The maximum range is limited by the scanner type which is connected.

NKE-1066 scanner

0.0625NM 0.125NM 0.25NM 0.5NM .075NM 1.5NM 3NM 6NM 12NM 24NM.

(Also 1NM, 2NM, 4NM, 8NM, 16NM are possible by system menu setting.)

NKE-2044 scanner

0.0625NM 0.125NM 0.25NM 0.5NM .075NM 1.5NM 3NM 6NM 12NM 24NM 48NM.

(Also 1NM, 2NM, 4NM, 8NM, 16NM, 32NM are possible by system menu setting.)



Switch Day / Night Mode

Two combinations of the display color and brilliance according to the ambient lighting conditions are provided.

The display color setting is easily changed.



User Option icon

Users can freely make setting with option keys  and .



Assign a heavily-used function to a user option icon, then you can start it by only one touch.



Various system setups

Tap the setting icon, the initial setting menu will be displayed.

Start the initial setting menu by entering the code '0'.

Choose a item and set up individually.

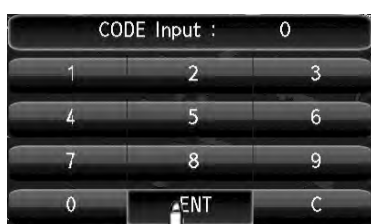

Main menu

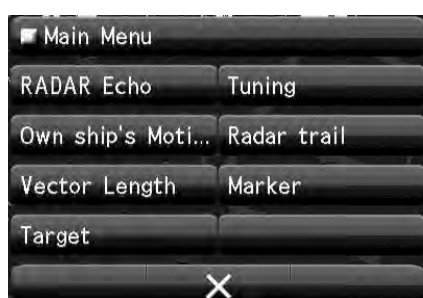



GUARD ZONE setup

Set up the watching area around own-ship.

If a target goes into the set-up area, generate the alarm sound or signal..

On the other hand, if a target goes out the set-up area, generate the alarm sound or signal, too. One of both is possible to select.



Cursor: A tap is carried out, start, drag and tap off on the target.

The position of this cursor is indicated.

Various kinds of pointing actions uses this cursor..

Tracking of target, AIS data display, setting of guard zone, etc.



MARK: Use when plot a mark on the screen.

Moreover, also when deleting an unnecessary mark, it uses.

(Heading and GPS signal is necessary.)

When you want to set the optimum state by situation settings complex radar signal processing function, try the function that can be easily set by calling a content set in advance settings, the following icon. In addition, it is also possible to change the radar echo of your choice by changing the adjustment value for each function after setting.



Mode OFF: Mode function easily sets most appropriate settings in each condition.

Mode OFF sets no specified settings.



Mode Standard: Mode Standard is suitable to monitor relatively short range.



Mode Coast: Mode Coast is suitable to monitor relatively short range, for example, bays and coasts where many boats and ships are running.



Mode Float: Mode Float is suitable to detect small targets such as fishnets or round netters hidden by sea clutter returns.



Mode River: Mode River is suitable for using river. This mode reduce sea clutter returns.

2.5 SETTING THE RESIDENT ICONS

All of the icons are displayed.

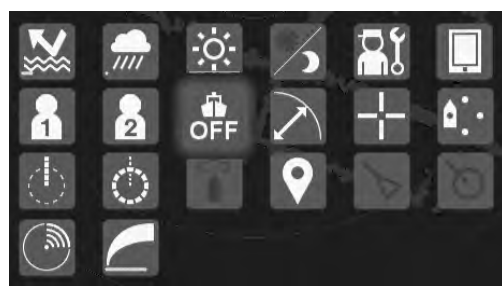

Specified icons can be copied to the favorite icon area.

Fixed icons (TX/STBY, Gain)

You can line up your favorite function icons in this area. (4 or less)

How to copy icon

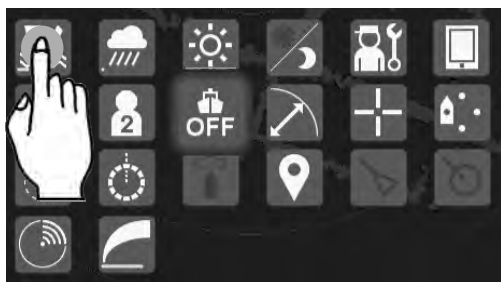

Tap and hold the icon



Tapped icon is copied to the favorite icon area

How to remove icon



Tap and hold the icon listed in the favorite icon area.



Tapped icon is removed from the favorite icon area. Then the remaining icons are shifted to the left.

Chapter 3 ADJUST THE RADAR ECHO

3.1 CHANGE RANGE



This picture is selected 1.5NM range.

Outer dashed line shows the range of selected range.

Range is easily changed by tap increase / decrease icon as shown in the figure below.



Adjusted by the range icon.



Range scale list

Range (NM)	NKE-1066 (JMA-1032)	NKE-2044 (JMA-1034)
0.0625NM	<input type="radio"/>	<input type="radio"/>
0.125NM	<input type="radio"/>	<input type="radio"/>
0.25NM	<input type="radio"/>	<input type="radio"/>
0.5NM	<input type="radio"/>	<input type="radio"/>
0.75NM	<input type="radio"/>	<input type="radio"/>
1NM	<input type="radio"/>	<input type="radio"/>
1.5NM	<input type="radio"/>	<input type="radio"/>
2NM	<input type="radio"/>	<input type="radio"/>
3NM	<input type="radio"/>	<input type="radio"/>
4NM	<input type="radio"/>	<input type="radio"/>
6NM	<input type="radio"/>	<input type="radio"/>
8NM	<input type="radio"/>	<input type="radio"/>
12NM	<input type="radio"/>	<input type="radio"/>
16NM	<input type="radio"/>	<input type="radio"/>
24NM	<input type="radio"/>	<input type="radio"/>
32NM	<input type="checkbox"/>	<input type="radio"/>
48NM	<input type="checkbox"/>	<input type="radio"/>

3.2 SENSITIVITY ADJUSTMENT



The gain level is displayed in the bottom portion of the icon. It is possible to judge the gain level by the length of a green bar roughly.

It is necessary to set an appropriate gain level in order to use the radar exactly. Failure to do so, it is possible to obtain an accurate radar echo.



How to change the Gain level: Please refer to the gain adjustment method described in Chapter 2.3.3.

Examples of the radar echo sensitivity as follows.

Radar echo sensitivity
Low



Radar echo sensitivity
Middle



Radar echo sensitivity
High



It is important to be note that if you adjust the gain level to maximum, the noise might be also displayed on the screen at the same time.

GAIN set Exceed



In the case of a fine weather, gain level is set close to the maximum values usually. In the case of a bad weather, such as heavy rain or snow or rough seas, it is necessary to adjust not only the gain level, but also the sea clutter suppression function and rain/snow clutter suppression function. You need to choose an appropriate level, respectively.

CAUTION



If sensitivity is set too high, unnecessary signals such as noises in the receiver and false echoes increase to lower target visibility. At the same time, if sensitivity is set too low, detection of targets such as ships and dangerous objects may be hindered. Therefore, sensitivity must always be set to an optimal level.

3.3 SEA CLUTTER SUPPRESSION



It is necessary to adjust the sea clutter suppression level in order to use the radar exactly. Failure to do so, it is possible to obtain an accurate radar echo.

The sea clutter suppression level is displayed in the bottom portion of the icon. It is possible to judge the suppression level by the length of a green bar roughly.



How to change the SEA clutter suppression level: Please refer to the sea clutter suppression adjustment method described in Chapter 2.3.3.

Sea Clutter suppression level
LOW

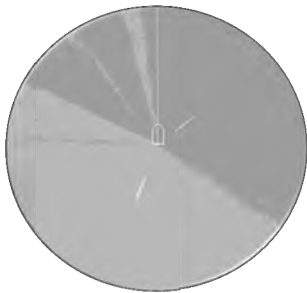

Sea Clutter suppression level
Suitable level



CAUTION



When using the sea clutter suppression function, never set the suppression level too high canceling out all image noises from the sea surface at close range. Detection of not only echoes from waves but also targets such as other ships or dangerous objects will become inhibited. When using the sea clutter suppression function, make sure to choose the most appropriate image noise suppression level.

3.4 RAIN/SNOW CLUTTER SUPPRESSION



It is necessary to adjust the rain/snow clutter suppression level in order to use the radar exactly. Failure to do so, it is impossible to obtain an accurate radar echo.

The rain/snow clutter suppression level is displayed in the bottom portion of the icon. It is possible to judge the suppression level by the length of a green bar roughly.



How to change the RAIN clutter suppression level: Please refer to the rain clutter suppression adjustment method described in Chapter 2.3.3.

Rain clutter suppression level suitable
(fine weather)



Rain clutter suppression level excessive
(some targets become small)

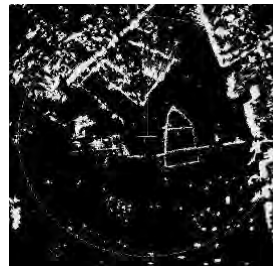

The [RAIN] control can make targets hidden by rain/snow clutter returns appear on the radar display. Be careful that excessive suppression may cause small targets to be overlooked.

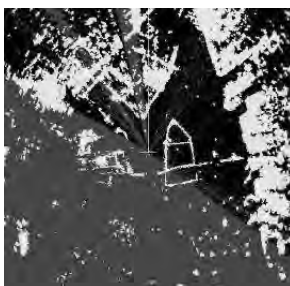

CAUTION



When using the rain/snow clutter suppression function, never set the suppression level too high canceling out all image noises from the rain or snow at close range. Detection of not only echoes from the rain or snow but also targets such as other ships or dangerous objects will become inhibited. When using the rain/snow clutter suppression function, make sure to choose the most appropriate image noise suppression level.

3.5 SCREEN BRILLIANCE (another operation)



The brightness adjustment menu appear by tapping brightness adjustment icon, but it will appear when you double-tap on the screen too. In addition, by turning while pressing the rotary knob also appeared.

The brilliance level is displayed in the bottom portion of the icon. It is possible to judge the brilliance level by the length of the green bar roughly.

Double tap

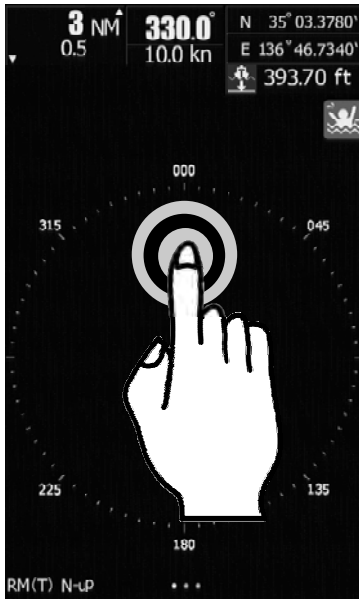

Brilliance Menu appears

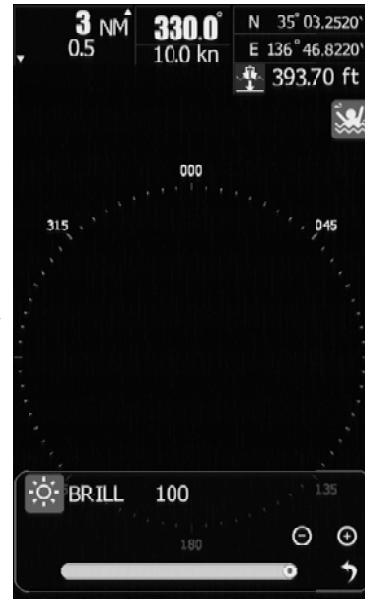

Turn while pressing the rotary knob

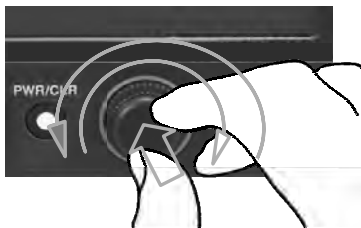

Screen brightness also can be adjusted by using the rotary knob at any time. Even if you cannot touch the function icon to adjust the brightness in the case of the screen is pitch-dark. Turning while pressing the rotary knob, then the screen is released from the dark state.

* * * * **FOR REFERENCE** * * * *

In order to obtain an accurate radar echo, sea clutter suppression adjustment and gain adjustment are essential.

RAIN: Normally is set to "0". But in the case of rain or snow, you need use the rain clutter suppression function to remove the noise appearing on the screen.

GAIN: Adjust the GAIN to increase receiving sensitivity, then the radar observation range can be extended. If the sensitivity is set too high, the receiver noise is increase, and the contrast between the targets and the background video is reduced. As a result, the targets become obscure on the radar display. To observe densely crowded targets or short-range targets, adjust the GAIN to reduce the sensitivity so that the targets are easy to observe. However, be careful not to overlook important small targets.

SEA: SEA clutter suppression function can suppress the near range clutter noise. If the suitable adjustment is done, you can observe a clear target from short range to long range.

When the automatic mode is selected for the rain/snow clutter suppression function, the sea clutter suppression function is switched to the manual mode. The sea clutter suppression function (AUTO) and the rain/snow suppression function (AUTO) cannot be selected at the same time. In addition, Please adjust the video in function (MANUAL) usually. Please attempt the function (AUTO) when the video adjustment of short-range cannot adjust by the bad weather.

< ACTUAL OPERATION >

Set RAIN clutter suppression level to 0.

- (1) Set RANGE to more than 6NM, and determine the target in the distance. The target location is far, and the targets as far possible can barely display is preferable. Set GAIN in order to observe the target clearly.
- (2) Change RANGE to 0.5NM, and set SEA clutter suppression level to observe the near target clearly. If you reduce the GAIN at this time, the target that was able to display at (1) will be not able to display, please note on the relation between the long range.
- (3) Since the rain/snow clutter suppression function also has the effect of suppressing sea clutter, the suppression efficiency improves when using with the [SEA] control. In general, RAIN clutter suppression level is set to "0". But if you encounter a bad weather, set RAIN clutter suppression level to achieve better observation state.

Chapter 4 VRM AND EBL FUNCTION

4.1 OPERATION OF VRM, EBL

- VRM: Flick on the screen, VRM ring can be moved to the specified target. Then distance to the target is displayed on the screen. Of course, the same operation can be realized by the rotary knob.
- Erase VRM: Double tap the VRM icon, or double push the rotary knob when the VRM icon is selected.
- EBL: Flick on the screen, EBL line can be rotated to the specified target. Then the target bearing is displayed on the screen. Of course, the same operation can be realized by the rotary knob.
- Erase EBL: Double tap the EBL icon, or double push the rotary knob when the EBL icon is selected.

4.2 EXAMPLE OF VRM FUNCTION

Example: VRM function



Range from own ship to the target is displayed.



Menu bar disappears after about 10 seconds.

How to change the VRM

Flick on the screen, then the VRM ring will move along with the fingertip.



Turn the rotary knob to control the movement of the VRM ring.

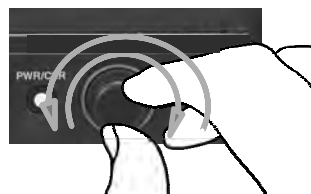

Or

4.3 EXAMPLE OF EBL FUNCTION

Example: EBL function.

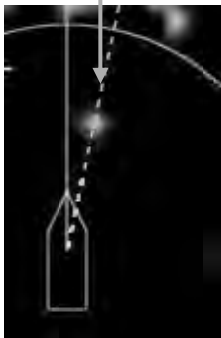

Target bearing is displayed.



Menu bar disappears after about 10 seconds.

How to change the EBL

Flick on the screen, then the EBL line will move along with the fingertip.



Turn the rotary knob to control the movement of the EBL line.

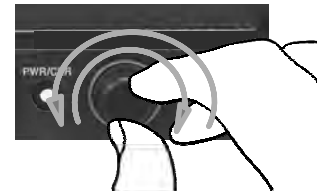

Or

* * * * **FOR REFERENCE** * * * *

ABOUT EBL/VRM FUNCTION

The target position and range information can be measured by EBL and VRM function.

Bearing measurement method:

- (1) The RELATIVE BEARING which is measured from own ship heading line.
- (2) The ABSOLUTE BEARING which is measured from the north line.

Certainly, ABSOLUTE BEARING is calculated by RELATIVE BEARING and GYRO BEARING.

So, to calculate the ABSOLUTE BEARING is necessary a signal from GYRO or GPS compasses.

In case of no external bearing signal, display only RELATIVE BEARING mode.

Target tracking function (TT) and display AIS symbol is necessary the GYRO or GPS compass signal.

When GYRO or GPS compass signal is received, normally azimuth is measured from the north (ABSOLUTE AZIMUTH).

This radar scanner has a microwave BEAM WIDTH is about 5.2 degrees (NKE-1066) or 4 degrees (NKE2044).

So every target echo has more than 5.2 degrees or 4 degrees width for bearing direction.

For above reason, in case of read out the target azimuth, you need set EBL line to the center of the target echo.

RANGE of target echo in any azimuth can be measured by the VRM function from own ship.

Target echo size is proportion to pulse length which transmitted from own ship.

In case of MEASURE SHORT RANGE ECHO using VRM, you need set ring to the echo's nearest point from own ship.

At that point, you can get the correct RANGE for any pulse length.

Chapter 5 VARIOUS FUNCTION ICONS

5.1 MOB FUNCTION (MAN OVERBOARD)

To use this function, ship's position information is required.



Due to the movement of the boat, there is a possibility that a person fall from boat. The JMA-1030 series radar provides a single-press Man Overboard (MOB) operation. Instantly, a dedicated symbol arises on the screen including a range detailed info such as position bearing, range and time till arriving at MOB. This emergency system enables immediate and accurate search and rescue efforts.

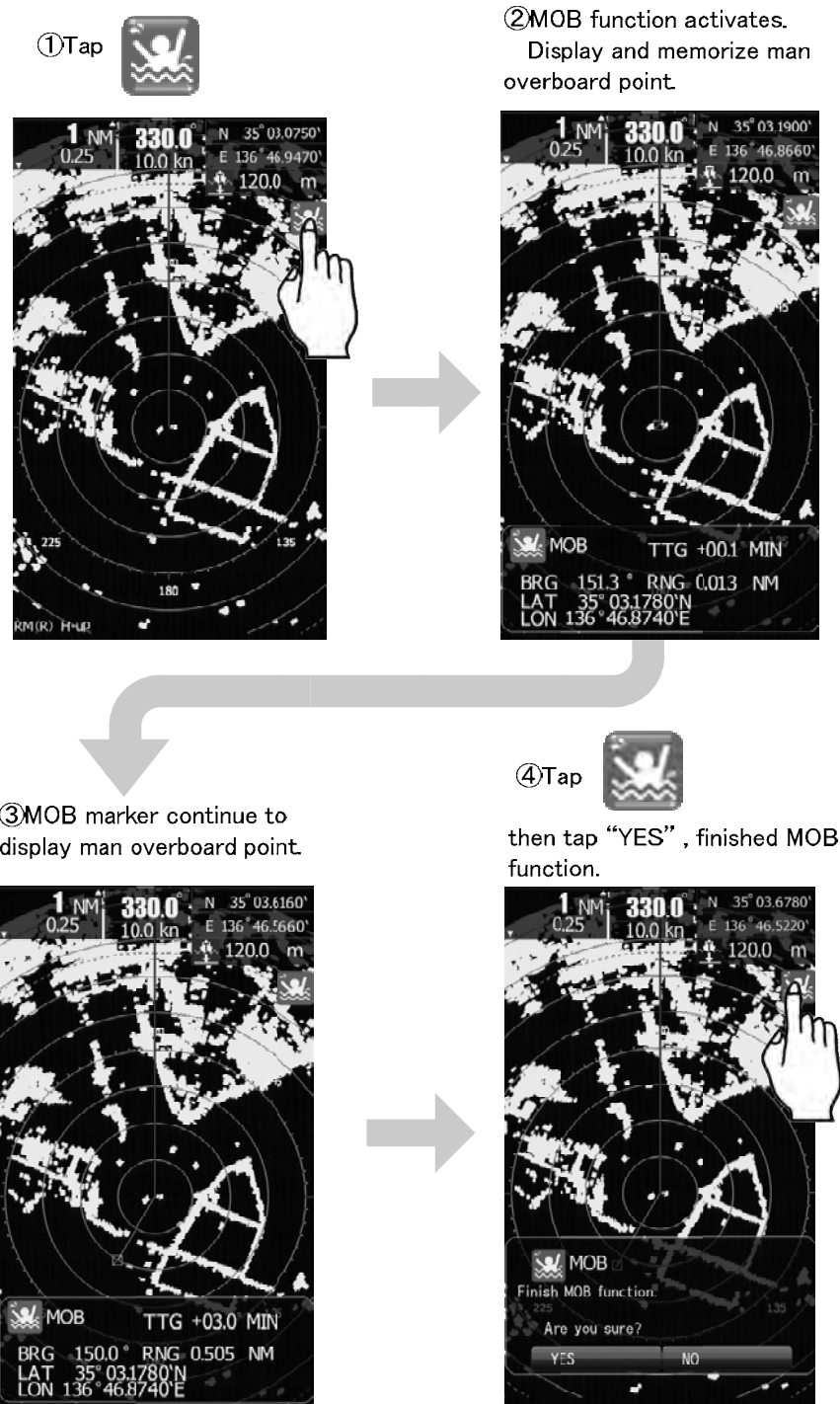

5.2 OFF-CENTER FUNCTION



It is possible to shift the center of own ship in order to observe a particular target in a wider range. Be to tap once on the icon, center of own ship will be shifted as the following figures.

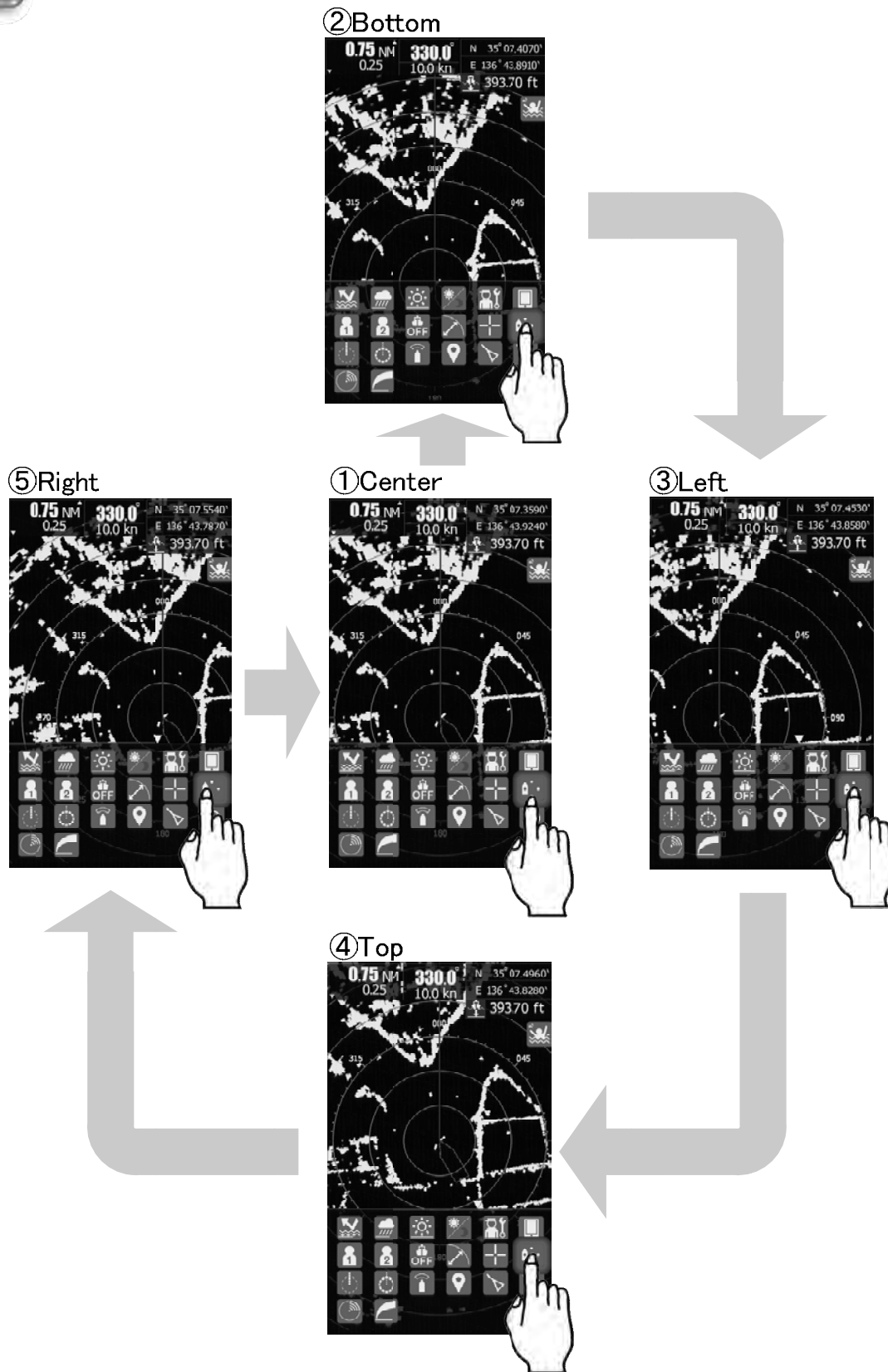

5.3 CURSOR FUNCTION



Using the cursor function can read out a selected target information. Tap the cursor icon. Tap anywhere on the screen, the cursor mark is displayed in place where it has been tapped. At the same time, the range and bearing information at that point are displayed in the lower side of the screen. If the GPS signal coming in, the latitude and longitude information of that point are also can be displayed.

Tap anywhere on the screen

“BEARING” BRG 20.0°
 “RANGE” RNG 0.3464NM
 “TTG” TTG +2.1MIN

In case of GPS signal coming in

“Latitude” LAT 35° 04.2292’N
 “Longitude” LON 136° 46.3008’E

Do not touch the screen for about 10 seconds, the information bar will be fade out.

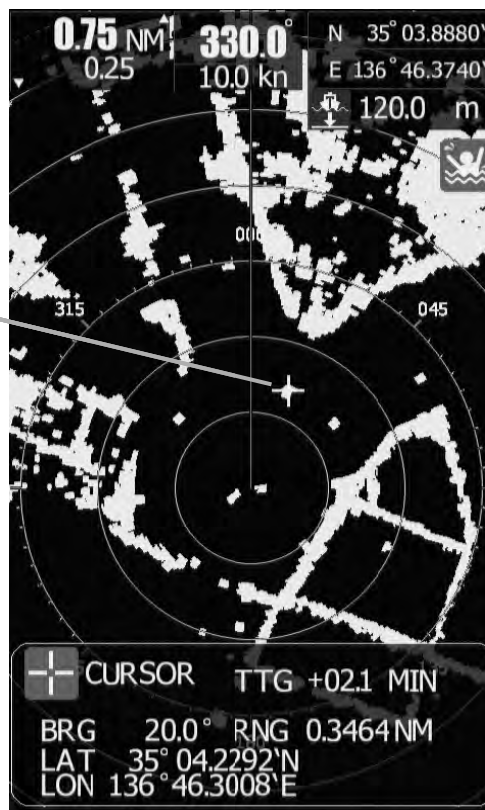

The cursor elimination method



The cursor icon is eliminable by carrying out a double tap.

5.4 GUARD ZONE FUNCTION

To use this function, ship's heading information is required.



Guard zone function used to detect an echo movement in the warning area. Guard zone can be set as IN-ALARM or OUT-ALARM or AUTO-TT.

IN-ALARM: When a target entered the set zone, the alarm sounds.

OUT-ALARM: When a target went out of the set zone, the alarm sounds.

AUTO-TT: Target tracking automatically.

VIEW: Show the zone that you set

OFF: Function OFF

These zones act as suppression zones, avoiding unnecessary overloading to the processor and clutter by disabling automatic acquisition and tracking outside them.

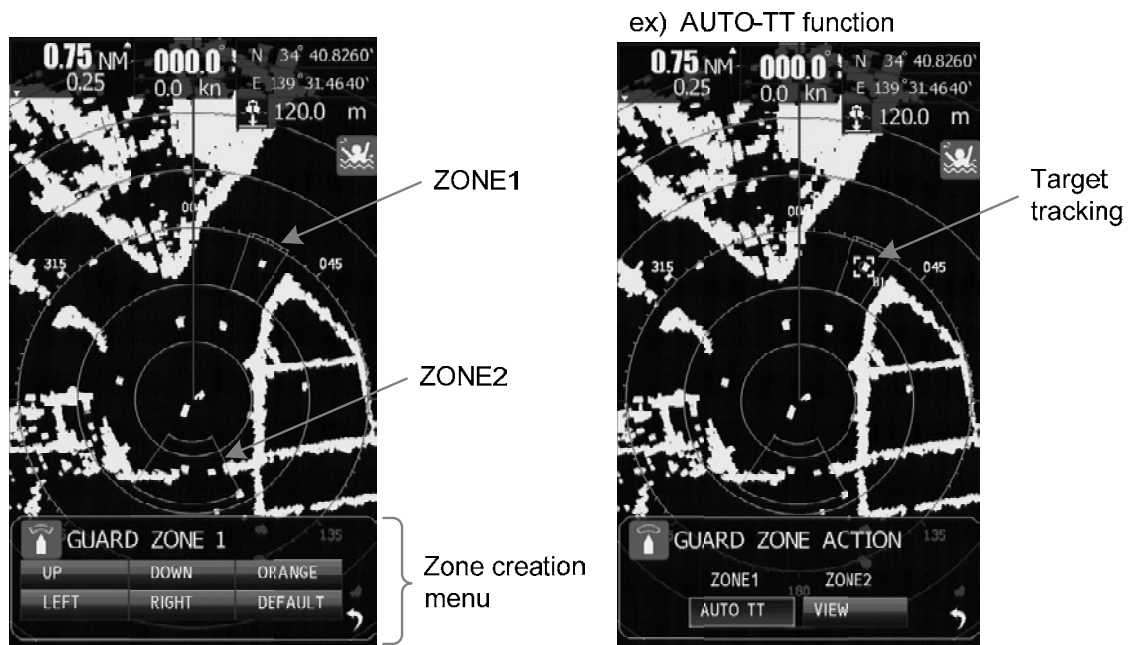

* * * * FOR REFERENCE * * * *

Guard zone is moving accord with own ship movement.

JMA-1030 series marine radar let you set a guard zone around your boat. You can specify distance and set an alarm.

If your boat detects a buoy, landmass or any other obstacle within your guard zone, the alarm sounds.

Guard zone function can help you monitor objects near to your boat and objects further away at the same time.

5.5 RADAR TRAILS

This “radar trails” function can be used to figure out how well you can navigate an obstacle and how well you can keep the bearing that have set for your boat. The echo trail is displayed on the radar display screen so you can easily assess visually what is going on.

5.5.1 SETUP THE TRAIL LENGTH

Other ship’s movement and speed can be monitored from the lengths and direction of their trails, serving for collision avoidance. In this section, choose from the Short, Middle, Long or Super long. The selected group of trails is displayed in the main menu.

Short: OFF/15sec/30sec/1min/2min/3min/4min/5min/6min/10min/15min/CONT

Middle: OFF/30sec/1min/2min/3min/4min/5min/6min/10min/15min/30min/CONT

Long: OFF/1min/2min/3min/4min/5min/6min/10min/15min/30min/1hour/CONT

Super Long: OFF/30min/1hour/2hour/3hour/4hour/5hour/6hour/10hour/12hour/24hour/CONT

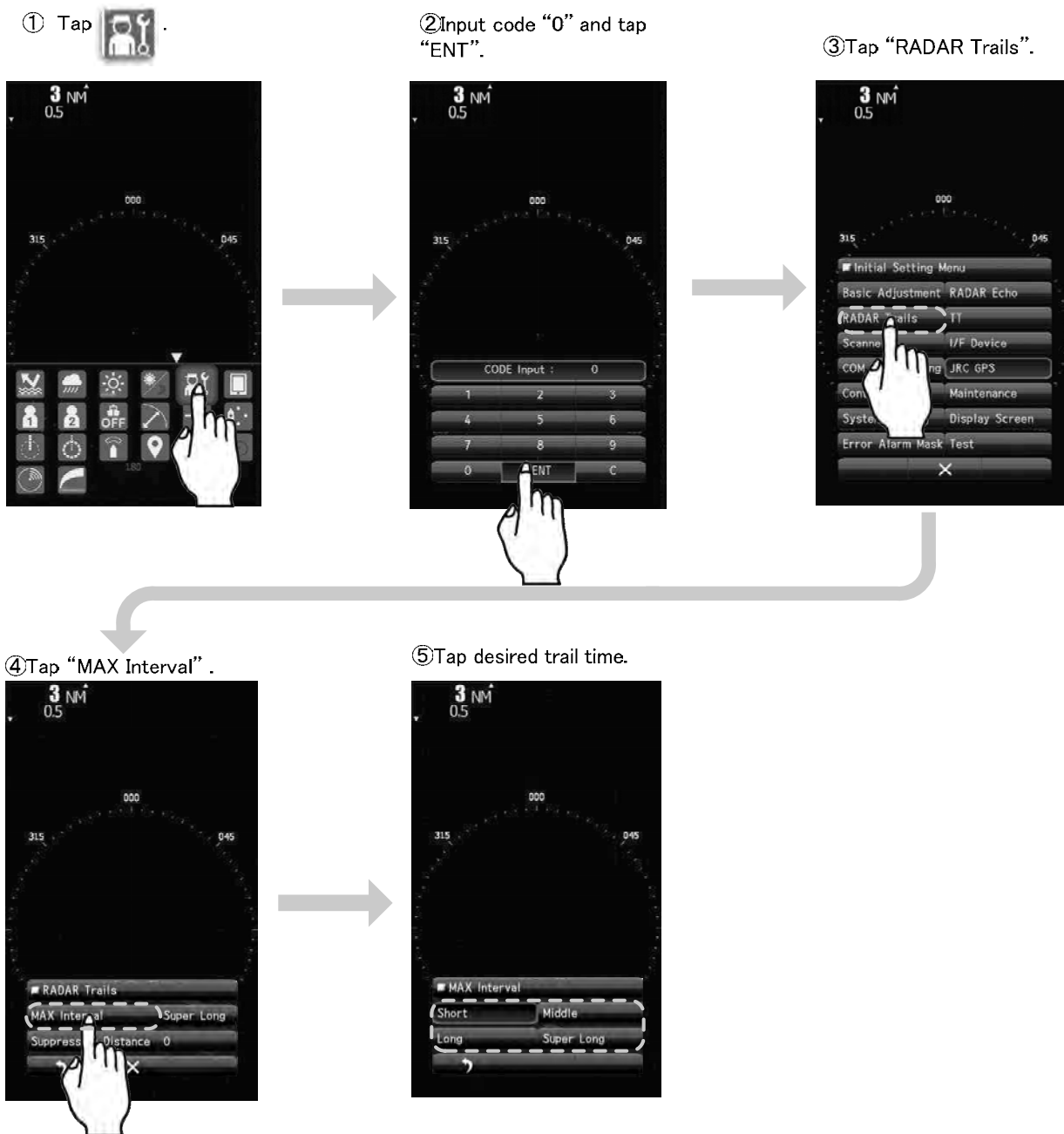

5.5.2 SETUP THE RADAR TRAILS REF LEVEL, etc

You can be selected in the range of trail length set by 5.5.1.

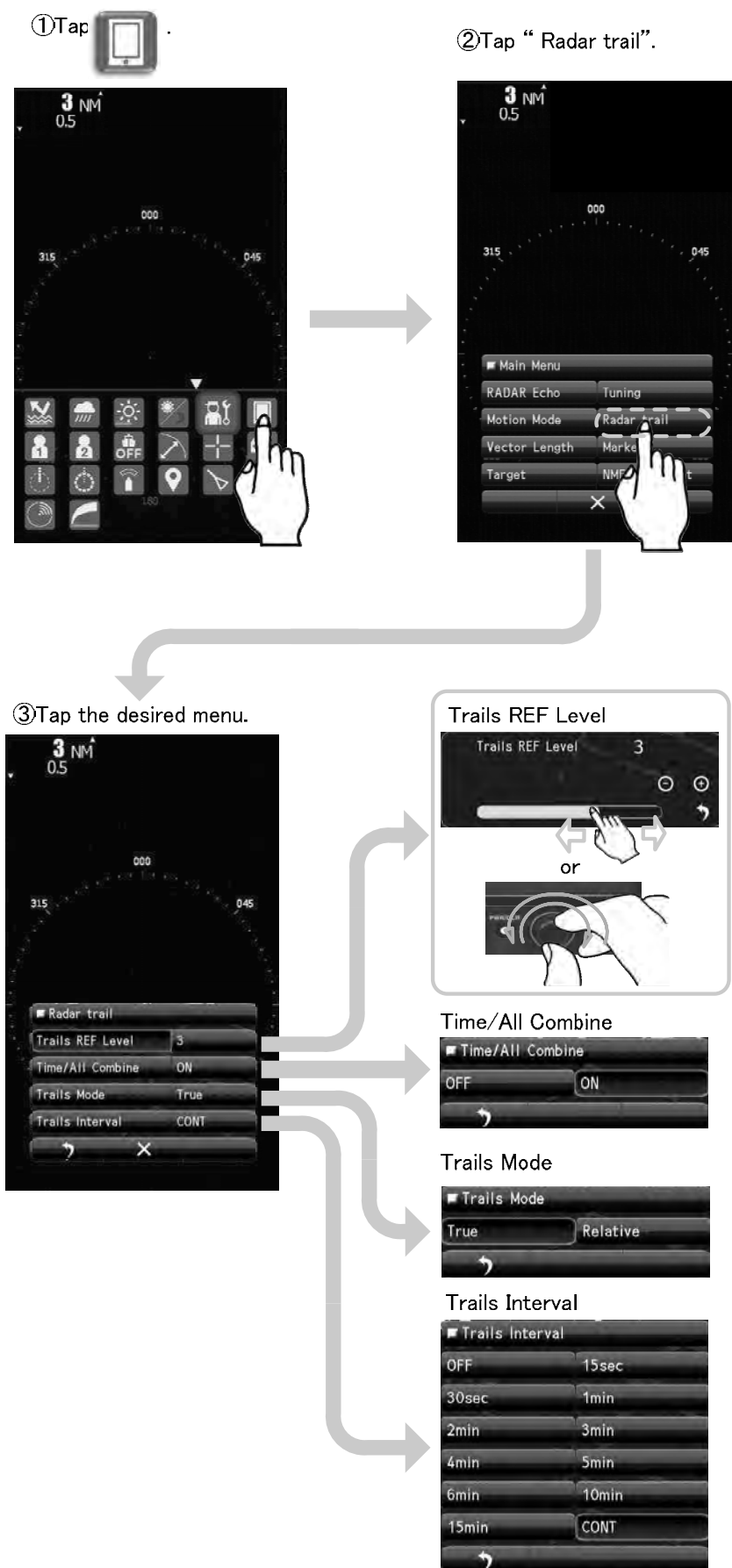

* * * * **FOR REFERENCE** * * * *

Trails REF Level

REF Level1 is the lowest level while “REF Level4” is the highest level. When radar trails are plotted with unwanted waves, change to a higher level.

To thin radar trails, change to a higher level. If radar trails are plotted in snatches, change to lower level.

Time/All Combine

This function superimpose-displays time radar trails and continuous radar trails.

When Time/All Combine Off is selected, this superimposed-display is disabled.

When Time/All Combine ON is selected, this superimposed-display is enable.

Trails Mode

True motion trails*:

The system plots the absolute motion trails of a target, irrespective of own ship’s position. The operator can easily judge the course and speed of the target. The system does not plot the trails of land and other fixed targets.

**True bearing signal input and speed signal input are required to display radar trails in true trail mode.*

Relative motion trails:

The system plots the trails of a target at a position relative to the own ship. The operator can easily judge whether the target is approaching the own ship. While the own ship is moving, the system also plots the trails when the own ship is turning.

Trails Interval

Maximum value of radar trail display time.

Short: When short radar trails are often used in bays and the lakes.

Super Long: When long radar trails are necessary for ocean navigation.

Middle: Middle is for specification between Short and Long.

Continuous trails are available with all the options.

Short: Off/15sec/30sec/1min/2min/3min/4min/5min/6min/10min/15min/CONT

Middle: Off/30sec/1min/2min/3min/4min/5min/6min/10min/15min/30min/CONT

Long: Off/1min/2min/3min/4min/5min/6min/10min/15min/30min/1hour/CONT

Super Long: Off/30min/1hour/2hour/3hour/4hour/5hour/6hour/10hour/12hour/
24hour/CONT

5.6 AIS OPERATIONS

To use this function, ship's heading, position and AIS information are required.

The AIS function shows the targets information on the radar display, using other ships information sent out from the AIS unit.



AIS position signal is detected automatically while the AIS function is turned on.

Tap the AIS symbol, then the details are displayed on the screen.

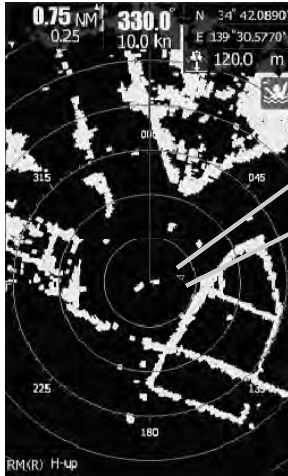

Touch "AIS" symbol.

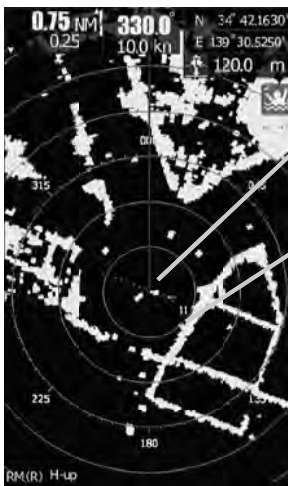

Activated AIS target

This symbol shows the position of an AIS target on the PPI (Plan Position Indicator).

The shape is an isosceles triangle, and its vertex shows the approximate heading direction.

If heading bearing information or COG information is not received, the target is displayed toward PPI.



When selecting an AIS target to display its numeric information, this symbol is superimpose-displayed on the selected target. This is displayed with a split square (basic color is white).

▼ AIS NO.11	CPA 0.1198 NM
BRG 93.1	TCPA -00.0 MIN
COG 260.0	RNG 0.1200 NM
RMS 377470000	SOG 5.0 kn
NAME	
C/S	

The specified target data is displayed.

BRG and RNG shows the relative positional information which is observed from the own ship. COG and SOG shows ground speed and ground course of the target. Position information is measured through the GPS which is equipped to the ship.

Using a long tap operation to release the target detailed data.

The target data will remain on the radar display until the target is lost, or until another target is designated.

The displayed AIS data can be closed by press the CLR button.



CPA: CLOSET POINT of APPROACH

TCPA: TIME to CPA

BRG: Target BEARING from own ship direction

RNG: Target RANGE from own ship position

COG: The ship's course of ground

SOG: The ship's speed of ground

MMSI: The ship's MMSI

NAME: The ship's name

C/S: The ship's CALL SIGN

5.7 TT OPERATIONS



To use this function, ship's heading and GPS signal (COG/SOG) information is required.

The TT function calculates the course and speed of a target by automatically tracking the targets movement. The alarm will sound in a dangerous case.

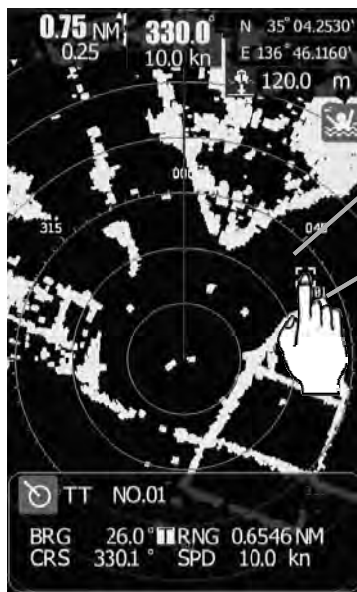

Tap a target which you want to track.

Then a TT symbol mark will be appeared around the target.

Tracked target is numbered automatically.

When the number of targets tracked has reached to the maximum (10 targets), any new target is not acquired.

Delete the unnecessary targets, then acquire new targets.



Tracking target

This symbol is displayed for the target which becomes the tracking target after acquired.

This is displayed with a circle of thick line (basic color is white).

When selecting a tracking target to display its numeric information, this symbol is superimpose-displayed on the selected target.

This is displayed with a split square (basic color is white).

This is superimpose-displayed on tracking targets, new tracking targets or dangerous targets.

Assigned the ID number automatically.

TT Display Example

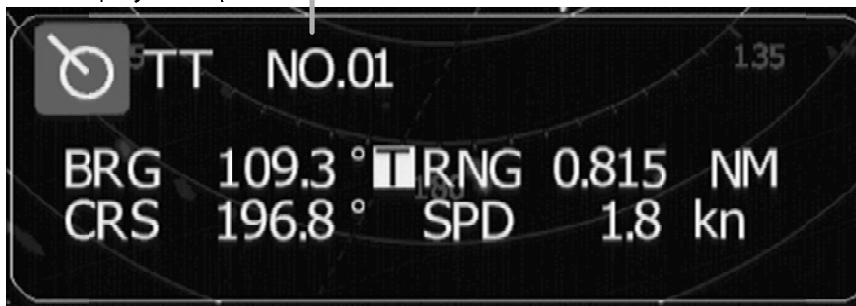

BRG: Target Bearing measured from own ship (True mode or Relative mode).

RNG: Target Range measured from own ship.

CRS: Calculated target course. Calculated from own ship course and target ship course.

SPD: Calculated target speed. Calculated from own ship speed and target ship speed.

The target data will remain on the radar display until the target is lost and its vector disappears, or until another target is designated. The displayed target data can be closed by press the CLR button.

5.8 MODE FUNCTION

Mode function can be set according with different situations.

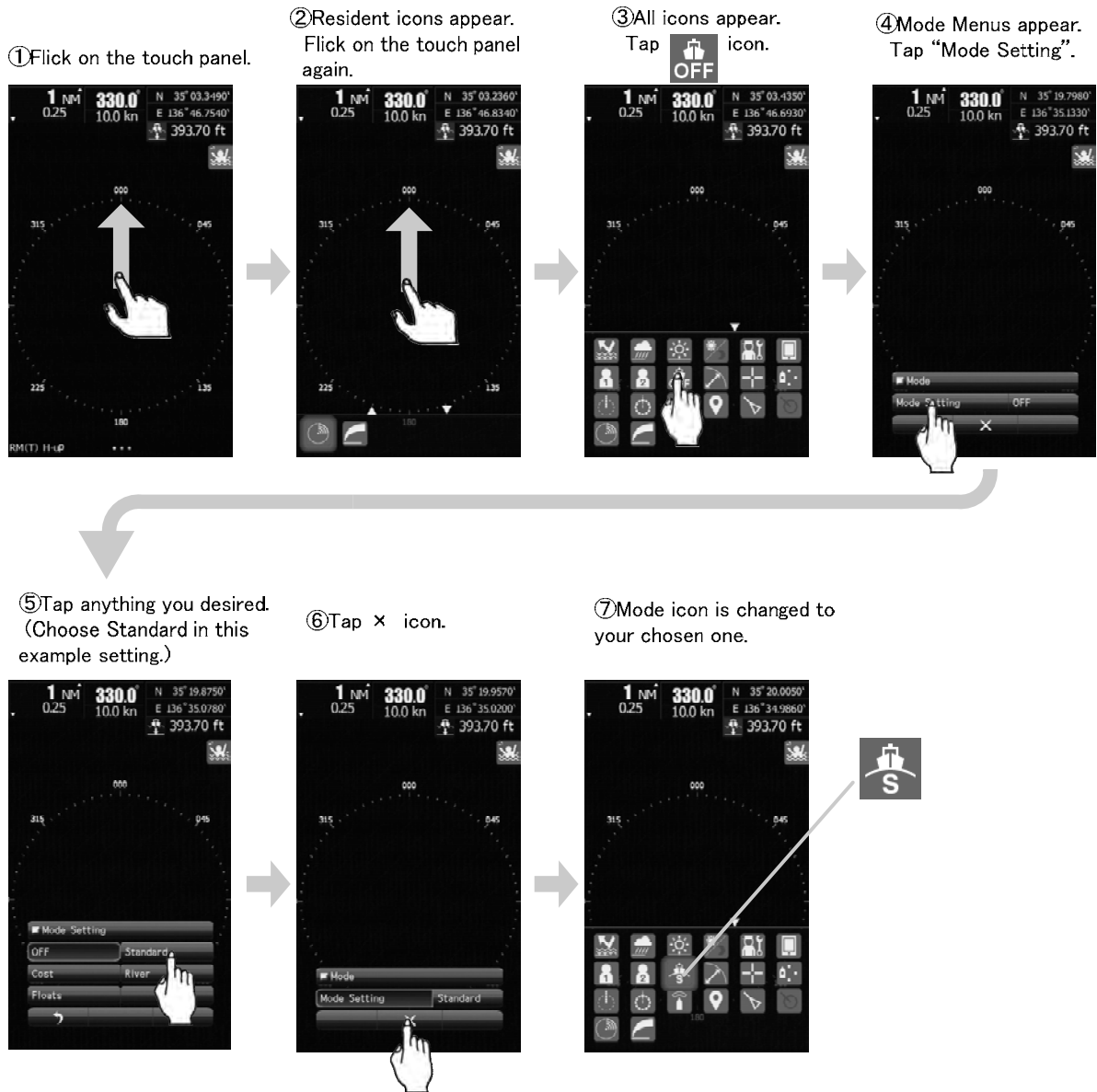

The settings for each mode are following.

Mode Name	OFF	Standard	Coast	Float	River
Setting Contents					
IR	Middle	Middle	Middle	Middle	Middle
Process	Off	Off	Off	5Scan COREL	Off
Target Enhance	Level1	Level2	Level2	Level2	Level2
Auto STC/FTC	Off	Off	Off	Off	Off
Video Latitude	Normal	Normal	Narrow	Wide2	Wide1
Video Noise Rejection	Level1	Level2	Level3	Level1	Level2
Trails interval	Off	Off	3min	3min	Off
Trails mode	Relative	True	True	True	True
Trails REF Level	Level1	Level4	Level4	Level4	Level4
Time / All combine	Off	Off	Off	Off	Off
Max Interval	Short	Short	Short	Short	Short
PRF	Normal	Normal	High Power	Normal	High Power
Antenna Height	default	default	5 to 10m	default	default

5.9 SWITCHING DAY / NIGHT MODE

Combination of the display color and brilliance according to the ambient lighting conditions is provided. The display color setting can be changed easily.

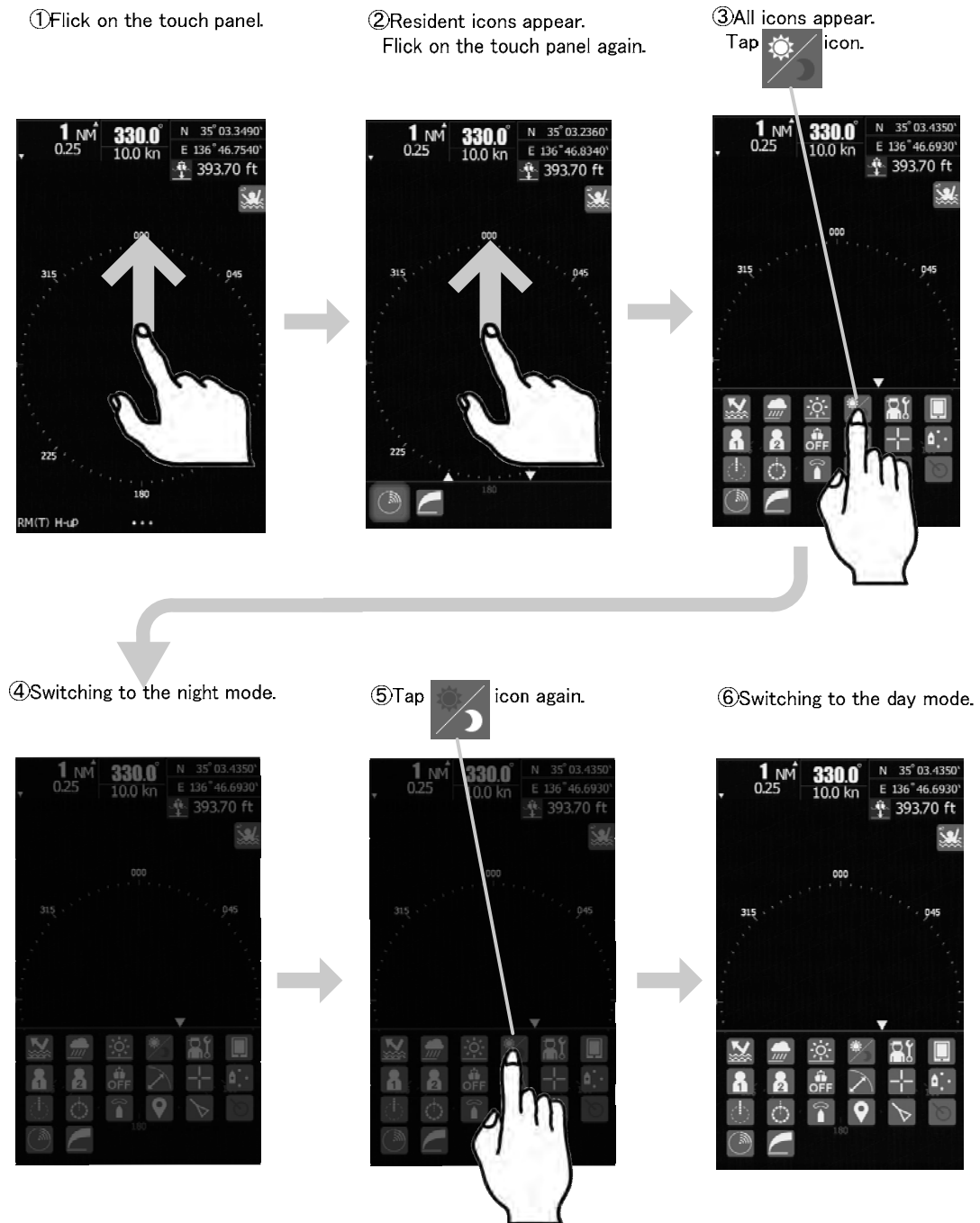

5.10 USER OPTION KEY

For example, it sets User option key on Tuning menu.

① Flick on the touch panel.

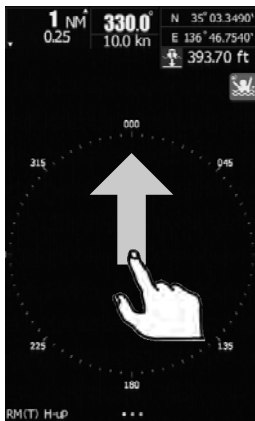

② Resident icons appear. Flick on the touch panel again.

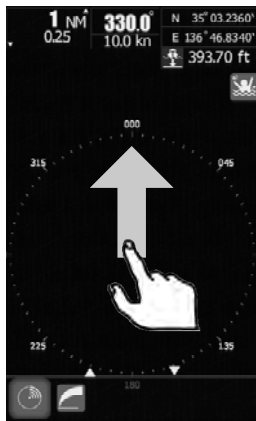

③ All icons appear. Tap [Option Key] icon.

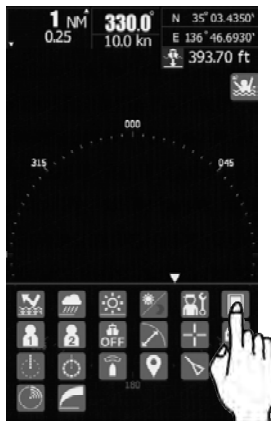

④ Main menu appear. Long Tap "Tuning" menu bar.



⑤ User Key menus appear. Tap [Option Key] icon.

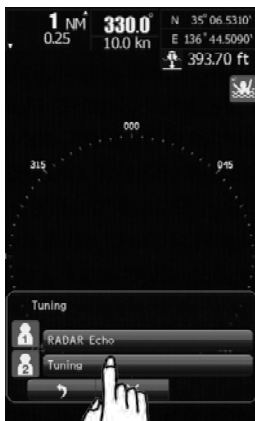

⑥ "Tuning" function is set. Tap X icon to close user key menus.

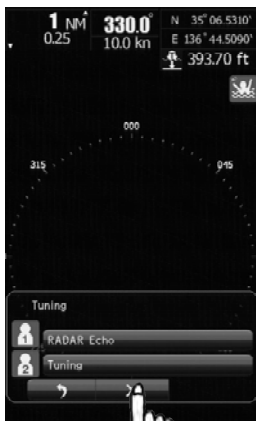

⑦ Tap [Option Key] icon.



⑧ "Tuning" menu appears.

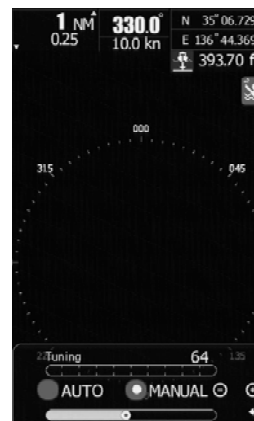

It is possible that you can give your favorite function to the option key .
 By using the option key, you can open the heavily used menu in one operation.
 You can set a function listed in the "bar menu" to an option key as following.
 However, the functions performed by an icon cannot assign to the option key.

Example)

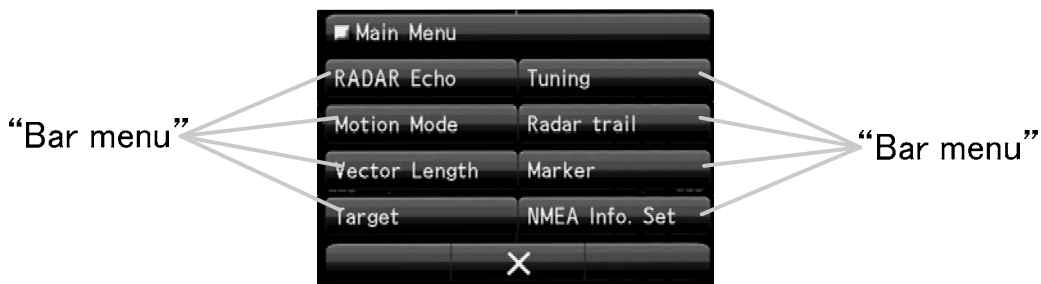

5.11 MARK FUNCTION

5.11.1 MEMO

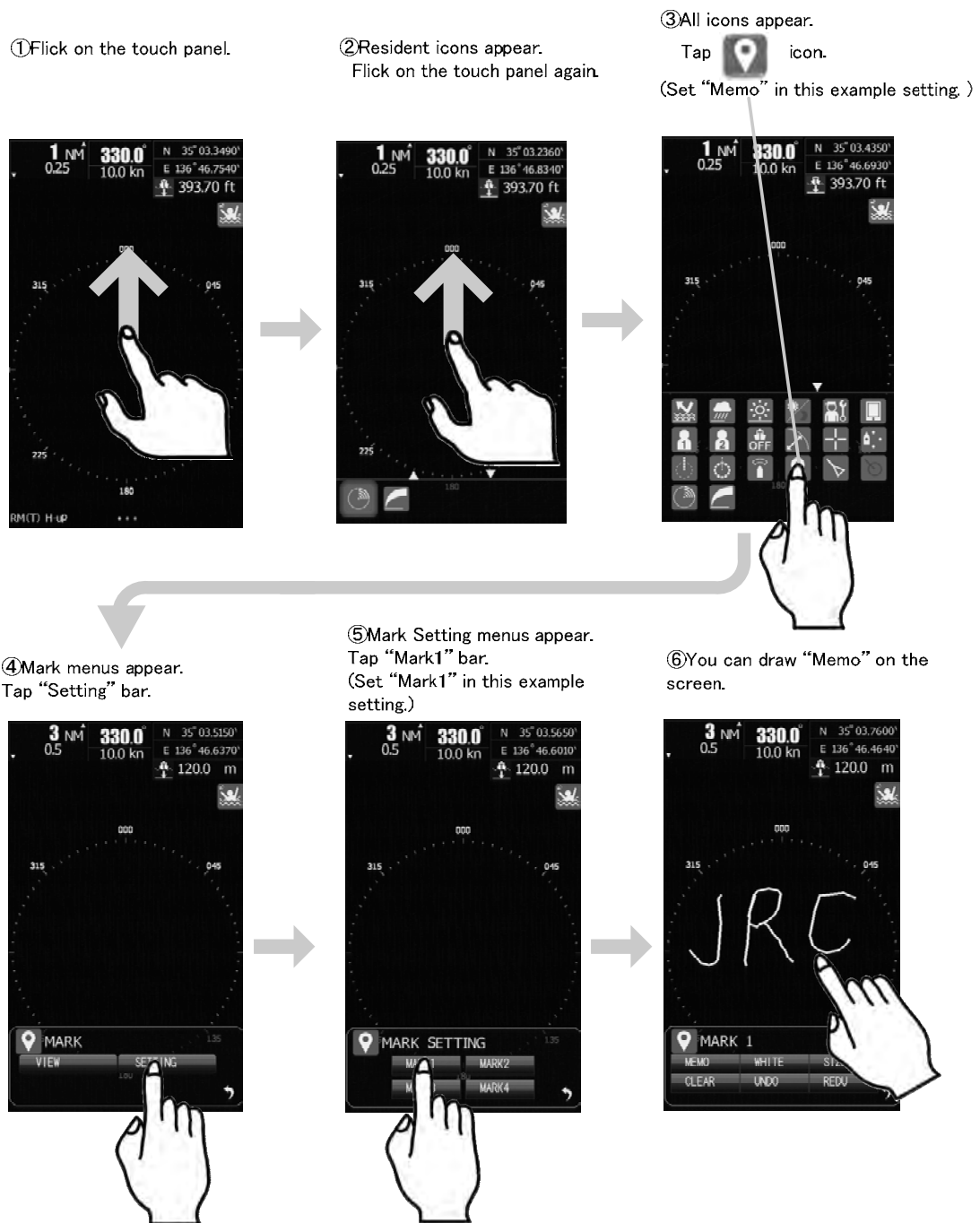

- You can use "Memo" function to draw simple memos on the screen.
- You can change the color and line width of memos.
- You can undo and redo the memos.
- You can delete all the memos by tapping the clear bar.
- You can select a marker to display by tapping the view menu bar.

Numerical of the upper right menu shows the screen points the amount of dots that can be entered. It is possible to enter until 2000 points.

The memos that you made is memorized even after the indicator turned off.

5.11.2 LINE FUNCTION

To use this function, ship's heading and position information are required.

① Click on the touch panel.



② Resident icons appear. Click on the touch panel again.



③ All icons appear. Tap  icon. (Set "Line" in this example setting.)



④ Mark menus appear. Tap "Setting" bar.

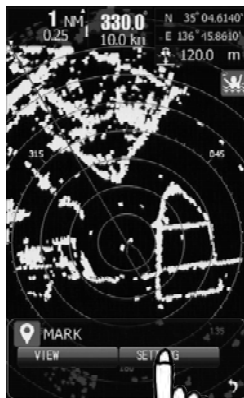

⑤ Mark Setting menus appear. Tap "Mark1" bar. (Set "Mark1" in this example setting.)

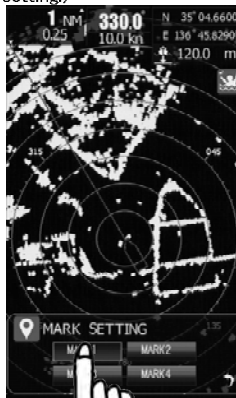

⑥ Maker1 menus appear. Tap the "Line" bar.

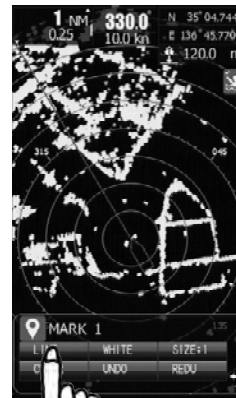

⑦ Users can draw "Line" on the screen.

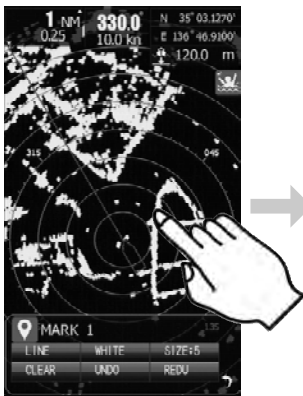

⑧ Tap .

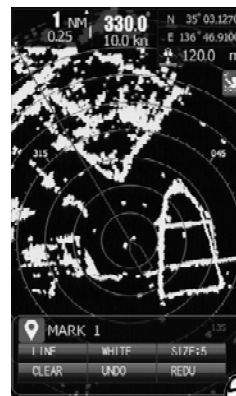

⑨ Return to the Maker Setting menus. Tap .

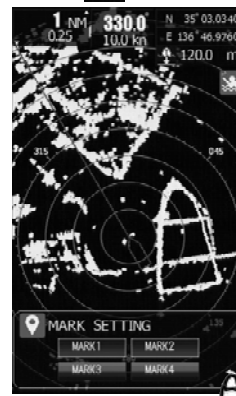

To the next page. →

⑩Return to Maker means.



⑪All icons appear.

Then flick down the screen.

⑫Only resident icons appear.

Then flick down the screen again.

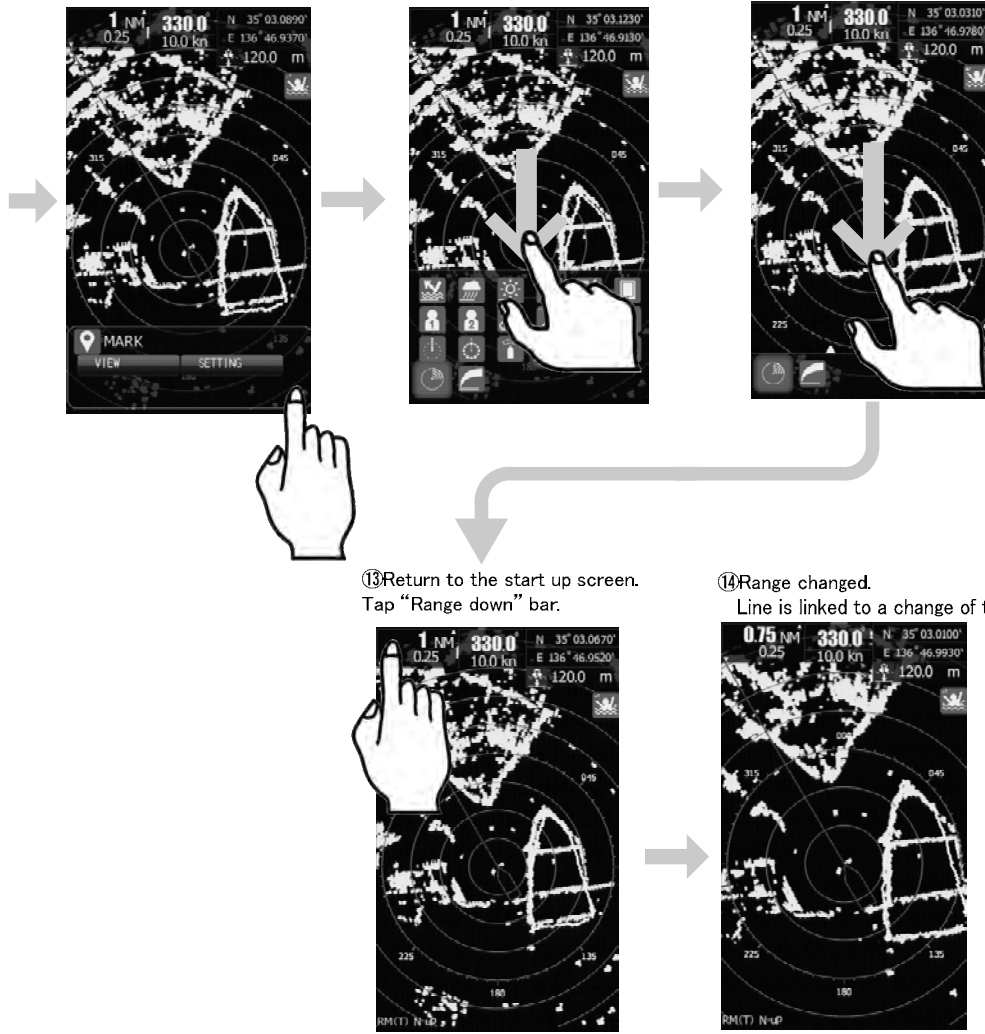

⑬Return to the start up screen.
Tap "Range down" bar.

⑭Range changed.
Line is linked to a change of the range.

You can use "Line" function to draw some lines on the screen.
 There are some differences between "Memo" function and "Line" function as following.
 "Line" function is linked to a change of the range.
 "Memo" function does not.
 To use "Line" function, GPS signal input is necessary.
 "Memo" function need not.
 If no GPS signal is input, you cannot select the "Line" function.

You can change the color and width of lines.
 You can undo and redo the lines.
 You can delete all the lines by tapping the clear bar.
 You can select a marker to display by tapping the view menu bar.

Numerical of the upper right menu shows the screen points the amount of dots that can be entered. It is possible to enter until 2000 points.

The Lines that you made is memorized even after the indicator turned off.

5.11.3 SYMBOL MARKER

To use this function, ship's heading and position information are required.

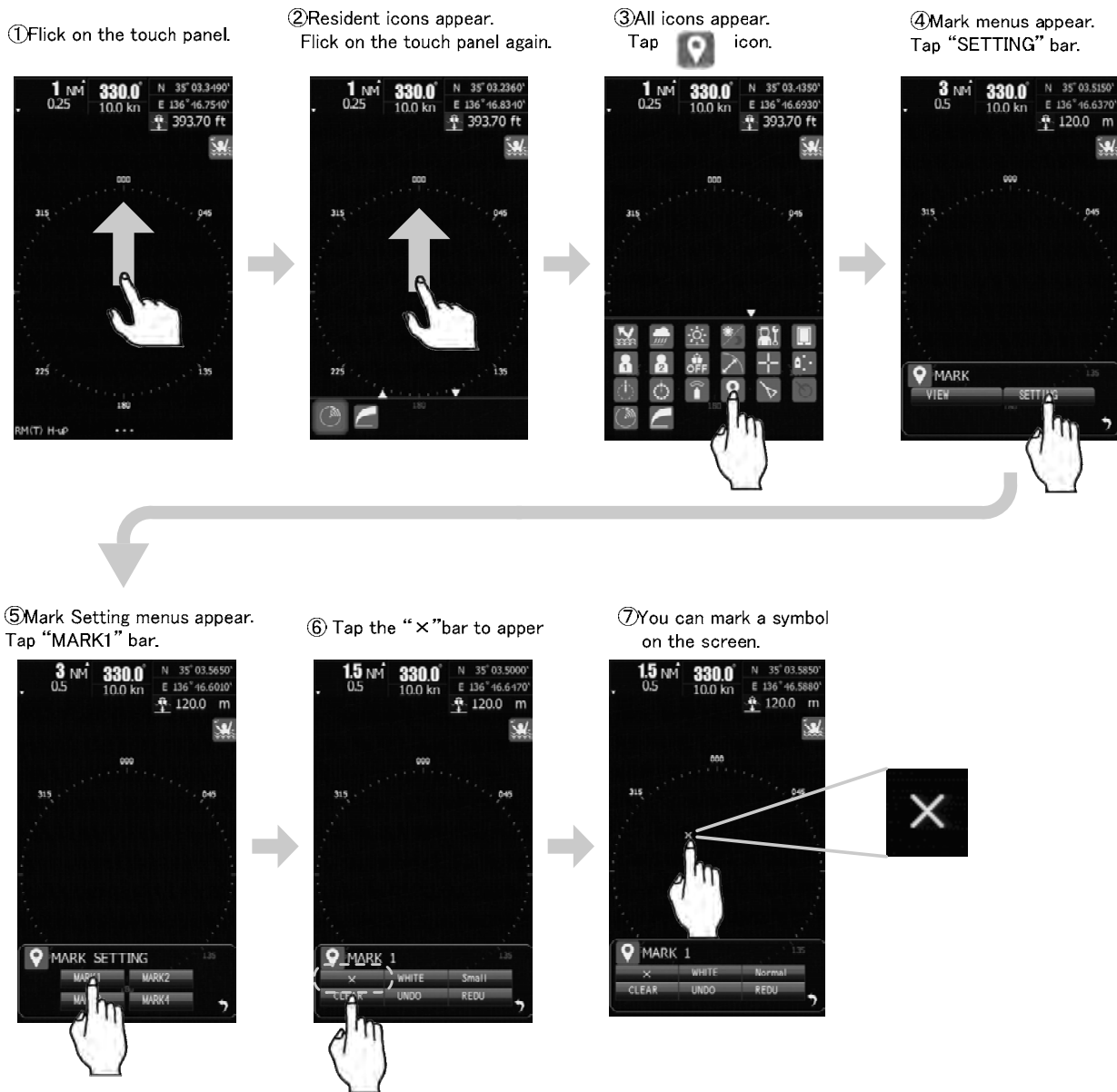

To use the "Symbol marker" function, GPS signal input is necessary because symbol position is memorized as a latitude and longitude data. If no GPS signal is input, you cannot select "Symbol marker" function.

You can select the following symbols.

	Cross-symbol1
	Cross-symbol2
	Y-symbol
	Sandglass-symbol

- You can change the color and size of the markers.
- You can undo and redo the markers.
- You can delete all the markers by tapping the clear bar.
- You can select a marker to display by tapping the view menu bar.
- The maximum number of markers is 2000 points.

The Markers that you inputted is memorized even after the indicator turned off.

5.12 RADAR ECHO

It is used when you want to adjust the settings of your favorite radar image.

① Tap .



② Tap "Radar Echo".



③ Radar Echo menus appear.
Tap each key to adjust the radar echo.

Pulse Length

- Pulse Length
- SP2 MP1

IR(Interference Rejection)

- IR
- OFF Low
- Middle High

Target Enhance

- Target Enhance
- OFF Level1
- Level2 Level3

Process

- Process
- OFF 3Scan COREL
- 4Scan COREL 5Scan COREL
- Remain Peak Hold

Video Latitude

- Video Latitude
- Narrow Normal
- Wide1 Wide2

Video Noise Rejection

- Video Noise Rejection
- OFF Level1
- Level2 Level3

Timed TX

- Timed TX
- OFF ON

5.12.1 PULSE LENGTH

The transmission pulse length is changed by adjusting the range.

Range	Pulse Length(JMA-1032)	Pulse Length(JMA-1034)
0.0625NM	SP1	SP1
0.125NM	SP1	SP1
0.25NM	SP1	SP1
0.5NM	SP1/MP1	SP1/MP1
0.75NM	SP2/MP1	SP2/MP1
1NM	SP2/MP1	SP2/MP1
1.5NM	SP2/MP1/MP2	SP2/MP1/MP2
2NM	SP3/MP1/MP2	SP3/MP1/MP2
3NM	SP3/MP1/MP2	SP3/MP1/MP2
4NM	SP3/MP1/MP2	SP3/MP1/MP2
6NM	MP2/LP1	MP2/LP1/LP2
8NM	MP2/LP1	MP2/LP1/LP2
12NM	MP2/LP1	MP2/LP1/LP2
16NM	MP2/LP1	MP2/LP1/LP2
24NM	LP1	LP2
32NM		LP2
48NM		LP2

SP(Short Pulse): The transmission pulse length becomes shorter, and the range resolution improved. The suppression of sea clutter return or rain/snow clutter return is heightened. Recommended conditions are following.

- In bays / harbors and narrow waterway where targets are densely crowded.
- Rough sea state due to torrential rain or stormy weather.

MP(Middle Pulse): The normal transmission pulse length is set. Both range resolution and sensitivity are appropriately set. Recommended conditions are General navigation.

LP(Long Pulse): The transmission pulse length becomes longer, and sensitivity improved. Small targets are zoomed and are easy to observe. When the sea state is bad, detection performance decreases. Recommended conditions are following.

- Detection of small targets in good weather conditions, at long range.

5.12.2 IR (INTERFERENCE REJECTION)

You can eliminate the interference from other radars by setting an appropriate IR level. However, if a higher IR level is selected, the detection of small targets such as buoys and small boats become difficult. In general "Low" level should be selected.

5.12.3 TARGET ENHANCE

The dimension of video display is enlarged by the target enhancement function. And radar echo display of two targets is closing in angle and distance. As a result, may be displayed in PPI screen as one target.

OFF: Select this mode particularly when resolution is required.

Level1: Select this mode in general.

Expands the radar echo area at 1 step for vertical direction and at 1 step for horizontal direction.

Level2: Select this mode to easily view the radar video.

Expands the radar echo area at 1 step for vertical direction and at 2 steps for horizontal direction.

Level3: Select this mode to detect small targets such as buoys.

Expands the radar echo area at 2 steps for vertical direction and at 3 steps for horizontal direction.

When Level3 is selected, sea clutter returns and rain/snow clutter returns are apt to be enhanced.

When using this enhance mode, operate the



and



to suppress sea clutter returns and rain/snow returns.

In general, Level1 or Level2 should be selected.

5.12.4 PROCESS

This function reduces unnecessary noise to highlight targets. When viewing a radar beacon, SART signal, or fast moving target on the radar display, do not use this function. This function is suitable for using in TM mode. The bearing data input is required for video processing.

OFF: Select this mode in general.

3Scan-COREL: Select this mode when many rain/snow clutter returns are detected.

4Scan-COREL: Select this mode to highlight targets while suppressing sea clutter returns.

5Scan-COREL: Select this mode to detect small targets hidden by sea clutter returns.

Remain: Select this mode when own ship yaws wildly.

Peak Hold: Select this mode to detect small targets of which detection probability is low.

When "COREL" is set, the image becomes smaller. When "Remain" or "Peak Hold" is set, the afterimage will appear.

5.12.5 VIDEO LATITUDE

Select the dynamic range in which receiving signals are to be shown on the radar display.

Narrow: Narrows the dynamic range at short range.

Normal: Standard setting. The dynamic range varies depending on the actual range.

Wide1: Use this mode when rainy weather intensifies unwanted waves. The dynamic range is about twice as wide as when Normal is selected.

Wide2: Use this mode when rain clouds remain even when using Wide1.

Select Normal in standard, and Wide1 in rainy weather. Narrow clearly displays short-range videos when STC is used in manual mode.

5.12.6 VIDEO NOISE REJECTION

This function rejects signals that assumed as noise and clutter in radar videos.

OFF: Turns off the noise rejection function, and displays all signals. Targets are popped up from noise and displayed like analog signals.

Level1: Rejects the signals of definitely unwanted waves (noise and clutter). When detection of targets or unwanted waves in no definite, the signals are displayed. When detection of targets is definite, the signals are displayed.

Level2: Rejects the signals of definitely unwanted waves (noise and clutter). When detection of targets or unwanted waves in no definite, the signals are displayed. When detection of targets is definite, the signals are displayed. It will remove the signal that can be regarded as unnecessary wave of more than level 1.

Level3: Select if “Level1” and “Level2” cannot reject the signals enough.

5.12.7 TIMED TX

This function repeats the TX and Non-TX which set by the initial setting menu.

The rotating of antenna does not stop during the Non-TX.

To enable the timed TX function, you need to set ON Timed TX in this menu after you set ON of Adaptation in initial setting menu (refer to 8.3.5).

OFF: Sets the timed TX function to OFF. **ON:** Sets the timed TX function to ON.

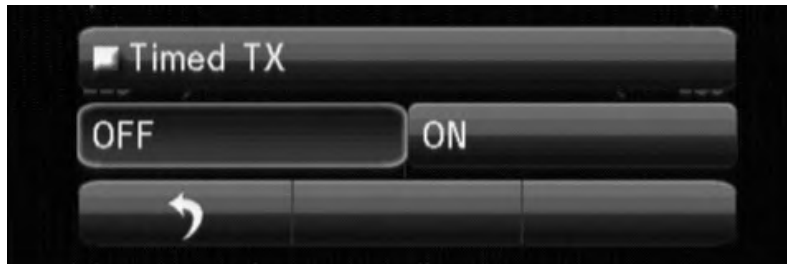

The state mark of Timed TX appears. (Below of left side of display)



Note:

If you execute function of the timed TX, please be careful.

Because if you forget to execute the timed TX, you will misunderstand that radar transmitting was stopped and radar echo disappeared in the transmitting. You must be remembered that you had set on function of Timed TX. Please use timed TX with caution fully.

5.13 TUNING

Automatic tuning mode (AUTO) and manual tuning mode (MANUAL) are provide. In the automatic tuning mode, transmission and receiving frequencies are tuned and adjusted automatically. In the manual tuning mode, tuning is carried out by yourself.

When “AUTO” is selected, the equipment automatically adjust tuning. Tuning is adjusted when the range is changed or pulse length is changed.

When “MANUAL” is selected, adjust the video to be the largest by observing the tune indicator bar. Because the tune indicator bar is the guide during manual tuning, adjust the tune indicator bar to the maximum.

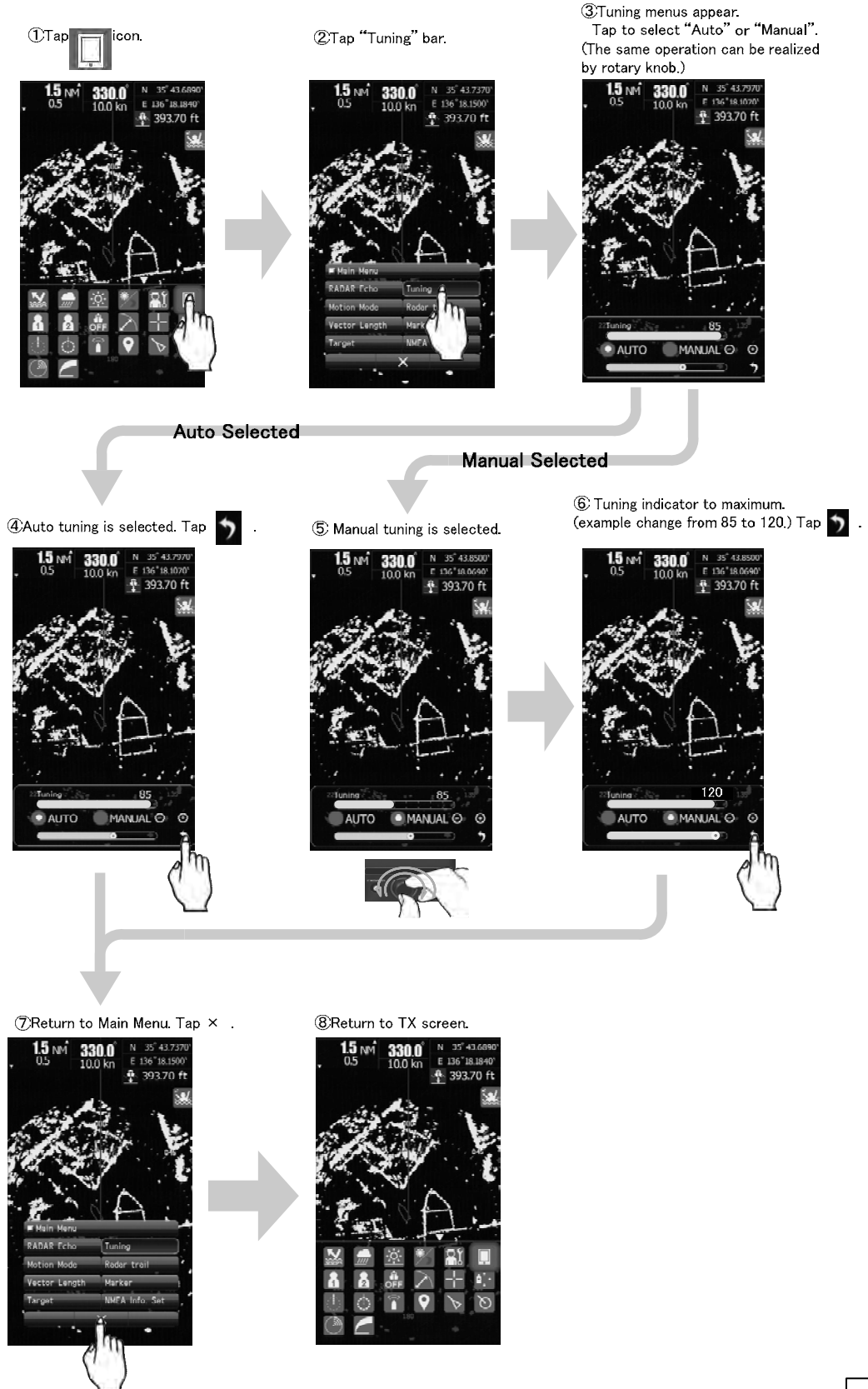

5.14 MOTION MODE

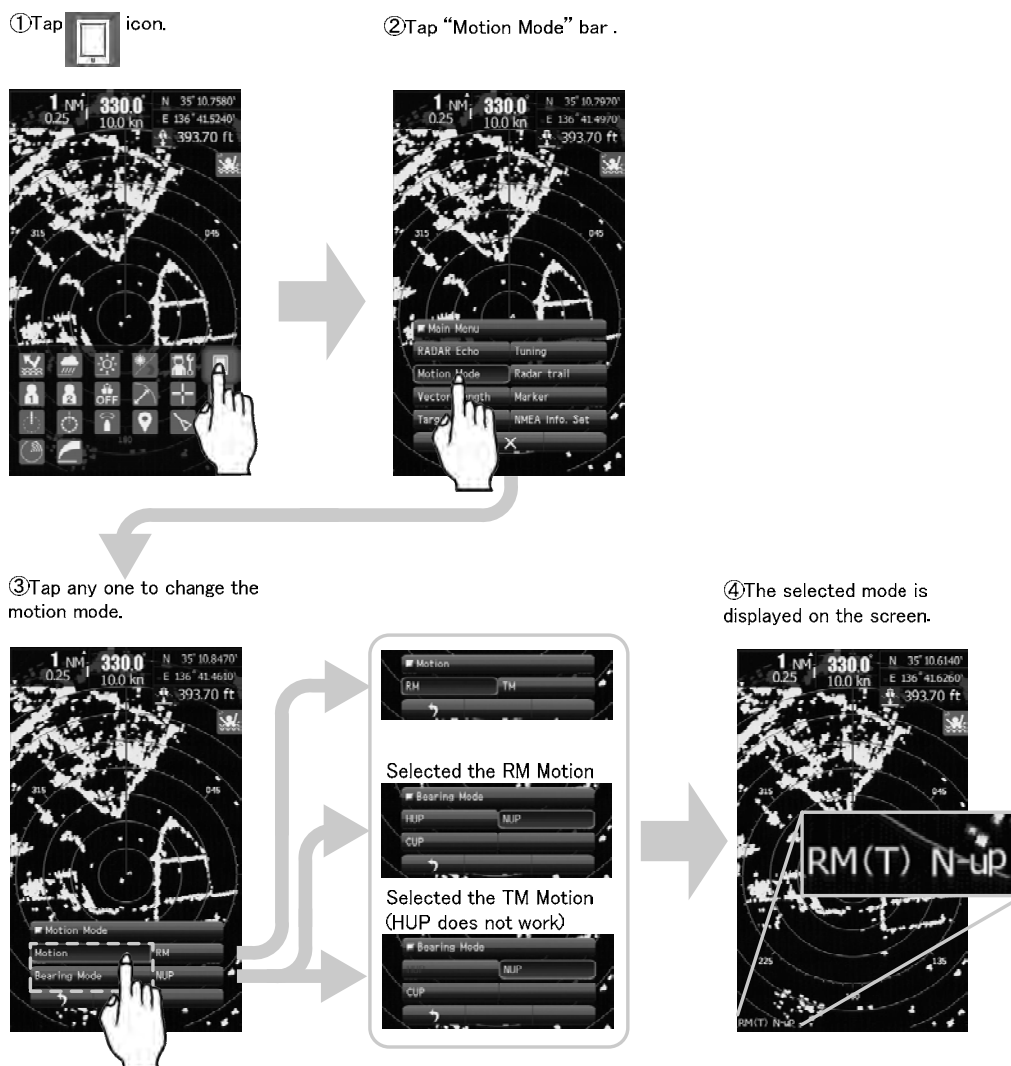

Motion: Switches between true and relative motion display modes. The bearing signal input is required to display true motion.

In the true motion display mode, the own ship's position on the radar screen moves depending on its speed and course and the influence of the current. Land and other fixed targets are fixed on the radar screen and only actually moving targets move on the radar screen.

Bearing mode: Selects the azimuth of the radar video.

The bearing signal input is required to display NUP/CUP.

HUP mode is displayed so that the ship's heading line points to the zenith of the PPI. Since targets are displayed in their direction relative to the ship's heading line, the operator can view the video in the same field of view as in operating the ship at sea. This mode is suitable for watching over other ships.

NUP mode is displayed so that the zenith of the PPI points to the due north. Fixed targets do not flicker and are easily identified on the chart, and the true bearing of a target can easily be read out.

CUP mode is fixed pointing to the zenith of the PPI points to the due north. In the same way as in the NUP mode, fixed targets do not flicker, and are stabilized even if the ship is yawing. The bearing of the heading line varies by the same shift of own ship's course.

5.15 VECTOR LENGTH

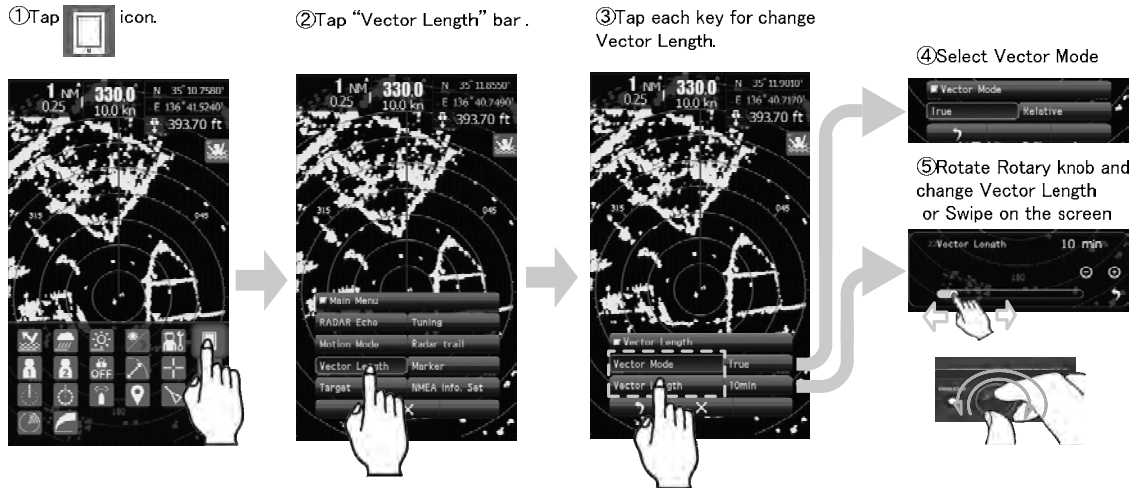

Sets TT and AIS vectors. The bearing and speed signal input are required to display TT and AIS vectors.

In the True vector mode, the direction of a target vector indicates the true course of the target and its vector length is proportional to its speed. In this mode, the movements of other ships around own ship can be accurately and easily monitored.

The relative vector does not represent the true motion of the target, but its relative relation with own ship. This means that a target with its relative vector directed to own ship will be a dangerous target.

The vector length of a target is proportional to its speed, and the vector time can be switched in a range of 1 to 60 minutes.

5.16 MARKER

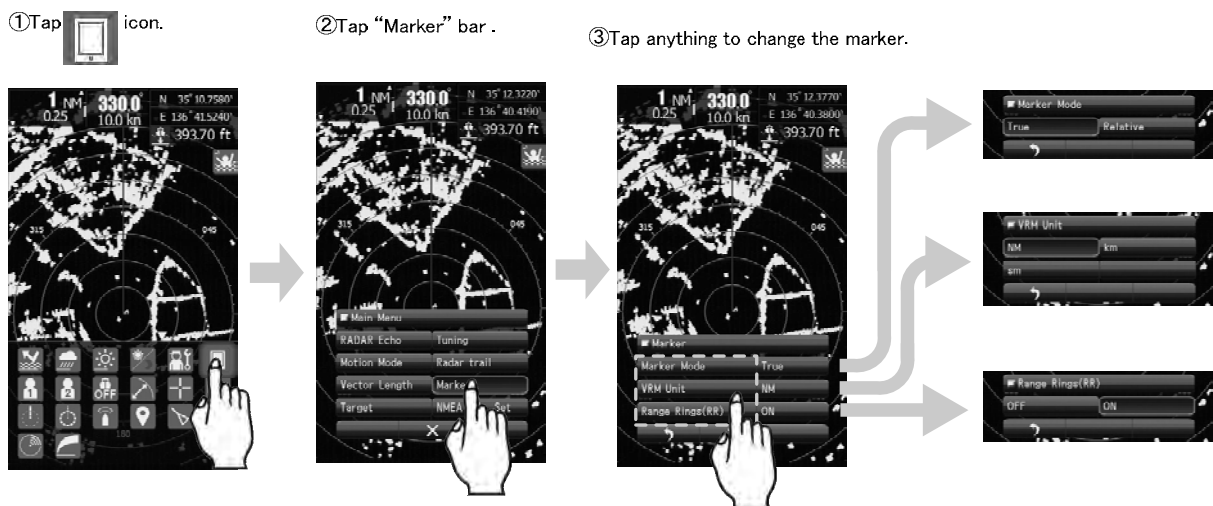

Marker Mode sets whether to display EBLs in true bearing mode or relative bearing mode. Bearing signal input is required to display true mode.

VRM Unit sets unit of VRM range. Range Rings(RR) displays or hides the range rings.

5.17 TARGET

It is used when you want to set about function of target tracking function (TT) and AIS.

① Tap  icon.

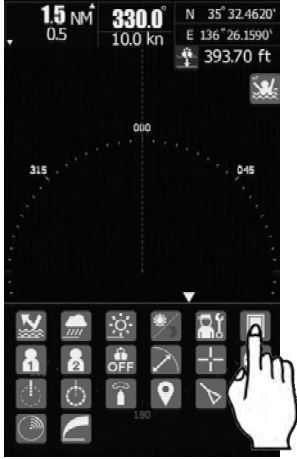

② Tap "Target" bar .

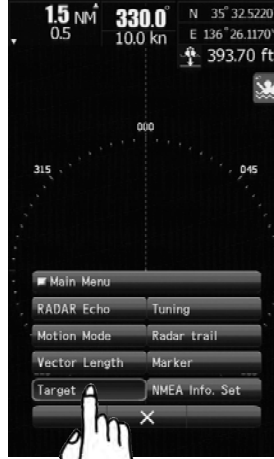

③ Tap anything to adjust the target.



Function ON/OFF



CPA Limit



TCPA Limit



CPA Ring Display



Target Number Display



ALR Alarm From AIS

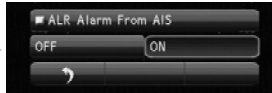

AIS Display Targets



AIS List Display



5.17.1 FUNCTION ON/OFF

Turns ON/OFF TT function and AIS function.

5.17.2 CPA LIMIT

Set and check collision decision criteria before operating.
The CPA Limit value can be set between 0.1 and 9.9NM.

5.17.3 TCPA LIMIT

Set and check collision decision criteria before operating.
The TCPA Limit value can be set between 1 and 99 min.

5.17.4 CPA RING DISPLAY

Sets the CPA ring display. While the distance of the specified CPA Limit value is used as the radius, the CPA ring is displayed with a circle of which center is the own ship's position. The CPA ring is not displayed when the true vector mode is selected.

5.17.5 TARGET NUMBER DISPLAY

A target ID number is a value displayed beside the TT symbol or AIS symbol. These numbers are assigned to targets in acquisition order.

TT is automatically assigned to the 1 to 10 number.

AIS is automatically assigned to the 11 to 60 number.

Each target is identified by the assigned ID number until it is lost or its acquisition is canceled.

5.17.6 ALR ALARM FROM AIS

Sets the display of NMEA ALR sentence received from AIS.

5.17.7 AIS DISPLAY TARGETS

Sets the number of AIS display targets. Set this to get a better look at the screen by limiting the number of AIS symbols.

5.17.8 AIS LIST DISPLAY

Sets the AIS List Display. "ON" is selected, then tap  icon, AIS list displays as following.





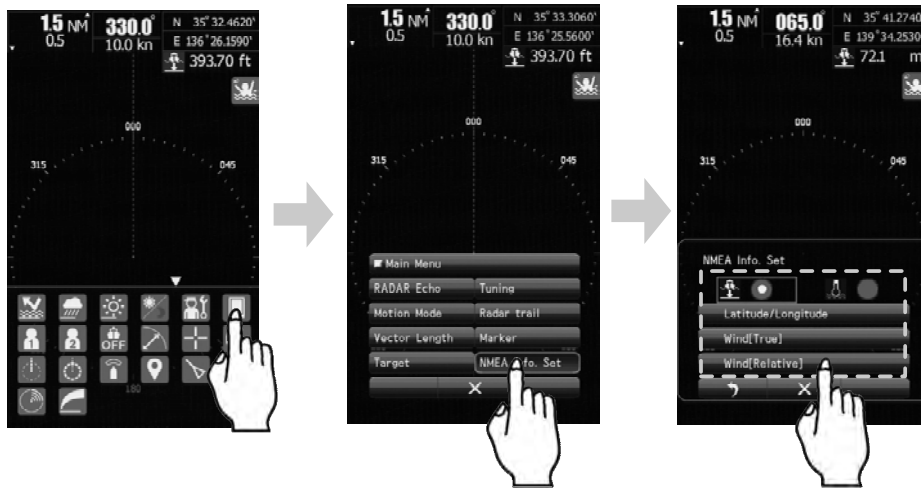

5.18 NMEA INFO. SET

- ① Tap  icon. ② Tap "NMEA Info. Set" bar. ③ Tap anything to change display information.

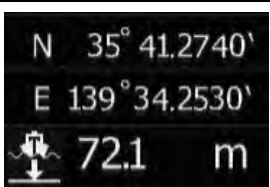
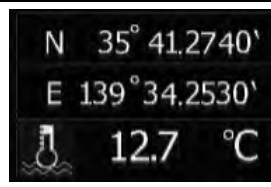
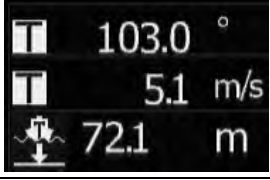

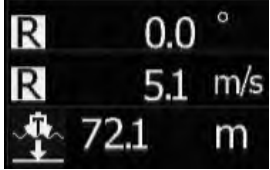
Set the NMEA information displayed in upper right are. NMEA information also can be changed by tapping upper right are. It is possible to display the 6 combinations as following.

Depth and Latitude/Longitude		Temperature and Latitude/Longitude	
Depth and Wind[True]		Temperature and Wind[True]	
Depth and Wind[Relative]		Temperature and Wind[Relative]	

Chapter 6 OPTION FUNCTIONS

6.1 EXTERNAL MONITOR OUTPUT

! CAUTION



If you installed the External monitor output, waterproofing (IPX5) of rear side of display unit is no guaranteed.

In the standard configuration, you cannot use an external monitor. An optional kit “NQA-2447” is provided for JMA-1030 series RADAR. Through the additional interface, you can lead out the video signal to an external monitor. Additional external port is using a D-sub 15 pin connector. External monitor's display pixels are 800x480 dots (WVGA). Any operation on the radar is impossible through the external monitor. It is necessary that power supply to the external monitor separately.

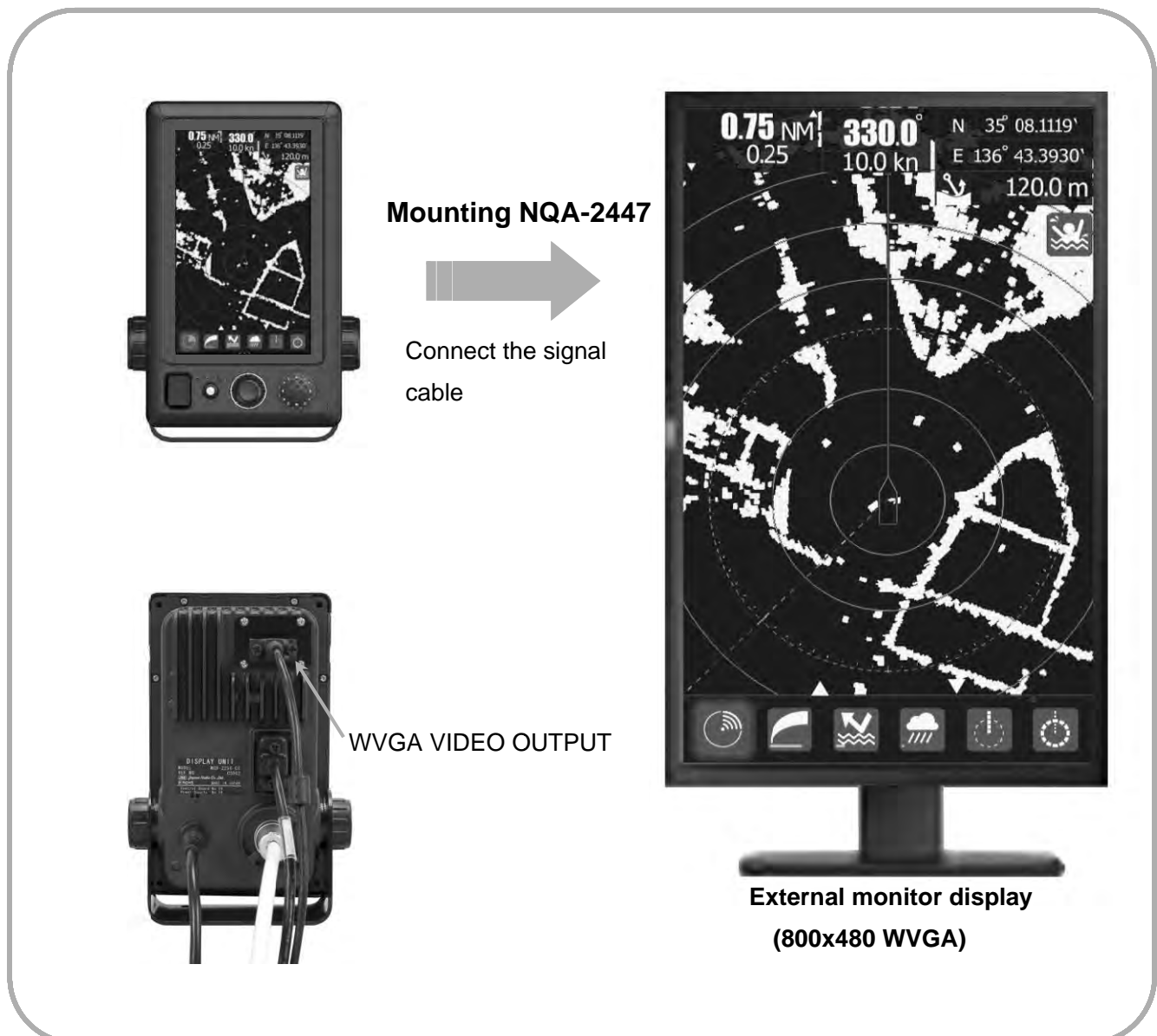

6.2 NMEA CABLE

The JMA-1030 series has 3 channels NMEA signal input allowing connecting to navigation equipment, such as GPS, for own position, waypoints and speed for MARPA tracking. It also allows connecting a GPS compass for your heading (and MARPA tracking) and / or AIS for displaying targets.

In order to use the above function, NMEA cable is required.

- Using JRC GPS receiver, please connect NMEA1.
- Using JRC NSK, please connect NMEA3.
- AIS connects all NMEA port available.

The data are received by IEC61162-1/2.

Telecommunications standard	NMEA0183 / IEC61162-1/2 is not conformity at all
Communications protocol	4800 bps, start 1bit, data 8bit, stop 1bit, With no parity
Input sentence	NMEA0183: V1.5: GGA/ GLL/ RMC V2.0: GGA/G LL/ RMC/ZDA V2.3: GGA/GLL/RMC/GNS/ZDA (Talker= "G P" etc.)
Information classification	about a ship -- the time entry; -- GGA/G NS/G LL/RMC Day and time entry: ZDA Time entry of equipment: ZDA/GGA/GNS/GLL/RMC

IEC61162-1 / 2 (considerable) Priority of data :

L/L:	GGA>RMC>RMA>GNS>GLL	
SOG/COG:	RMC>RMA>VTG	
Log speed:	VBW>VHW	Bearing signal
HEADING:	THS>HDT>HDG>HDM	JRC-NSK format (JLR-10/20/30)
DEPTH:	DPT>DBT	IEC61162-1/2(considerable)
WATER TEMP:	MTW	4800bps/38400bps:THS>HDT>HDG>HDM
AIS:	VDM,VDO,ALR	
WIND:	MWV>VWT,VWR	Speed signal
WAYPOINT:	RMB>BWC>BWR	IEC61162 4800 bps :VBW, VHW

6.3 RECTIFIER UNIT

The input voltage range is from DC +10.8V to DC +31.2V. (DC12-24V, -10%+30%).Power dissipation is about 50W. If ship's DC battery power supply is not enough to the operation of this radar, we strongly recommended that to you use this rectifier unit.

AC /DC power converter unit : NBD-865.

NBD-865 specification

Input voltage range	AC100/220V
Output voltage range	DC24V

Chapter 7 INITIAL SETTINGS

An initial adjustment had been done for this radar at the factory. This product will be shipped in a usable state. However, in the case you want to configure it with your favorite, please set it by referring to this chapter. It is recommended that you save to USB memory (see 8.5.6.1) or you keep a note of the setting by the user for return to the previous setting.

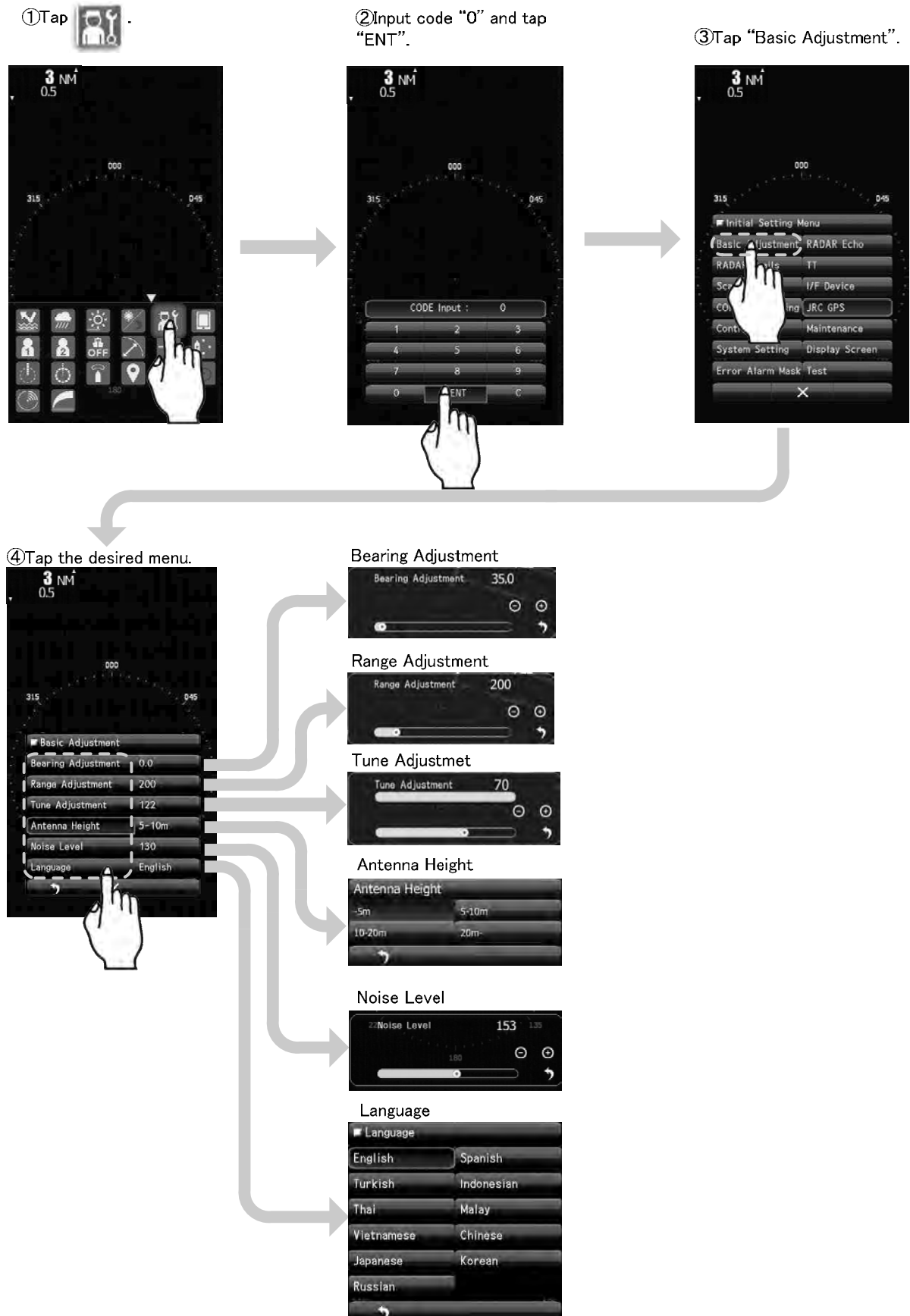

7.1 LANGUAGE SELECTION

Tap “Language” bar.



Choose a familiar language.



If you choose the language that you can't understand, it is able to return to the English menu to input “2256” at the code input menu. At that time, please reselect the language.

7.2 TUNING ADJUSTMENT

The physical dimensions of the magnetron tube in the transmitter dictate the precise transmitter output frequency of the particular set.

The tuning function control fine-tunes the receiver circuits to match their maximum sensitivity to that transmitted signal. Tuning adjustment is necessary for maintaining a high performance.

But the tuning adjustment had been already set at the factory. You should not change this adjustment value greatly when you started up the radar at first.

① Tap “Tune Adjustment”.
Set the Range 24NM or more.



② Rotate the Rotary knob to set the tuning.

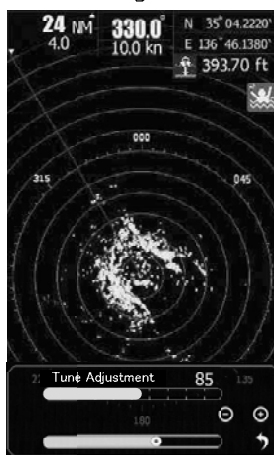

③ Adjust “Tune bar” so as to have eight or more scale.

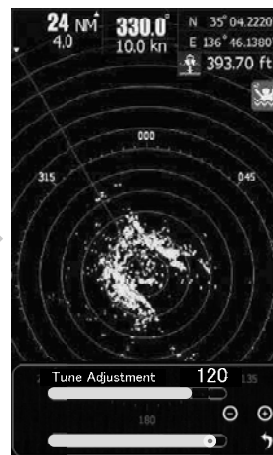

7.3 BEARING ADJUSTMENT

Adjust the bearing so that bearing of the target measured with the ship's compass matches that of the target echo on the radar display.

Before adjustment

Measure the bearing of an adequate target (for example, a ship at anchor, a breakwater or a buoy) relative to own ship's heading.

Procedure

- (1) Radar is set to TX mode.
- (2) Adjust GAIN, RAIN and SEA to find the known target on the screen.
- (3) Adjust the bearing at the end point to display the target described in "Before adjustment" at the same direction as measured.

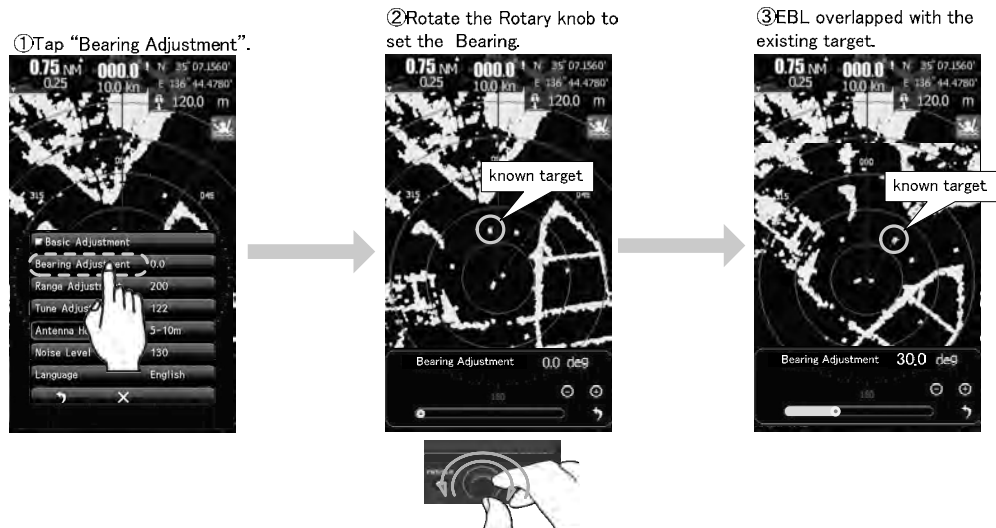

7.4 RANGE ADJUSTMENT

Adjust the range so that the range of the target on the radar video is indicated correctly. This set up is make the target RANGE coincident with the VRM readout data. Read out the target range by the VRM function.

The target has the same height with the radar scanner should be better.

Range unit is using the NM in marine radar usually. (1NM=1852m).

Before adjustment

Select a target which range is already known.

Procedure

- (1) Radar is set to TX mode.
- (2) Adjust GAIN, RAIN and SEA to find the known target on the screen.
- (3) Adjust the range on the radar to match to the range of the target described in "Before adjustment".

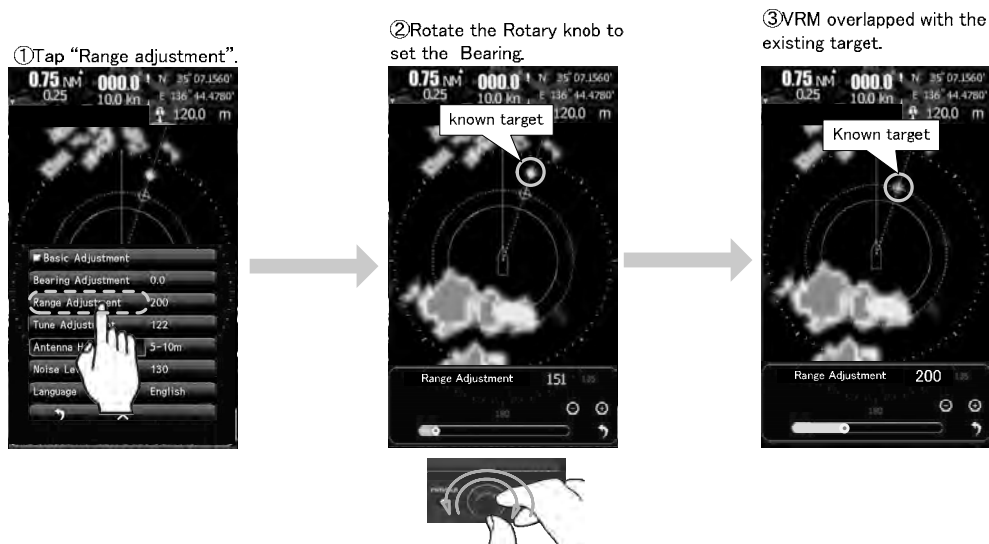

7.5 ANTENNA HEIGHT SET UP

Set up the antenna height.

This set up is related to sea clutter rejection control,

At a short range, sea clutter level is proportion to the height of the scanner.

So an optimum sea clutter rejection constant must be selected according with the height of antenna.

① Tap "Antenna Height".



② Select antenna height.



7.6 NOISE LEVEL

The noise level had been adjusted at the factory.

When you adjust the noise level after installation, perform only fine-tuning within ± 5 .

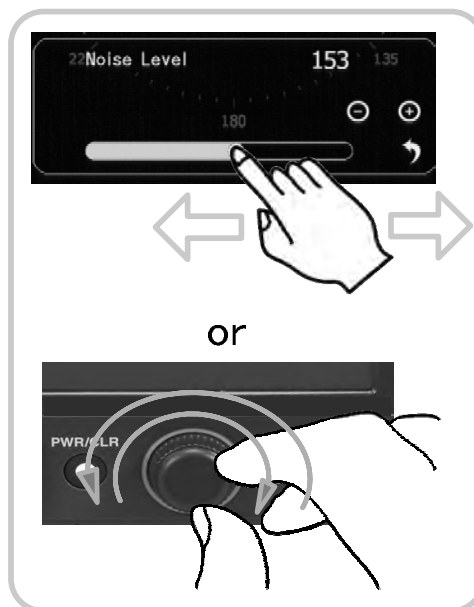
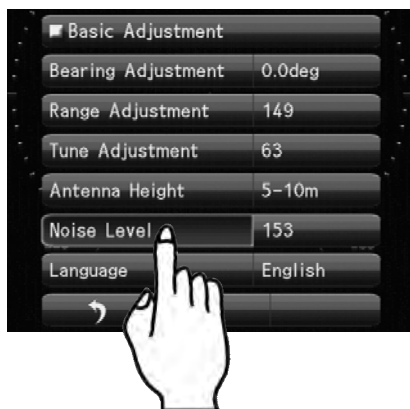

7.7 COMMUNICATION PORT SETUP

Set up the communication port to communicate external device.

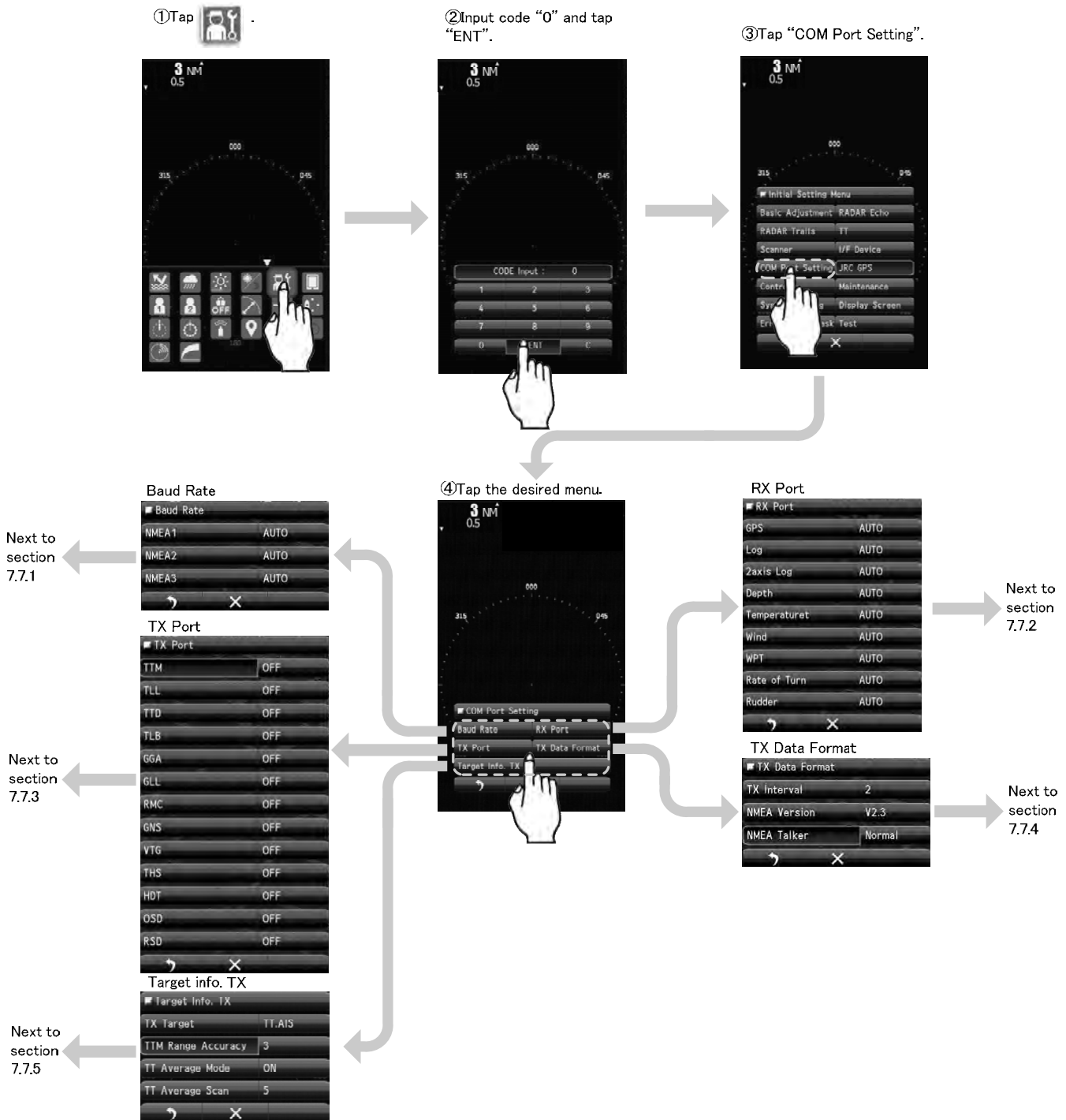

7.7.1 BAUD RATE

Data speed setting of communication.

Auto: Switching automatically between 4800bps and 38400bps.

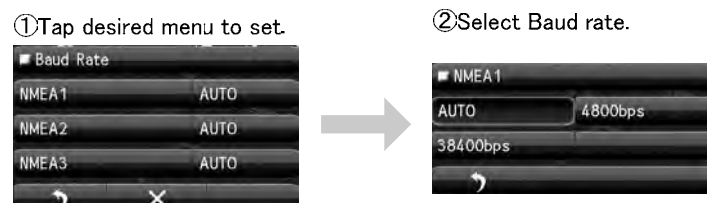

7.7.2 RX PORT

Choose the receive port of each signal. It sets to automatic when there is no particular problem.
 Auto: Switching automatically between NMEA1, NMEA2, and NMEA3.

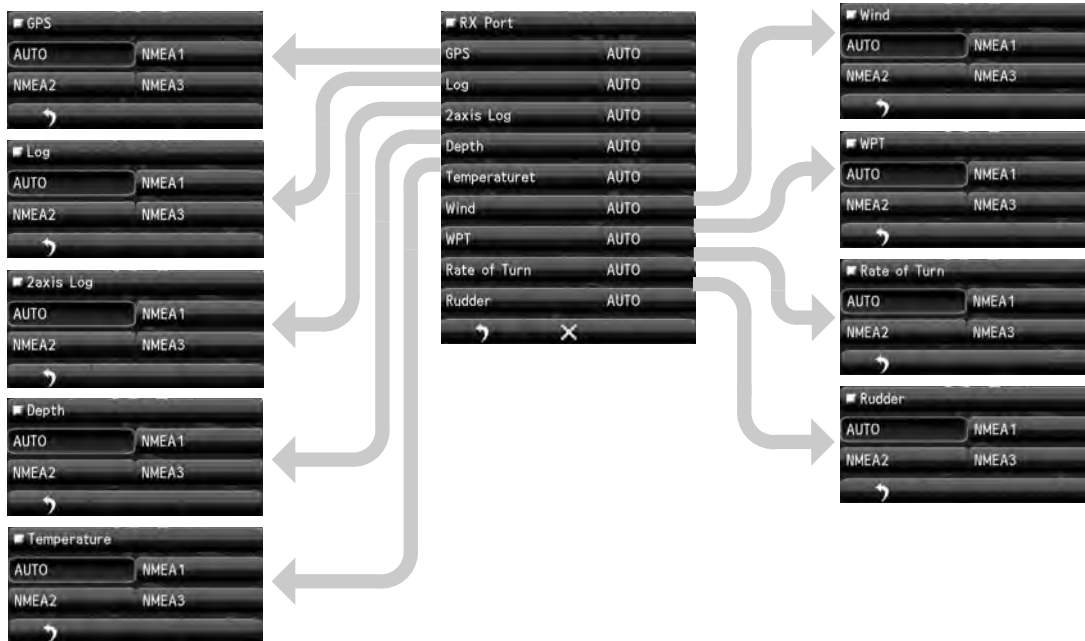

7.7.3 TX PORT

Choose the transmit port of each signal.

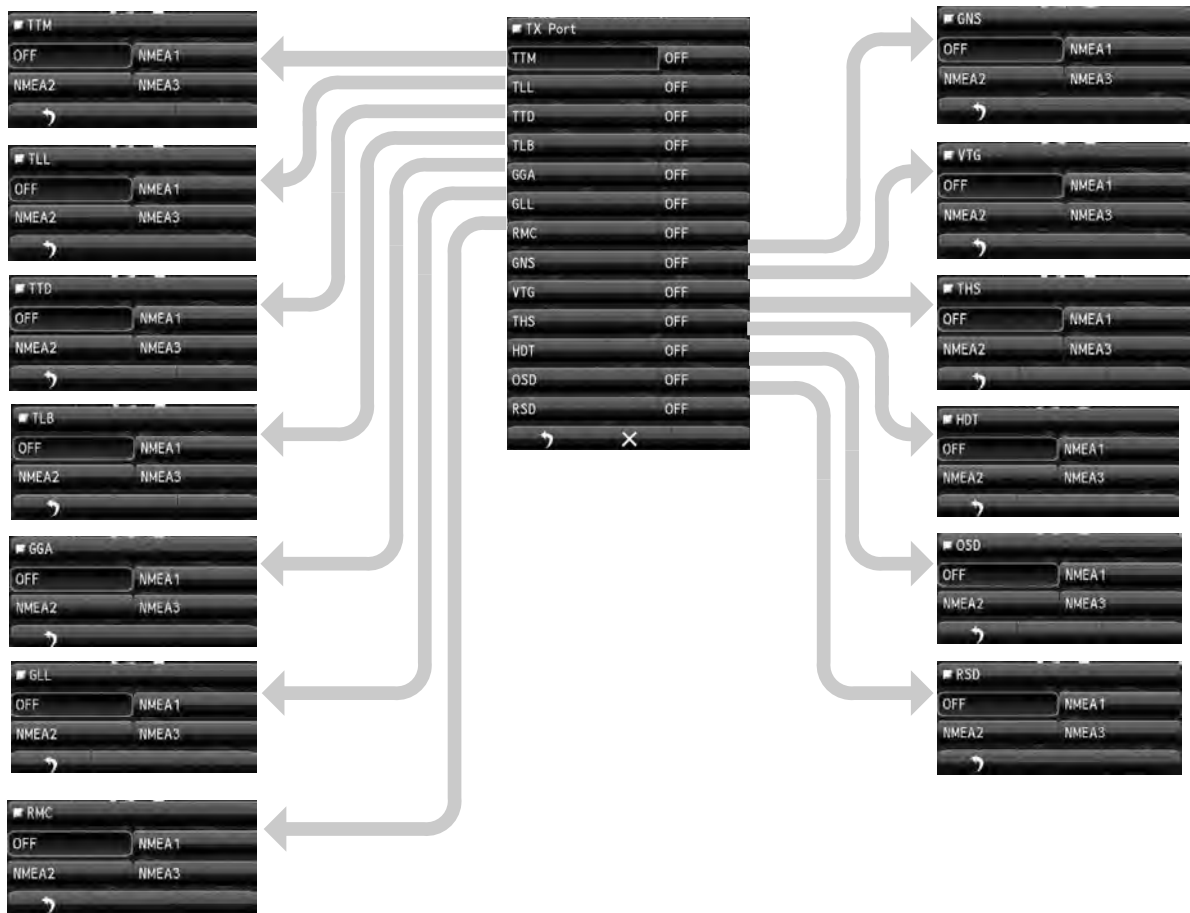

7.7.4 TX DATA FORMAT

It sets the NMEA format of the transmission data to be transmitted from the transmission port.

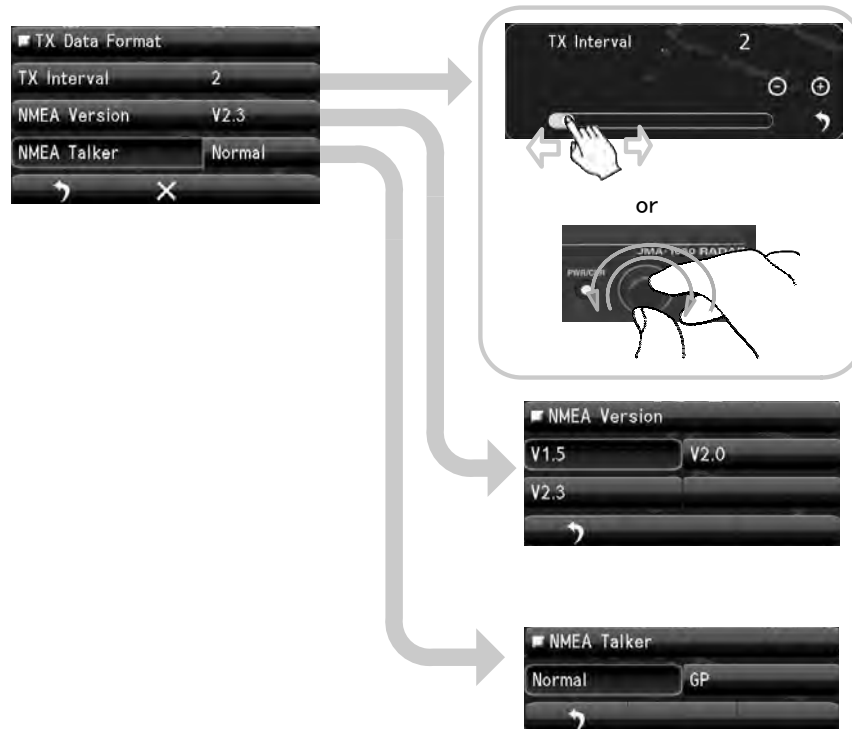

7.7.5 TARGET INFORMATION TX

Set this menu when you want to send from the NMEA port sending the information of the ship and target that was acquired by the AIS and (TT) target tracking function.

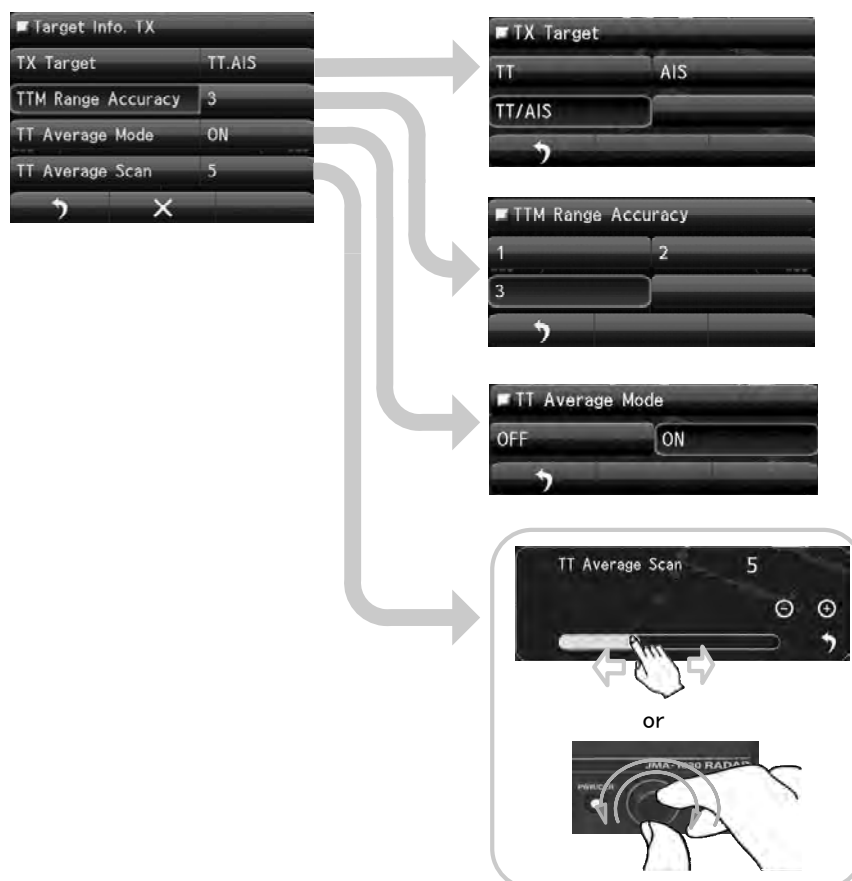

7.8 I/F DEVICE

Make an appropriate setting for each type of equipment when inputting true bearing signals, true bearing data, and speed data.

Settings and parameters are different for each type of equipment.

Make settings for the type of equipment to be connected.

① Tap .



② Input code "0" and tap "ENT".



③ Tap "I/F Device".



④ Tap the desired menu.

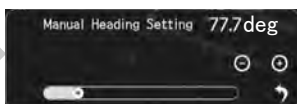
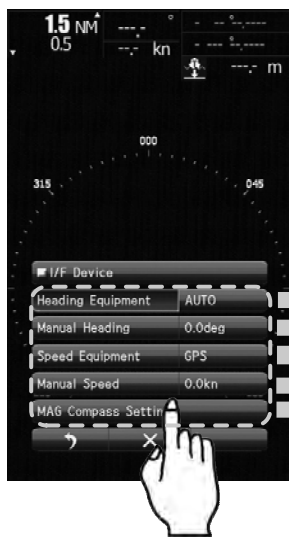

Next to section 7.8.5

7.8.1 HEADING EQUIPMENT

Selects the input of the course data of own ship. The course data of own ship can be selected from the course information of manual input, GYRO, Compass and GPS.

For automatic input, select an equipment which can receive the following sentences.

THS>HDT>HDG>HDM

For manual input, the course information manually set in "MANUAL HEADING" can be used.

GYRO: Input the course data of own ship from GYRO interface.

Compass: Input the course data of own ship from GPS compass or electronic compass.

GPS: Input the course data of own ship from GPS receiver.

7.8.2 MANUAL HEADING

When 7.8.1(Heading equipment) is selected manual, please input bearing value. Some functions that require course information by the manual setting value set will be operational, but please do never forget that it is running in head up always.

7.8.3 SPEED EQUIPMENT

Selects the input of the speed data of own ship.

GPS: Input the speed data of own ship from GPS receiver.

Log: Input the speed data of heading direction from 1-axis log.

2axis Log: Input the speed data of heading and lateral direction from 2-axis log.*

For manual input, the course information manually set in "MANUAL SPEED" can be used.

*2-axis log cannot be effective when the sentence VBW of NMEA0183 is not entered.

7.8.4 MANUAL SPEED

When 7.8.3 (Speed equipment) is selected manual, please input speed value. Manual setting value is used in the processing of internal. The value that affects the relative length of radar trail and vector. Please do not use it in the actual operation.

7.8.5 MAGNETIC COMPASS

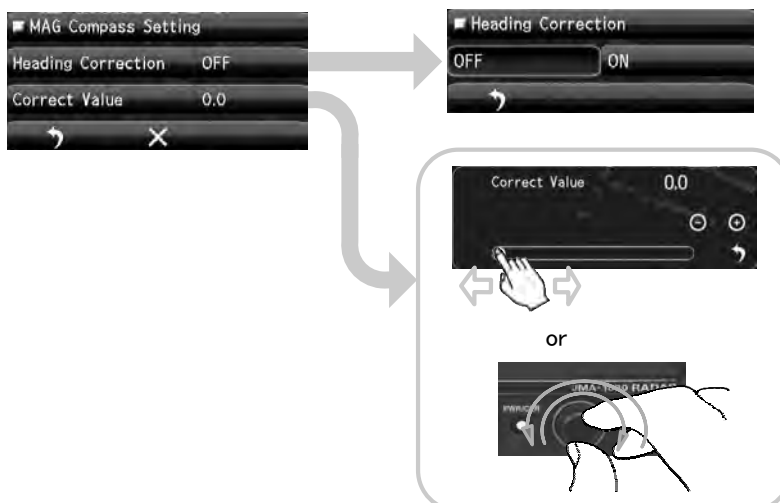

This item is set as to whether or not the heading bearing is to be corrected.

Switches between On and Off.

7.9 JRC GPS (for future enhancements)

This function is currently not available. Will be implemented with future version of hardware /software.

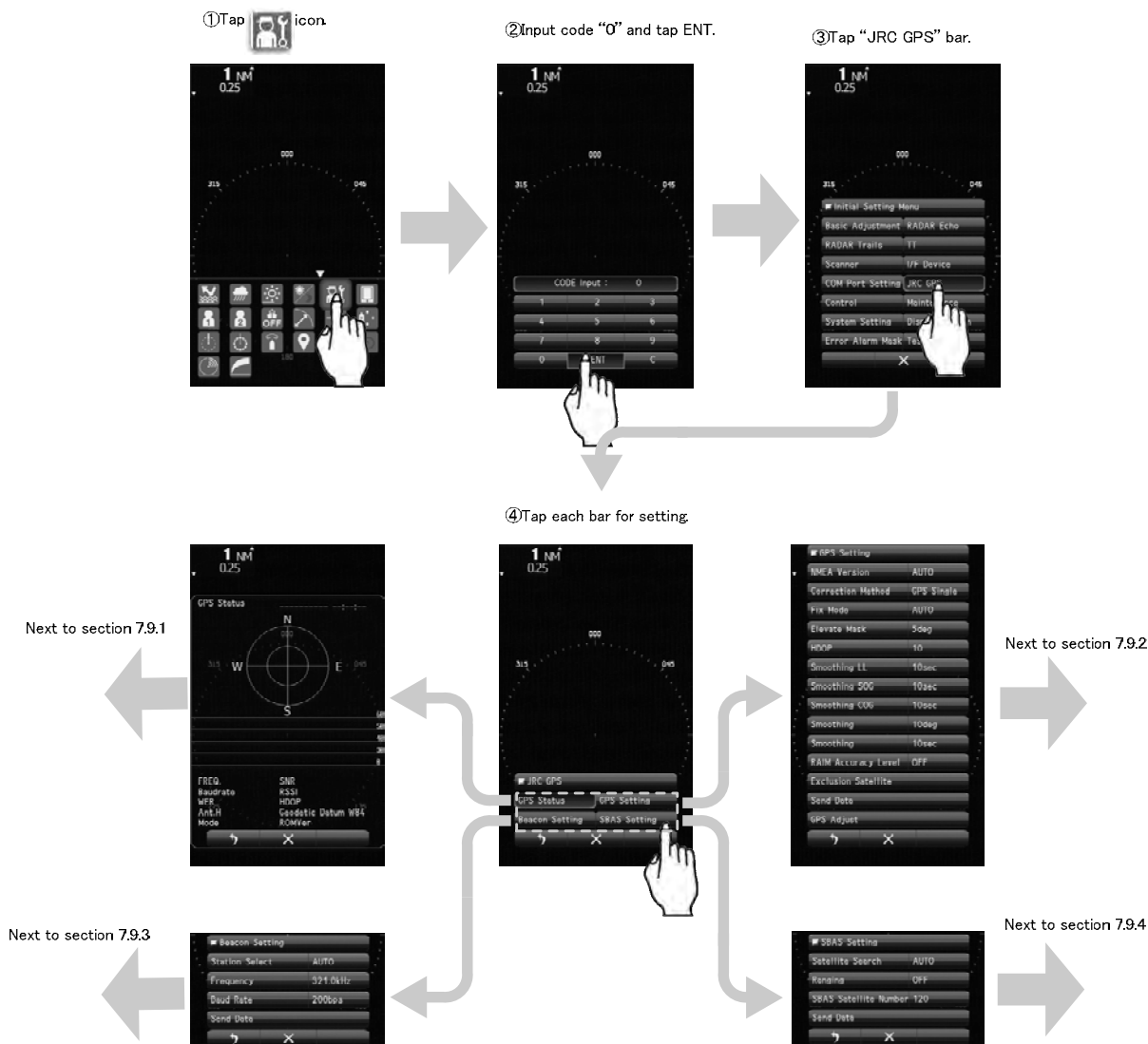

This setting is available only JRC GPS receivers directly connected to the connector for which "GPS" is engraved at the rear of the cabinet.

7.9.1 GPS STATUS DISPLAY

Display the reception status of the GPS receivers (GPS, DGPS and WAAS receivers) currently connected. This setting is available only for JRC GPS/DGPS/WAAS receiver directly connected to the connector for which "GPS" is engraved at the cabinet. This function cannot indicate with transmission state.

7.9.2 GPS SETTING

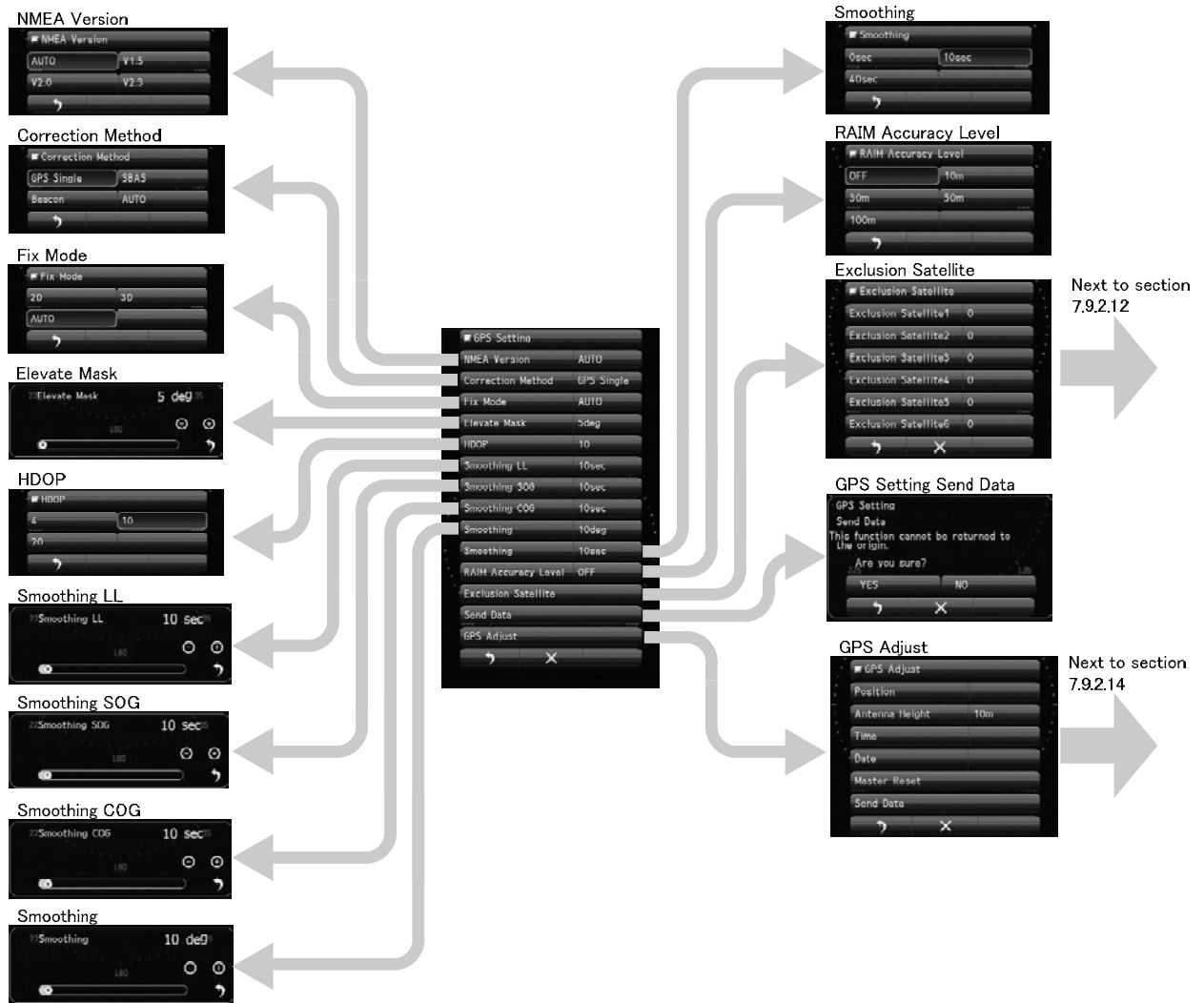

7.9.2.1 NMEA VERSION

Set the NMEA version of GPS output sentence. When the “AUTO” mode is selected, NMEA version of the connected equipment is automatically detected.

7.9.2.2 CORRECTION METHOD

Set the correction method. When SBAS is selected, the GPS receiver must be compatible with SBAS.

GPS Single: Fix a position only with single GPS. Does not perform fixing with SBAS or beacon.

SBAS: Fix a position with SBAS or single GPS. Does not perform fixing with beacon.

Beacon: Fix a position with beacon or single GPS. Does not perform fixing with SBAS.

AUTO: The optimum setting is selected from single GPS, SBAS and beacon.

7.9.2.3 FIX MODE

Set the GPS fix mode.

2D: 2D positioning can be done with height acquired.

3D: 3D positioning can be done with height acquired.

AUTO: 2D positioning and 3D positioning can automatically be selected with optimum.

7.9.2.4 ELEVATE MASK

Limit the satellite to be used with elevation angle.

7.9.2.5 HDOP

Set the HDOP level of the GPS receiver.

The smaller the value, the higher the accuracy although fixing a position becomes difficult.

7.9.2.6 SMOOTHING LL

Smoothing can be applied to measured positions. The higher the smoothing value, the smoother the results will be, but the greater the time lag. Conversely, if the smoothing value is set low, a great number of changes will occur, but there will be little time lag. As such, it is important to choose the optimal value for your own usage situation.

7.9.2.7 SMOOTHING SOG

Smoothing can be applied to measured speeds. The higher the smoothing value, the smoother the results will be, but the greater the time lag. Conversely, if the smoothing value is set low, a great number of changes will occur, but there will be little time lag. As such, it is important to choose the optimal value for your own usage situation.

7.9.2.8 SMOOTHING COG

Smoothing can be applied to measured courses. The higher the smoothing value, the smoother the results will be, but the greater the time lag. Conversely, if the smoothing value is set low, a great number of changes will occur, but there will be little time lag. As such, it is important to choose the optimal value for your own usage situation.

7.9.2.9 SMOOTHING

This setting is corresponding to relatively old JRC GPS model.

Note: The smoothing setting range is as below.

0/10/40 sec

Smoothing function can be applied to measured positions, speeds and courses. However, if the set value of the smoothing is too high, it is possible to obtain a smooth result, but a large time lag is generated at the same time.

Conversely, if the set value of the smoothing is too low, many changes will be generated, but the time lag will be reduced considerably. Thus, it is important to choose an optimal value for your own usage situation.

7.9.2.10 SMOOTHING

This setting is corresponding to relatively new JRC GPS model.

Note: The smoothing setting range is depending on the JRC GPS software version.

0 to 99 sec (R29.04~R33.99)

1 to 99 sec (R26.01~R29.03)

Smoothing function can be applied to measured positions, speeds and courses.

However, if the set value of the smoothing is too high, it is possible to obtain a smooth result, but a large time lag is generated at the same time.

Conversely, if the set value of the smoothing is too low, many changes will be generated, but the time lag will be reduced considerably. Thus, it is important to choose an optimal value for your own usage function.

7.9.2.11 RAIM ACCURACY LEVEL

Set the RAIM accuracy level to be used. RAIM is the function that the receiver judges whether the accuracy of GPS position information meets the conditions or not. The higher the accuracy level is, the wider the judgment range is. When off is selected, RAIM accuracy level function is stopped and the judgment cannot be performed. For single GPS, set to 30m or more.

7.9.2.12 EXCLUSION SATELLITE

It uses the GPS satellites to get position information. But in this setting it sets for a satellite to disable. Please set when the failed GPS satellite was found.

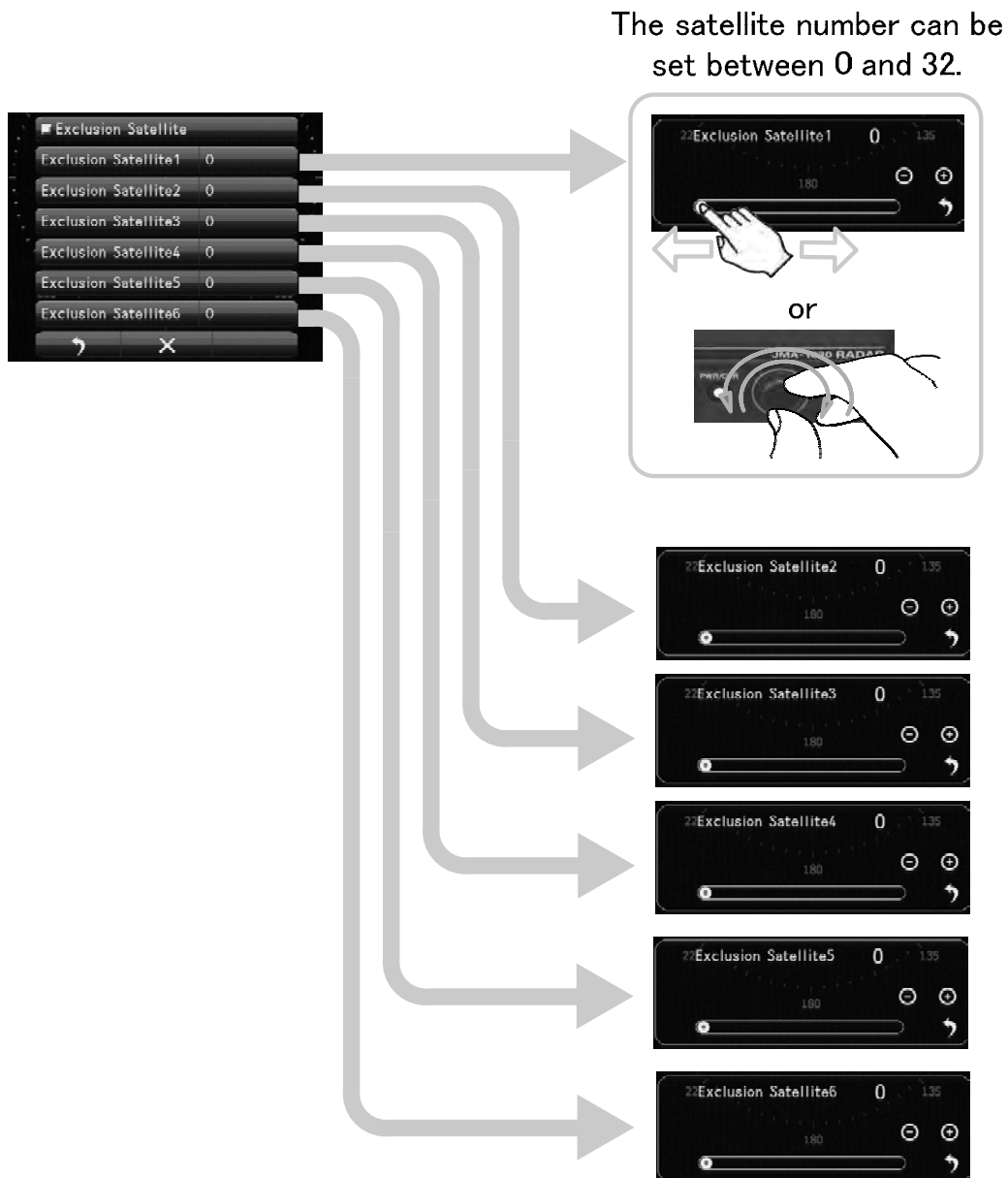

7.9.2.13 GPS SETTING SEND DATA

Send GPS setting Data to the GPS receiver.

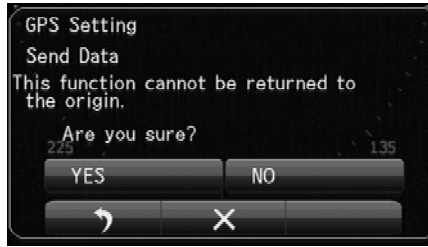

7.9.2.14 GPS ADJUST

Input the approximate latitude and longitude of the own ship to acquire initial.

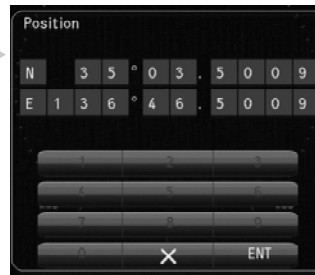

Set the antenna height.



Enter the current time in UTC.

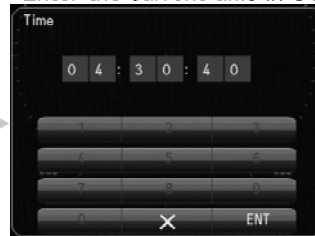

Enter the current date in UTC.

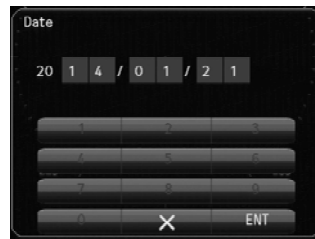

Initialize the GPS receiver.

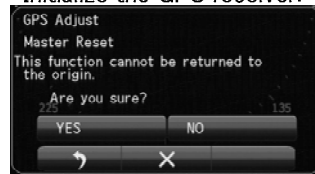

Send to configured data to the GPS receiver.

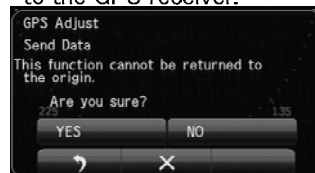

7.9.3 BEACON SETTING

Set for a JRC Beacon (DGPS receiver). This setting is available only for JRC Beacon receiver (DGPS receiver).

*AUTO: Select an optimum beacon station automatically.

Manual: You need to set the beacon frequency and baud rate by yourself.

Note: This setting is enabled when “Station Select” is set to “Manual”.

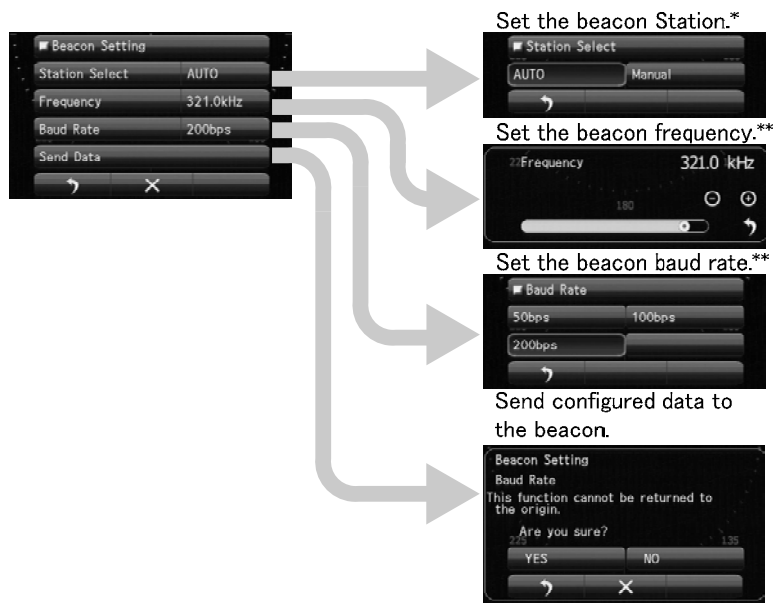

7.9.4 SBAS SETTING

*AUTO: Automatically selects the SBAS satellite number.

Manual: Manually enter the SBAS satellite number.

** This setting is enabled when “Satellite Search” is set to “Manual”.

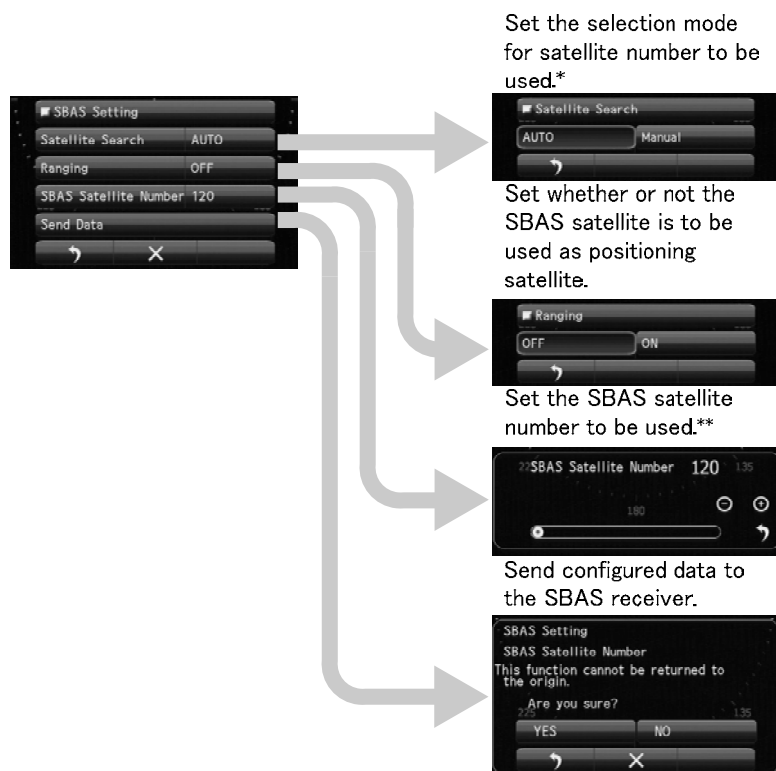

Chapter 8 DETAIL PERFORMANCE SETTINGS

8.1 SETS RADAR ECHO

This setting, are items that greatly affects the radar image. When you want to change, please change while observing the radar image carefully.

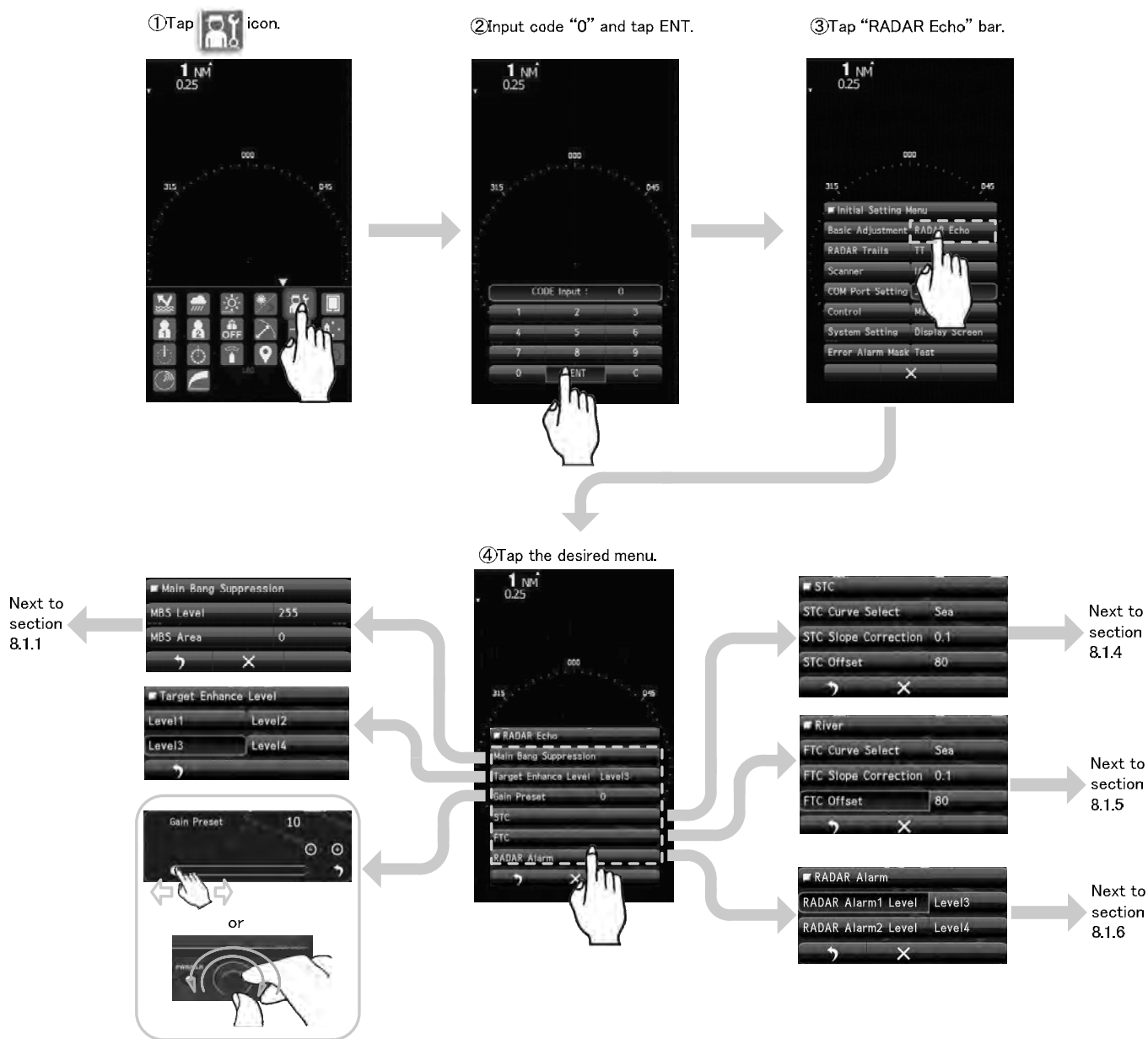

8.1.1 MAIN BANG SUPPRESSION

Main Bang Suppression is adjusted to suppress main bang, a reflection signal from 3D circuit including wave guide tube, that generally appears as a circular image focusing on the center of the radar display.

Optimum adjustment allows main bang image to remain lightly on the display.

If the main bang is not so big, use the default setting at factory.

Before adjustment:

1. Set the range to 0.125NM.
2. Set the radar video enhance function.
3. Set the radar video process function.
4. Turn the [GAIN] control to the maximum position.
5. Turn the [RAIN] control to the minimum position.
6. Turn the [SEA] control to achieve the strength with which main bang can be judged.



WARNING



Do not change suppression level/area unless absolutely necessary. Incorrect adjustment will result in deletion of nearby target images and thus collisions may occur resulting in accidents.

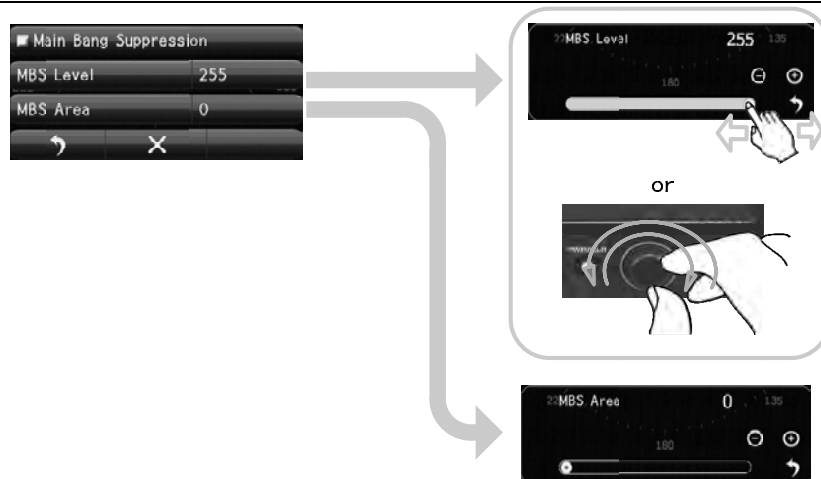

8.1.2 TARGET ENHANCE LEVEL

Sets the level of target enhancement.

Target enhance level can be set from level1 to level4. If the level is set too high, the range resolution may be declined. So it is necessary to set a value properly.

8.1.3 GAIN PRESET

Adjust the minimum sensitivity level of the [GAIN] control.

Do not change this adjusted level carelessly

The value is usually set to 0 and should not be changed unless there is problem.

Before performing this adjustment, perform the operation described in "NOISE LEVEL ADJUSTMENT".



CAUTION



If sensitivity is set too high, unnecessary signals such as noises in the receiver and false echoes increase to lower target visibility. At the same time, if sensitivity is set too low, detection of targets such as ships and dangerous objects may be hindered. Therefore, sensitivity must always be set to an optimal level.

8.1.4 STC

Sets the STC Curve. User selects the "river" or "sea" of the curve selection. Please do not change the STC offset and slope correction. If the value changed, affects sea clutter suppression function drastically.

⚠ CAUTION

When using the sea clutter suppression function, never set the suppression level too high canceling out all image noises from the sea surface at close range. Detection of not only echoes from waves but also targets such as other ships or dangerous objects will become inhibited. When using the sea clutter suppression function, make sure to choose the most appropriate image noise suppression level.

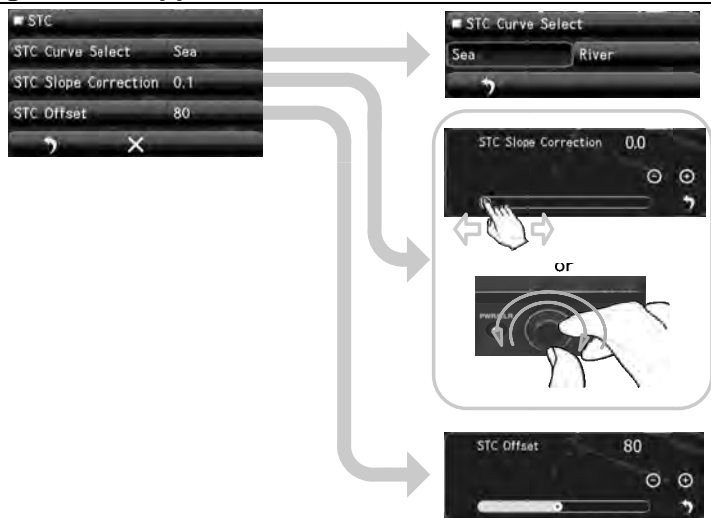

8.1.5 FTC

Sets the FTC Curve. User selects the "river" or "sea" of the curve selection. Please do not change the FTC offset and slope correction. If the value changed, affects rain clutter suppression function drastically.

⚠ CAUTION

When using the rain clutter suppression function, never set the suppression level too high canceling out all image noises from the sea surface at close range. Detection of not only echoes from waves but also targets such as other ships or dangerous objects will become inhibited. When using the sea clutter suppression function, make sure to choose the most appropriate image noise suppression level.

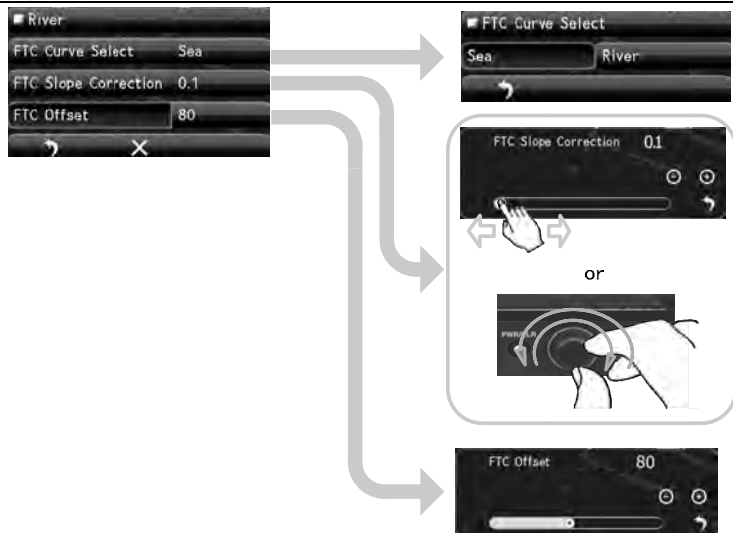

8.1.6 RADAR ALARM LEVEL

This display unit has guard zone function (area specified by the distance from own ship) (refer to 5.4). It is not able to specify the region by latitude and longitude. Radar alarm level means alarm detection level in the guard zone.

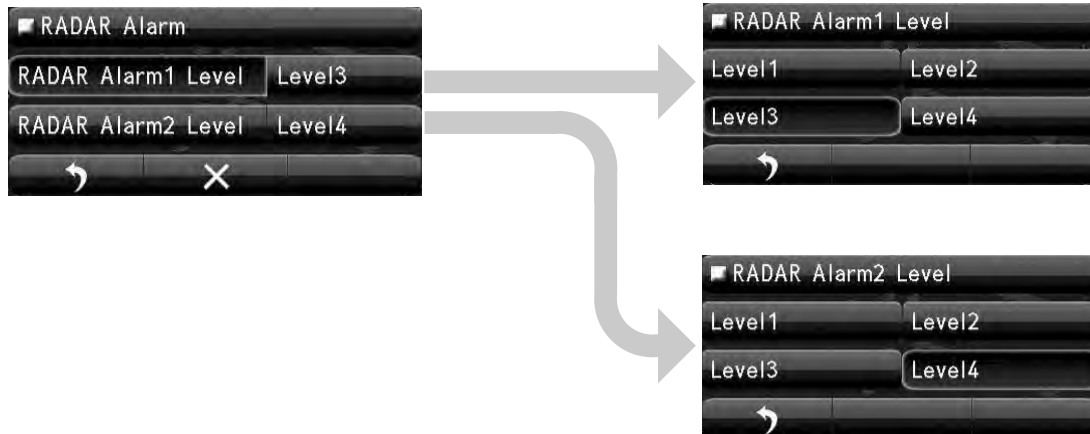

When ships enter or depart from the guard zone, alarm will sound.

Detection levels can be set from level1 to level4.

When setting to lower level detection, the alarm operates for weaker targets.

When setting to higher level detection, be careful because the alarm may not operate properly.

RADAR Alarm1: For guard zone1.

RADAR Alarm2: For guard zone2.

8.2 TT FUNCTION

CAUTION

Do not change the quantization level settings unless absolutely necessary. If set at an inappropriate value, the acquisition or tracking function of the target tracking function (TT) deteriorates, and this may lead to accidents.

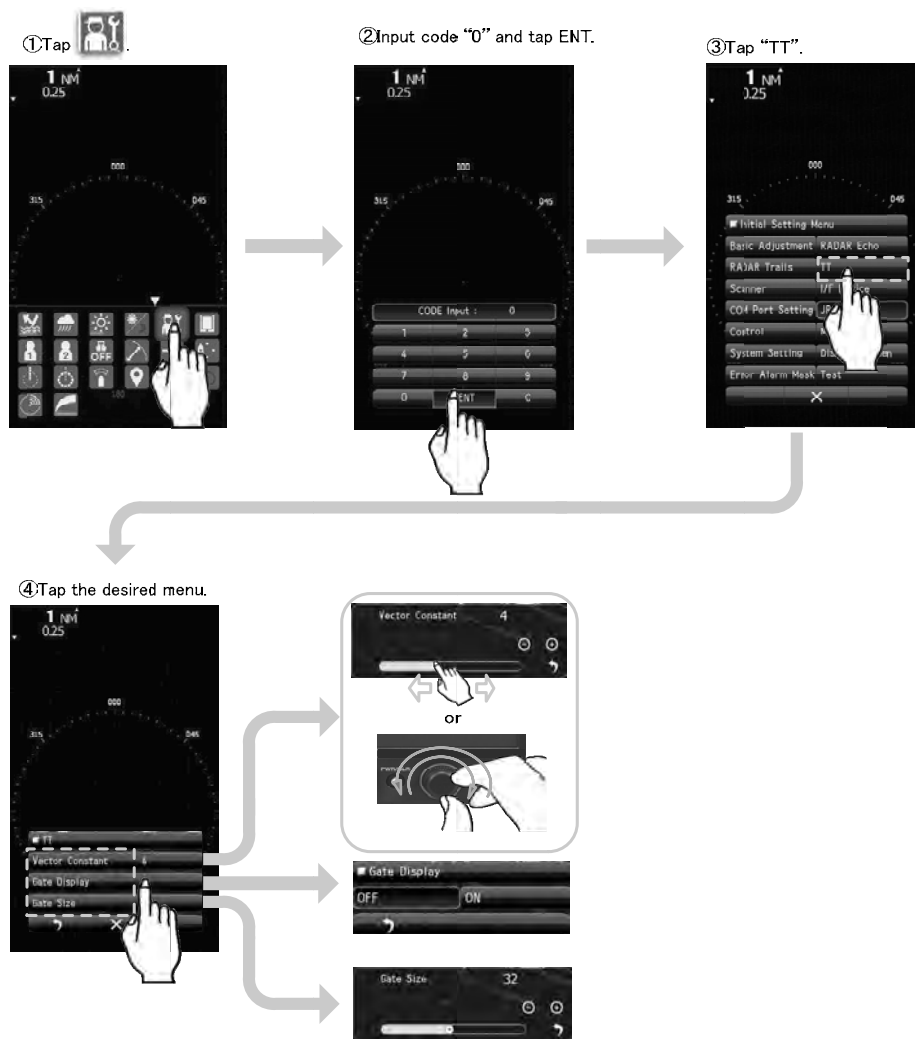

Vector Constant: Vector shows the movement of the target. When Vector Constant is large, vector is stable, but the response is slow. When Vector Constant is small, vector is unstable, but the response is quick.

Gate Size: Set up the region size which can search the movement target automatically. When region is wide, possible to track fast moving target, but many clutters are include. Sometime do miss tracking because of much noise. When region is narrow, possible to track stable, but fast moving targets are tend to lost. Because of fast target soon goes outside of the region.

Gate Display: Set the display on/off of target detection area (gate) for target trail function.

Note:

The TT function requires own ship's heading and GPS signal (COG/SOG) information. If there are not these information, TT function does not function correctly.

8.3 SCANNER FUNCTION

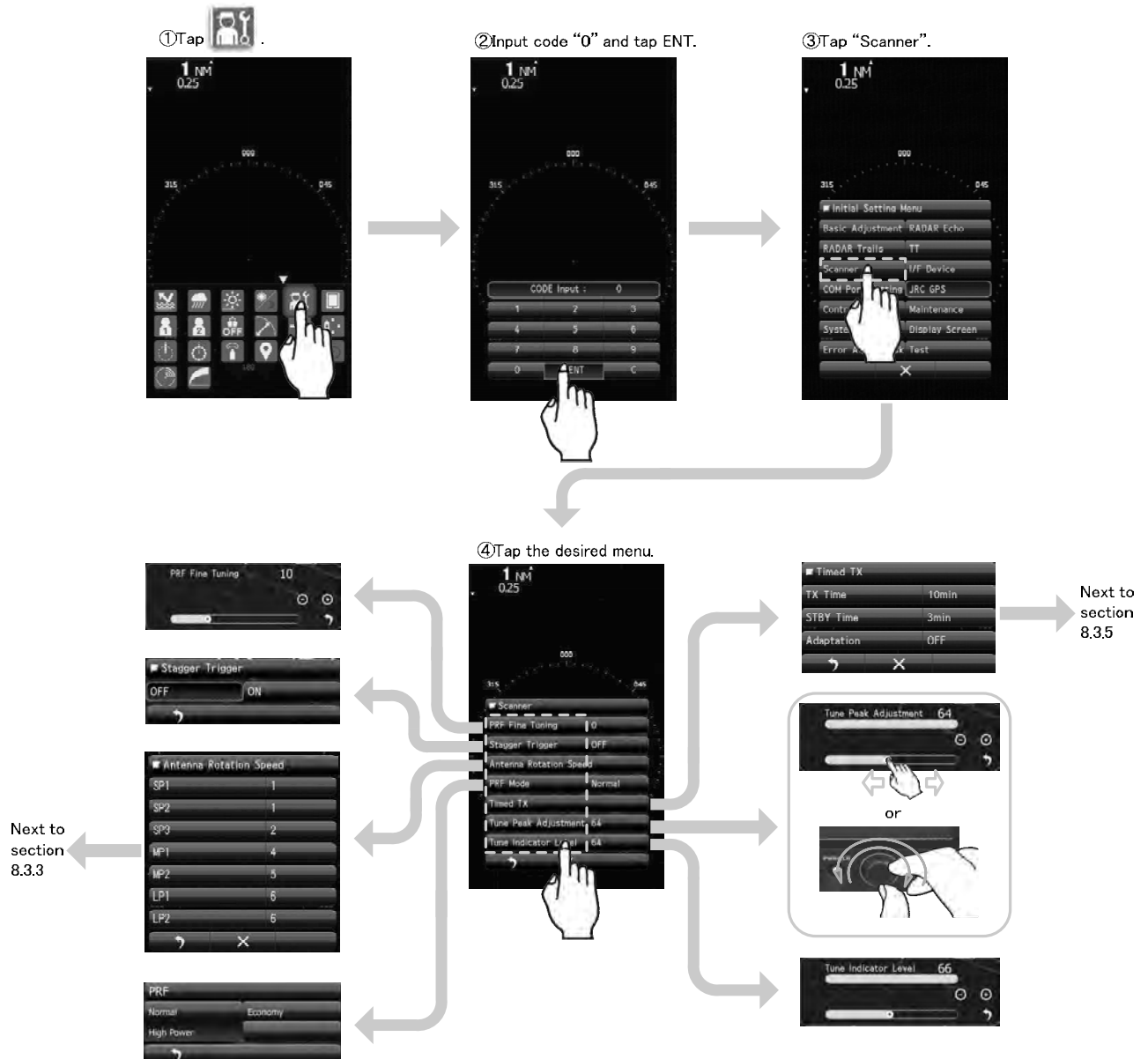

8.3.1 PULSE REPETITION FREQUENCY FINE TUNING (PRF FINE TUNING)

If radar's interference patterns are concentrically displayed, increment or decrement the set value by 3 to 4 in order to heighten the effect of interference rejection.

PRF Fine Tuning:

Fine-tune the transmitting repetition frequency of the transmitter in the range 90% to 100%. This setting cannot be performed simultaneously with the setting of "STAGGER TRIGGER".

8.3.2 STAGGER TRIGGER

Turn on/off the interference reduction function controlled by the transmission repetition frequency control of the transmitter.

This function is effective when radar interference does not go away.

This setting cannot be performed simultaneously with the setting of "PRF FINE TUNING".

8.3.3 ANTENNA ROTATION SPEED

Set the scanner rotation speed for each pulse length. The radar sensitivity is higher when antenna is rotating in low speed. Short range operation requires a high speed antenna rotation to refresh the screen as soon as possible. Long range operation requires a low speed antenna rotation to maintain a high sensitivity. You can select a rotational speed according to your request.

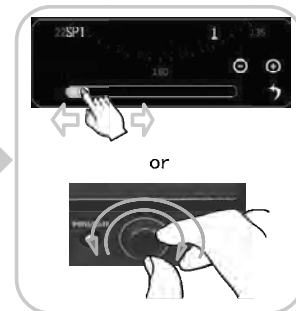

0=48rpm, 1=42rpm, 2=36rpm, 3=30rpm,
4=27rpm, 5=24rpm, 6=20rpm, 7=16rpm

8.3.4 PRF MODE

Select the operation mode of the transmitting repetition frequency of the transmitter.

Normal: Default setting is Normal. Both appropriate sensitivity and magnetron life expectancy are considered.

Economy: Sensitivity slightly lowers, but the service life of magnetron is prolonged when short pulses are used.

High Power: Sensitivity improves when long pulse are used, but the service life of magnetron is slightly shortened.

8.3.5 TIMED TX



CAUTION



Don't use the timed TX function unless absolutely necessary. At the STBY time area, radar echo disappear in the antenna rotating. If you forget to execute the timed TX, and this may lead to accidents.

Timed TX is function that radar repeat transmitting and not transmitting by each set time minutes. But is of course, the radar echo disappear during the not transmitting. As a result timed TX can save magnetron life longer. To enable the timed TX function, you need to set ON Timed TX in main menu (5.12.7) after you set ON of Adaptation in this menu.

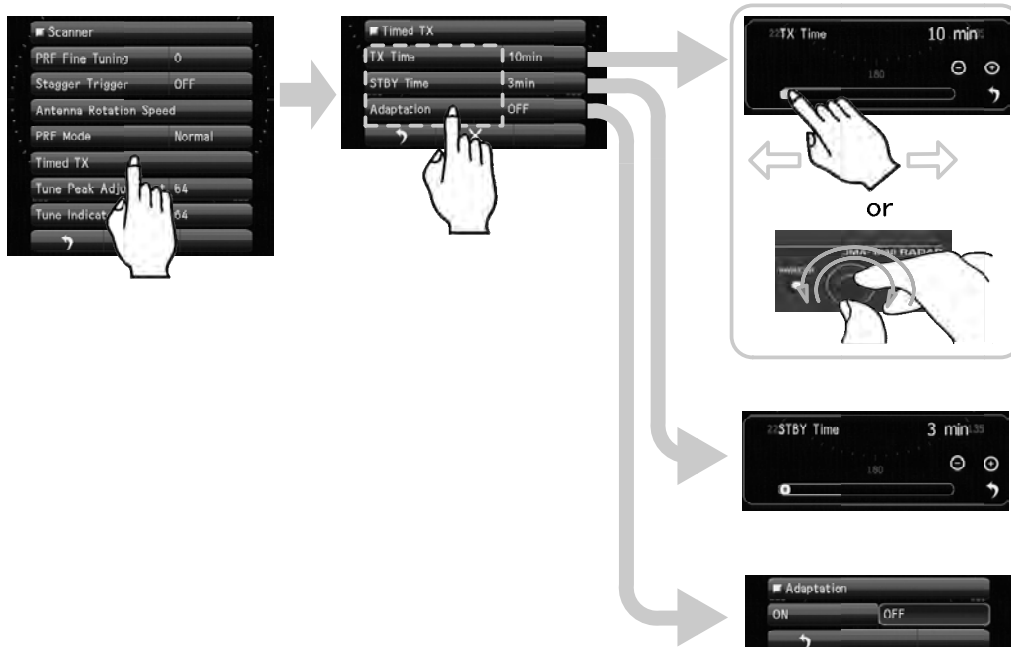

8.3.6 TUNE PEAK ADJUSTMENT

CAUTION



Don't adjust the tune peak adjustment value unless the serviceman. This value is already setting in the factory. If change this value in unnecessary, Auto Tune function will be influenced, and radar echo will become weak at Auto Tune, and this may lead to accidents.

Please make adjustments tuning indicator bar to be swing largest at the tuning position of the maximum sensitivity. This adjustment must be done with (8.3.7 Tuning indicator) alternately.
Set the range to 24NM (JMA-1032) or 48NM (JMA-1034).

Note:

Always to be set the tune-peak-adjustment value of near the 64 at the factory.

When the equipment is used for a long time and automatic tuning function no longer works properly, adjusting the tune peak adjustment value may result in improvement of the automatic tuning function.

It should be noted that an optimal adjustment value is required for proper operation of the automatic tuning function.

8.3.7 TUNE INDICATOR LEVEL

CAUTION



Don't adjust the tune indicator level value to 100% tune bar. This value is already setting in the factory. If change this value in unnecessary, Auto Tune function will be influenced, and radar echo will become weak at Auto Tune, and this may lead to accidents.

If the tuning level is too low, then you need to adjust the tune indicator level.
Set the range to 24NM (JMA-1032) or 48NM (JMA-1034)

Note:

Do not let the tune indicator bar reach 100% while adjusting the tune level.

The automatic tuning function may not perform properly if the bar reaches 100%.

Set the level such that the tune indicator bar always reads 80% to 90%.

8.4 CONTROL

You can adjust the buzzer volume and calibration of the touch panel.

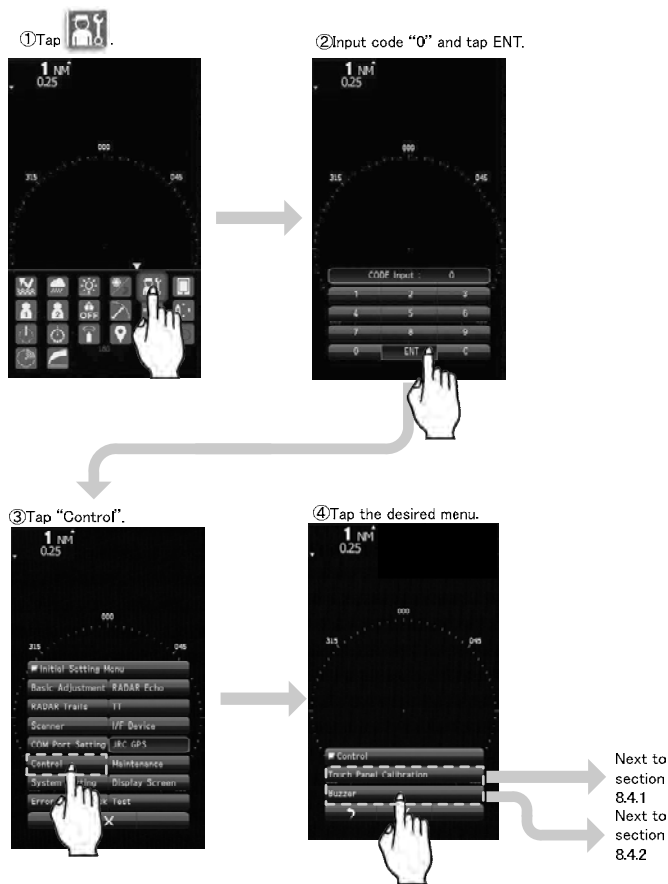

8.4.1 TOUCH PANEL CALIBRATION

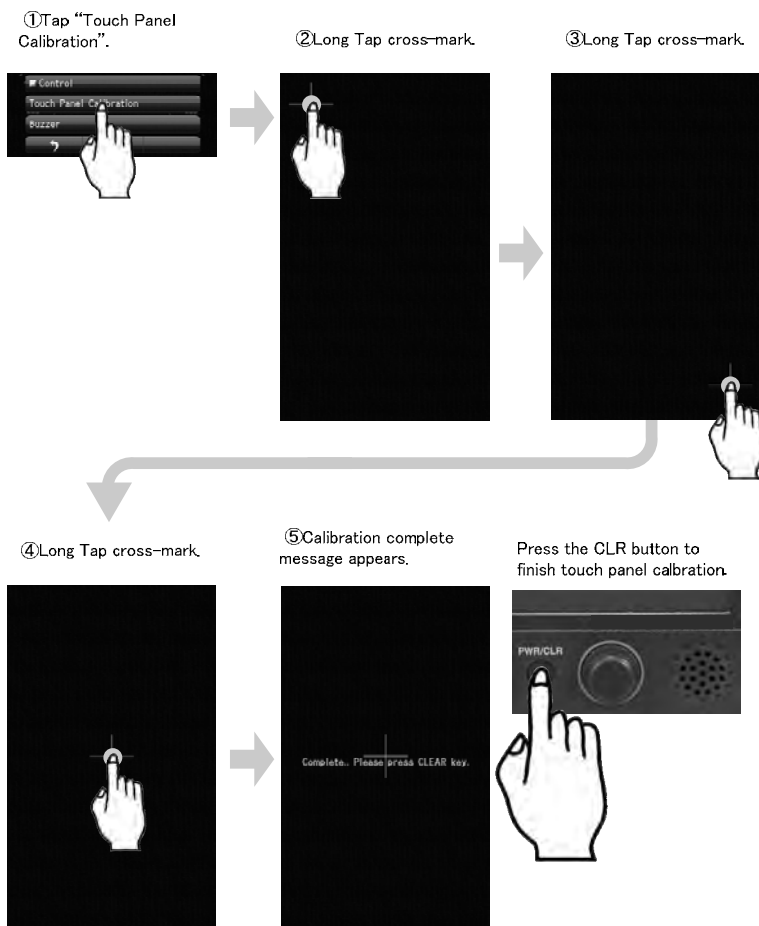

Please run this menu if there is a difference in the position it reacts with the position touched on the screen.

And, please also used this menu when you have changed the touch pen, etc..

8.4.2 BUZZER

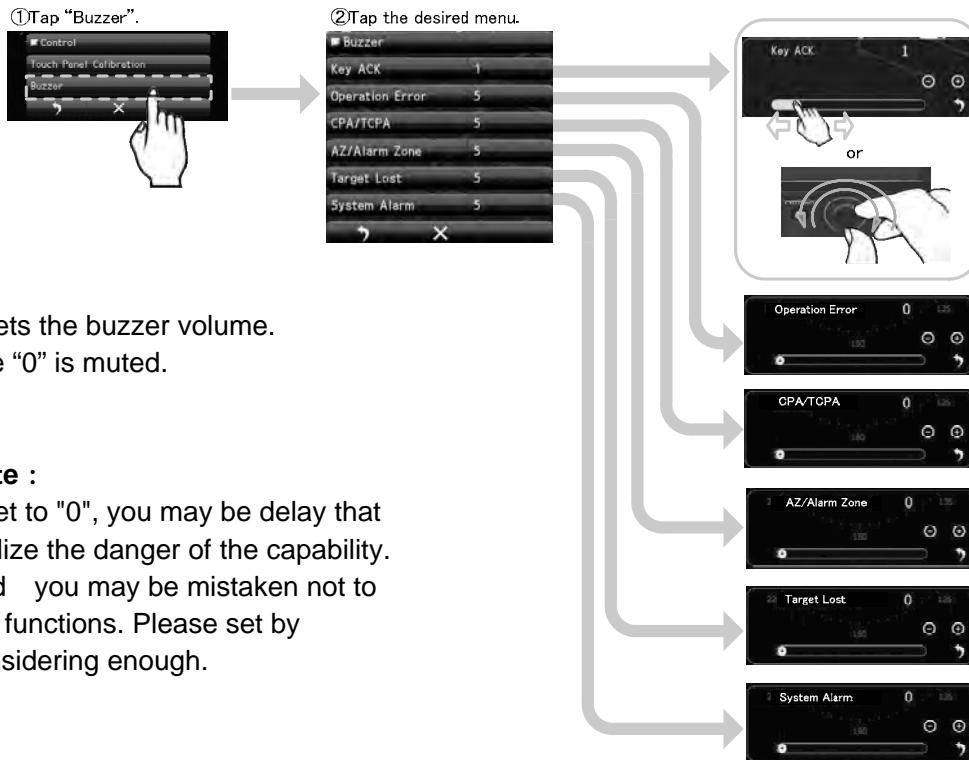

8.5 MAINTENANCE SETTING

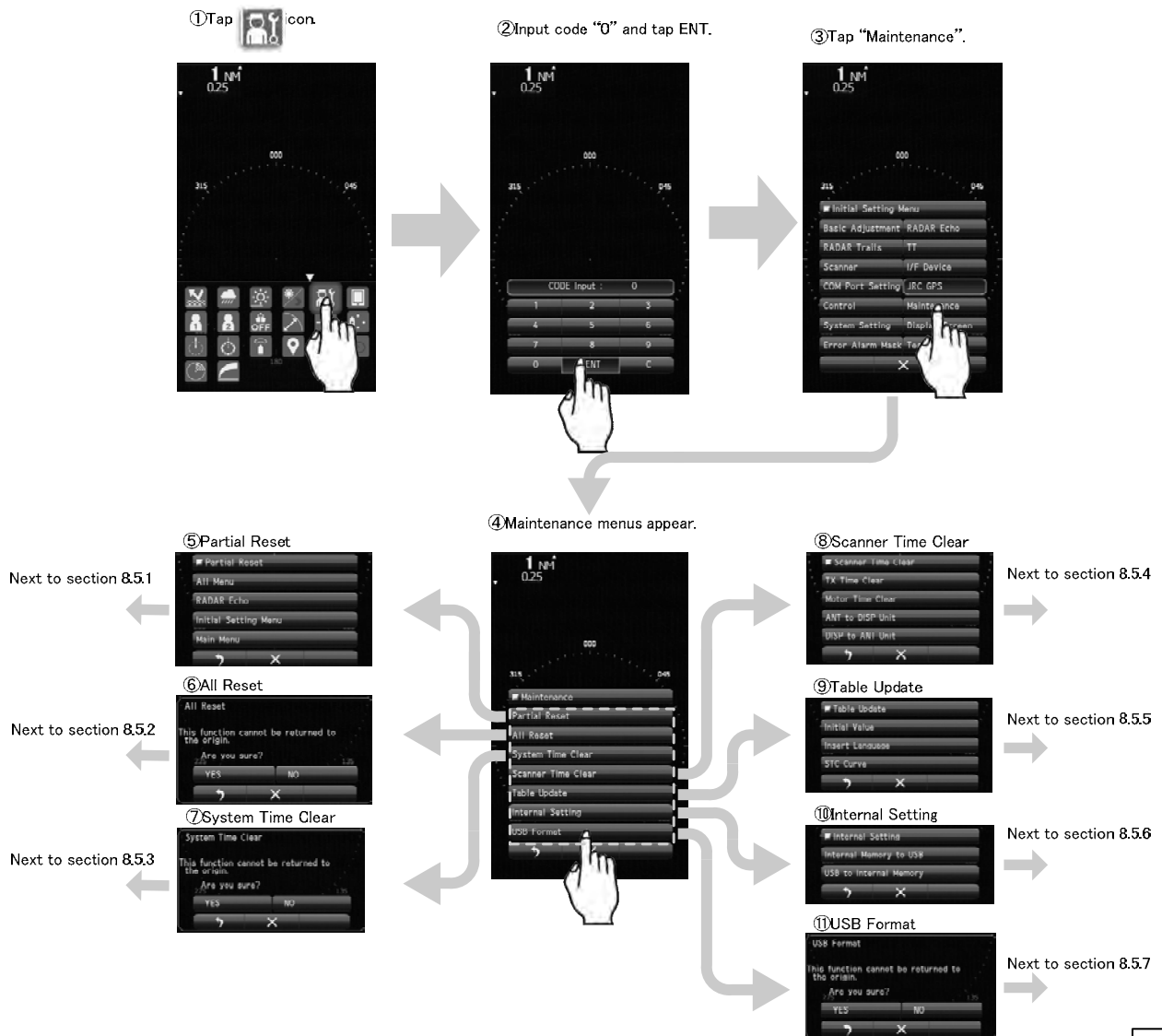

8.5.1 PARTIAL RESET

CAUTION

If you press YES, the operation will be executed immediately.

The partial reset is the function to read out table update value (see 8.5.5).

Reference:

Initialization function of the partial reset is the function to read out table update value (see 8.5.5).

Items which can be reset.

All Menu: Initialize all settings (except marks, lines).

RADAR Echo: Initialize the RADAR Echo settings in the Main Menu and the Initial Setting Menu.

Initial Setting Menu: Initialize the Basic adjustment settings and the Function Settings.

Main Menu: Initialize the settings of the Main Menu and radar screen settings (except RADAR Echo and Function Setting).

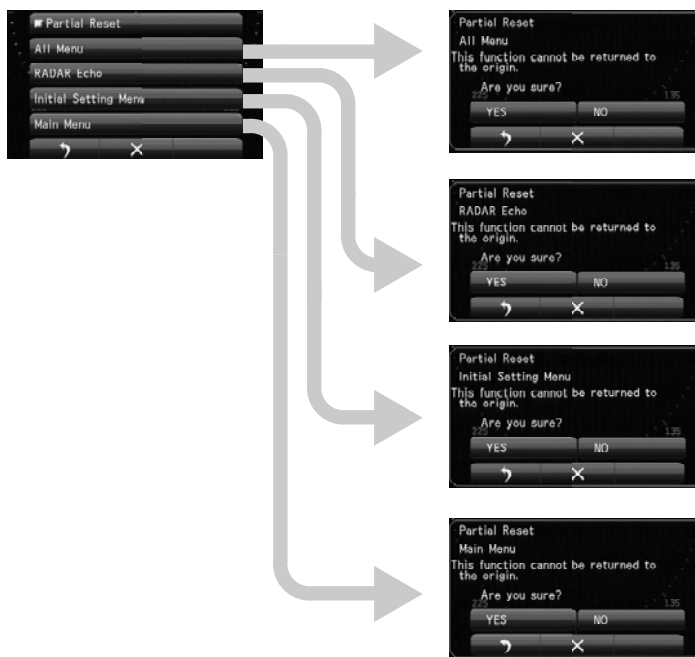

8.5.2 ALL RESET

If system operation is unstable, it may be stabilized by initialized the memory area. To initialize the memory area, the all settings become to the factory inspection settings. It is recommended that you save to USB storage internal settings before to run the all reset. (see 8.5.6.1)

CAUTION

If you press YES, the operation will be executed immediately.

Note that performing “All Reset” erases data, such as marks/lines.

“All Reset” make to initialize the memory area, the all settings become to the factory inspection settings.

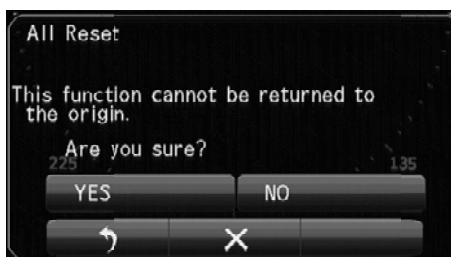

8.5.3 SYSTEM TIME CLEAR



CAUTION



If you press YES, the operation will be executed immediately.

The operating time of the display unit can be initialized.

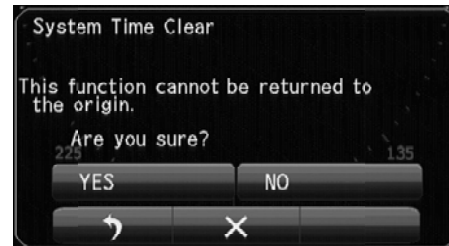

8.5.4 SCANNER TIME CLEAR

Initialize the transmit time when magnetron is replaced.

Initialize the transmit time when motor is replaced.

Initialize the Scanner Running time.

Initialize the Transmit time.

Save the following scanner time data stored in the scanner into the display unit.

- Scanner Transmit Time
- Motor Rotating Time

When replacing the scanner internal control circuit, perform the procedure below to inherit scanner time data.

1. Save the scanner time data.
2. Replace the scanner internal control circuit.
3. Restore the scanner time data.

Restore the scanner time data stored in the display unit into the scanner internal control circuit.

Initialize those operating time above when magnetron or scanner motor is replaced.

8.5.5 TABLE UPDATE



CAUTION



The following data can be uploaded.

- Initial Value
- STC Curve
- Insert Language

It is recommended that, when you installed the radar and the radar adjustment has been completed, run the table update by selecting of the all menu in initial value of this item. It becomes possible to restore the settings at the time of the update table by the partial reset function (see 8.5.1).

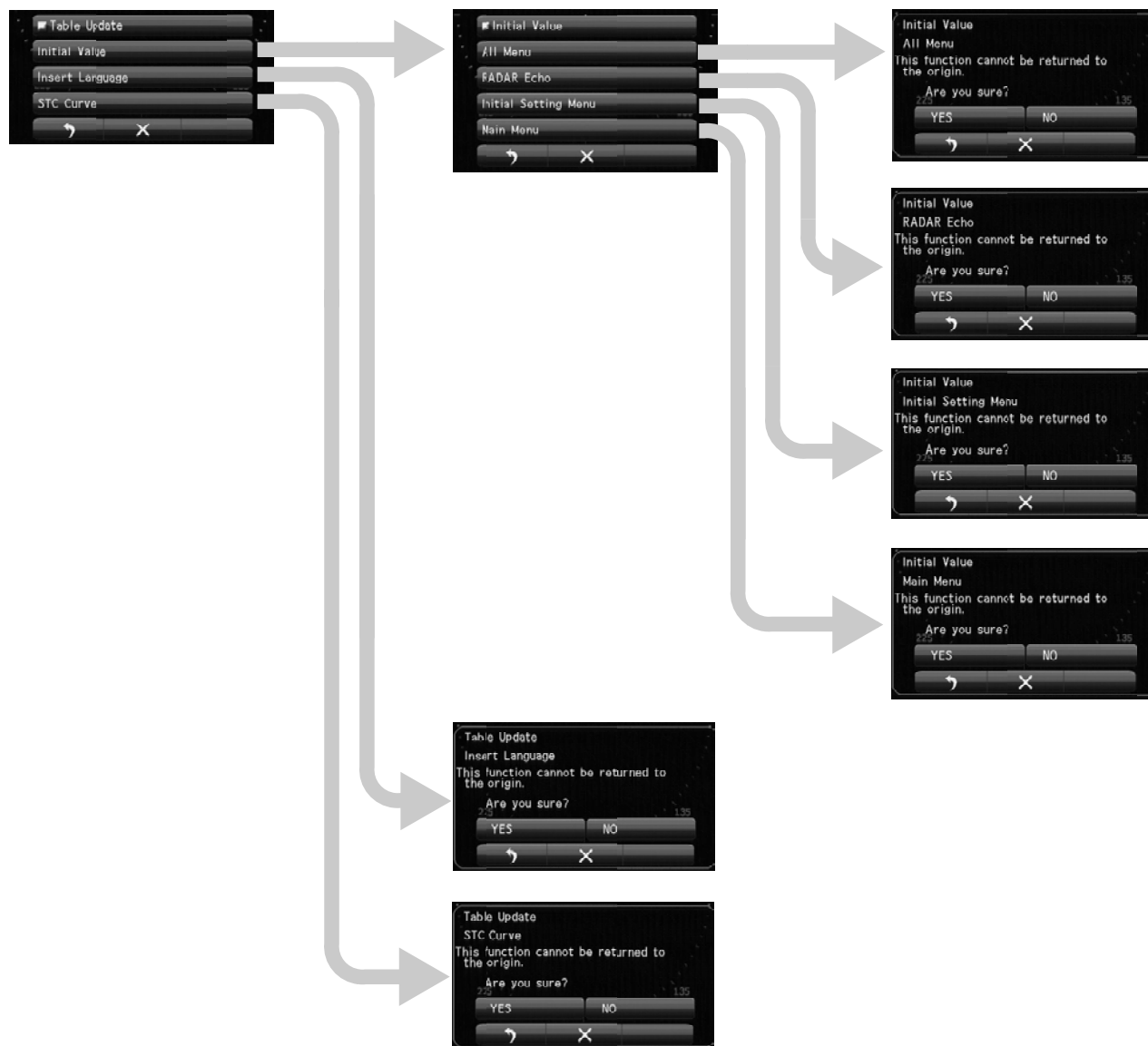



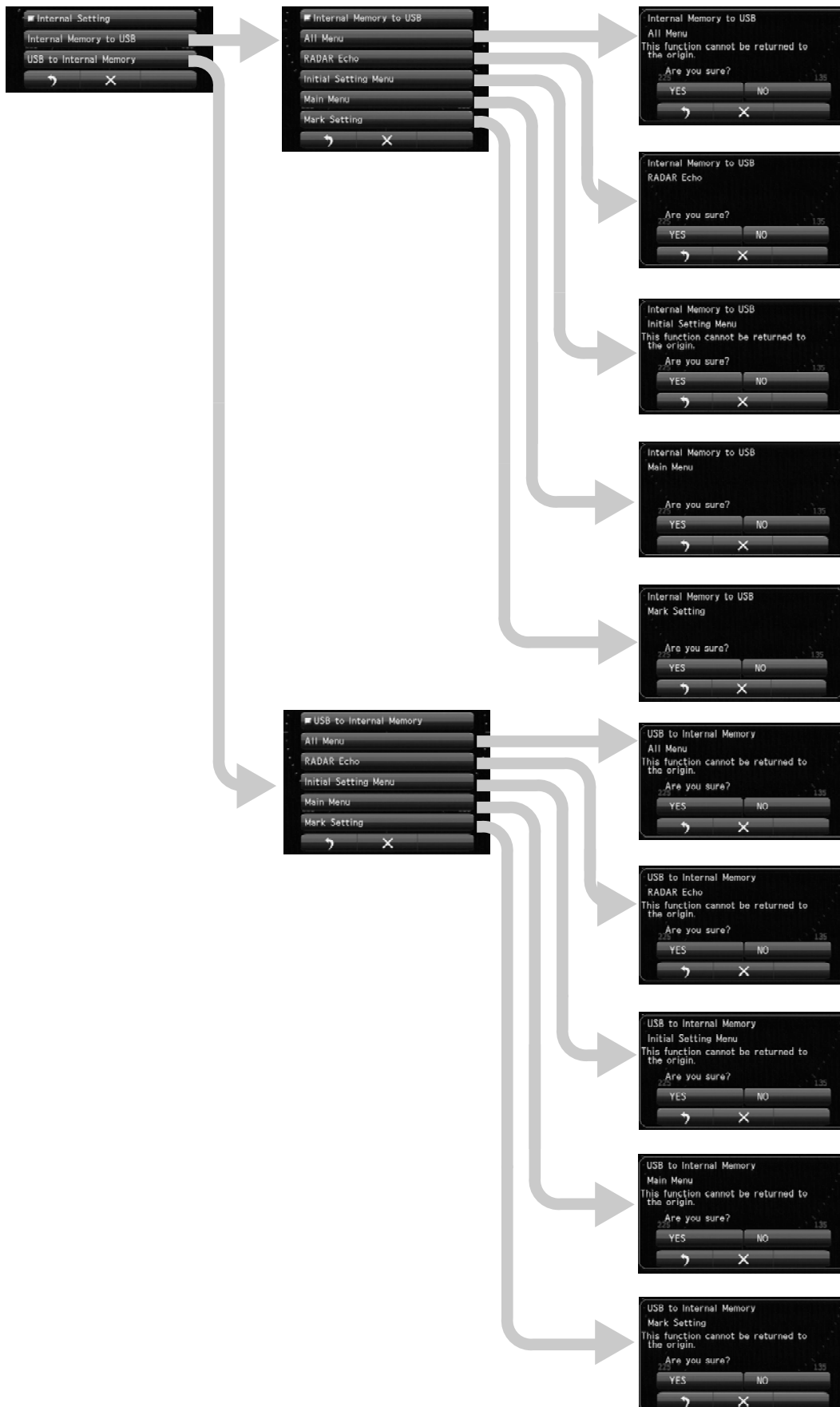

8.5.6 INTERNAL SETTING

You can store in the internal settings to the USB memory by using the USB port or read out the internal settings from USB memory.



8.5.6.1 INTERNAL MEMORY TO USB

 CAUTION	
	<p>If the USB memory is not recognized by causes such as compatibility, please try the following items.</p> <ul style="list-style-type: none"> • Format the USB flash memory in FAT32 format. • If it has been formatted in FAT32 format already, delete all files in USB flash memory.
	<p>You cannot use a USB flash memory built the following functions.</p> <ul style="list-style-type: none"> • Encrypting contents. • Checking virus infection.
	<p>It may take long time to access USB flash memory during transmission. We recommend that you use USB flash memory during stand-by.</p>

Note:

When the USB flash memory is inserted, the dedicated folder to save / read the internal value will be created. However, as the capacity of the USB flash memory is large, it takes time to create the dedicated folder.

USB flash memory	Format type	Dedicated folder creation time
1GB	FAT32	70sec
8GB	FAT32	500sec

*Reference time

The following is a method for reducing the dedicated folder creation time using the PC.

- 1.Format the USB flash memory in FAT32 format.
- 2.Open the properties of the USB flash memory formatted.

You can copy the system settings which were saved in the internal memory (such as various item settings of menus, etc.) to a USB flash memory. To copy the settings which were saved in the internal memory, a USB flash memory must be inserted into "USB MEMORY" port on the control panel beforehand. When you replaced the processing circuit inside the display unit, you can restore the system by load the data stored in the USB flash memory and write it to the system memory.

It should be saved to USB flash memory when the system settings are completed. And we strongly recommend that you save the operating conditions to a USB flash memory on a regular basis.





Items which can be saved to a USB flash memory are following.

- All Menu: Internal all settings will be saved to the USB.
- RADAR Echo: RADAR Echo settings in the Main Menu and the Initial Setting Menu will be saved to the USB.
- Initial Setting Menu: Initial Setting Menu will be saved to the USB
- Main Menu: Main Menu settings will be saved to the USB.
- Mark Setting: Mark, Line and Memo Settings will be saved to the USB.

8.5.6.2 USB TO INTERNAL MEMORY

Load the data stored in the USB flash memory and write it to the system internal memory. Through this operation, you can return the system to the previous operation condition after replaced the processing circuit.

8.5.7 USB FORMAT

 CAUTION	
	<p>If the USB memory is not recognized by causes such as compatibility, please try the following items.</p> <ul style="list-style-type: none"> • Format the USB flash memory in FAT32 format. • If it has been formatted in FAT32 format already, delete all files in USB flash memory.
	<p>You cannot use a USB flash memory built the following functions.</p> <ul style="list-style-type: none"> • Encrypting contents. • Checking virus infection.
	<p>It may take long time to access USB flash memory during transmission. We recommend that you use USB flash memory during standby.</p>
	<ul style="list-style-type: none"> • During formatting, please do not disconnect the USB flash memory. • Quick format does not support.

Inset USB flash memory to USB port.

If you want to format the USB flash memory, please select "YES".

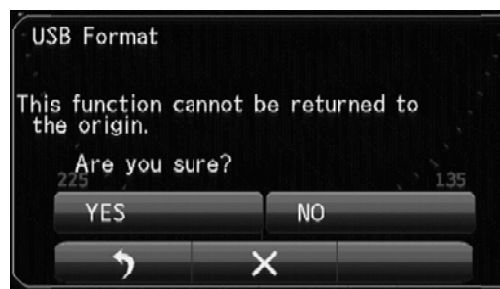

During formatting, the message "In formatting USB" is displayed. Formatting is complete, the message "USB Format Finish" is displayed.

Note:

It takes time to format the USB flash memory. Format time is very similar to the time you want to format the PC. Please follow the instructions of 8.5.6.1 If you can use a personal computer.

8.6 SYSTEM SETTING

It not only sets the system to boot but it sets also the displayed units and own ship outline, the radar range to be used.

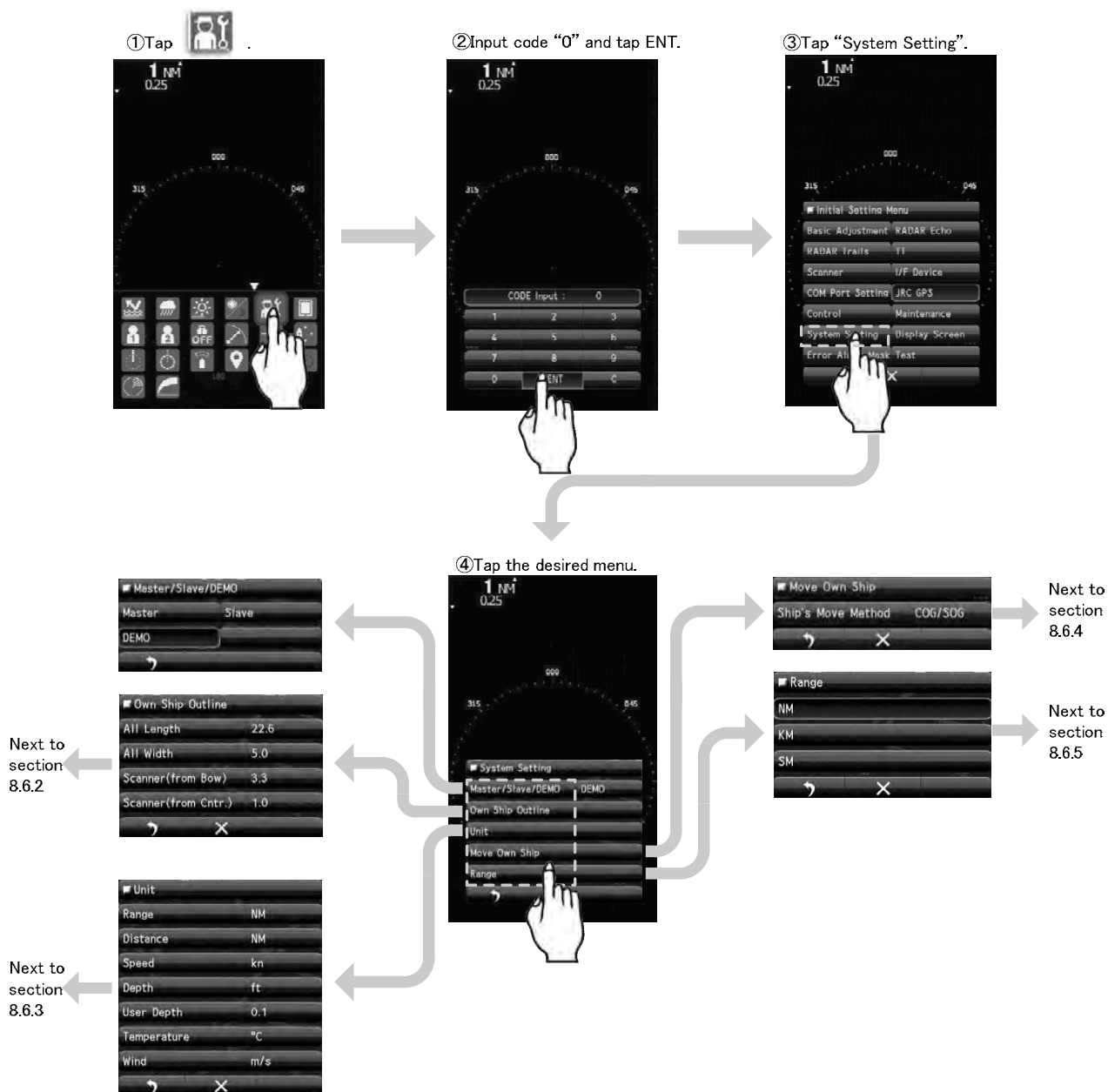

8.6.1 MASTER/SLAVE/DEMO

Master: Set to this item when connecting to scanner.

Slave: Set to this item when input video signal of external source to display echo without scanner.

Demo: Set to this item when no video signal is input from external source and no scanner is connected.

8.6.2 OWN SHIP OUTLINE

You can set the outline of the own ship in meters. In order to reduce the distance measurement error due to radar, please also set the installation position of the scanner.

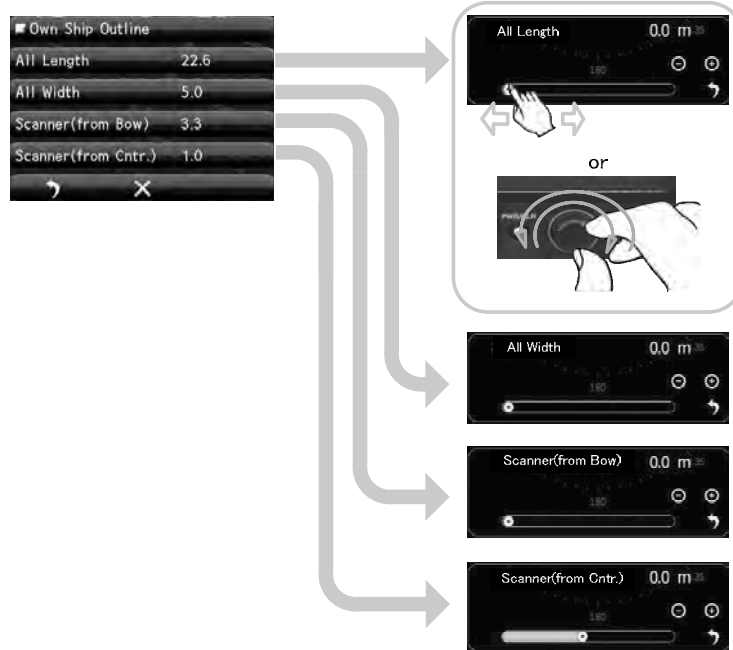

8.6.3 UNIT

Set the unit that you have accustomed.

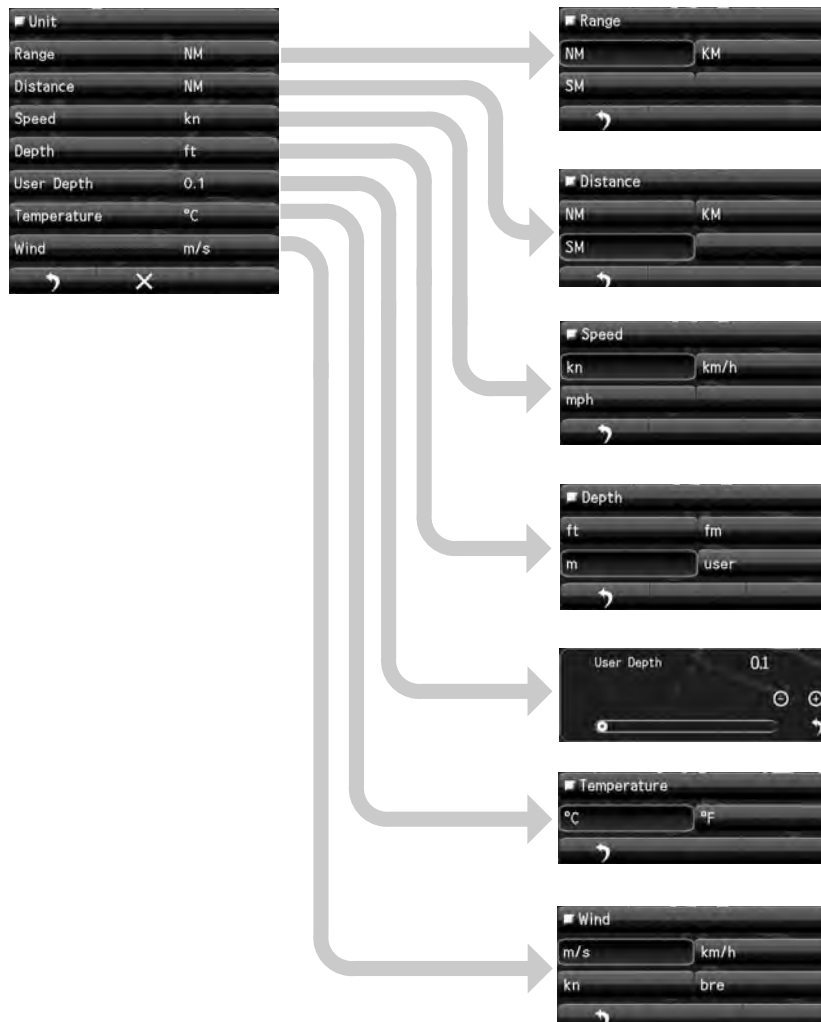

8.6.4 MOVE OWN SHIP

It sets the used signal to a reference of how to move the ship. LL (latitude and longitude) is initial value. There is no need to change it if you have a stable operation of the radar.

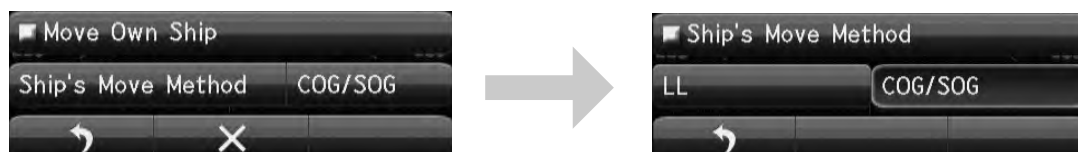

8.6.5 USE RANGE SELECT

Turn on/off the range display.

32NM, 48NM, 32sm and 48sm ranges cannot be used in JMA-1032.

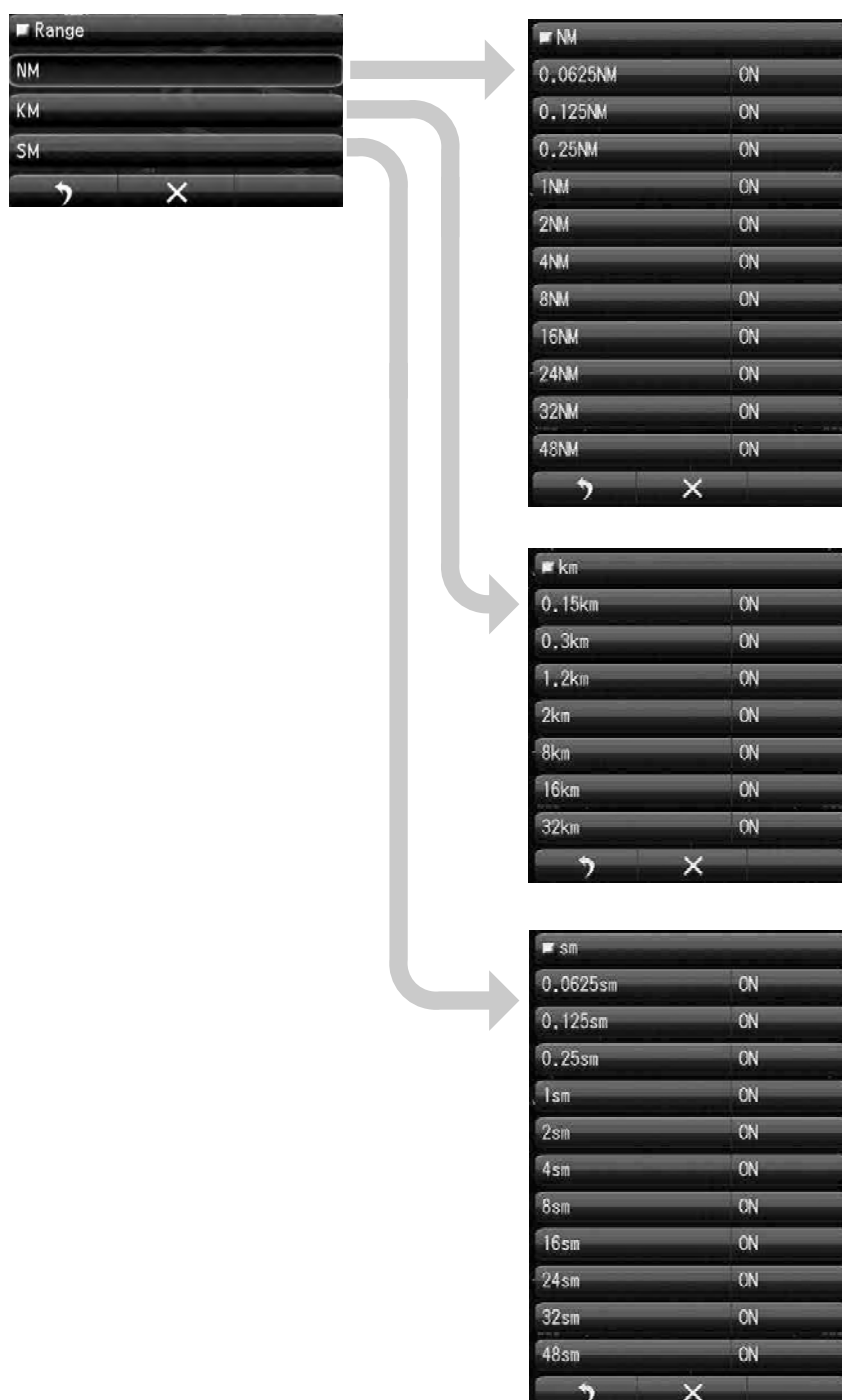

8.7 DISPLAY SCREEN

You can set the display screen color.

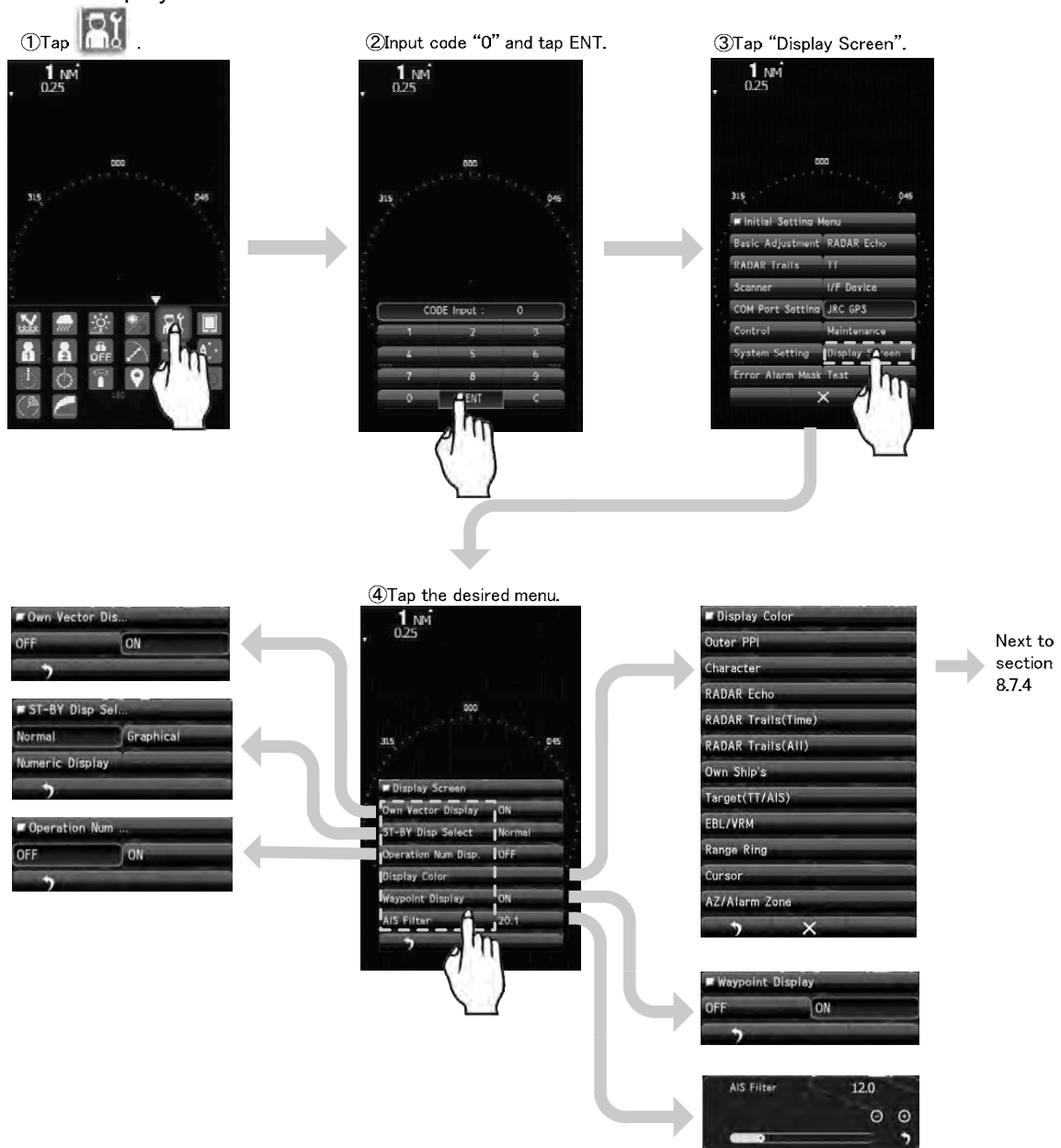

8.7.1 OWN VECTOR DISPLAY

Select the Own Vector display ON or OFF.

Own vector will appear with dotted line. The color is same as the heading line.

To view the Own vector, must be set to True in the vector mode menu.

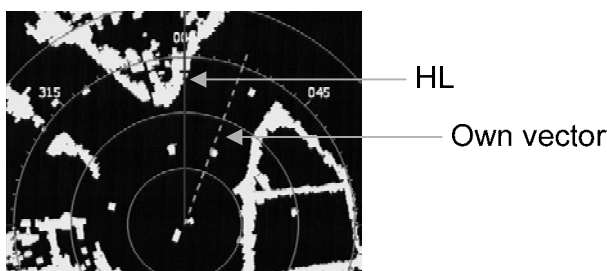

8.7.2 STANDBY DISPLAY SELECT

Switching the display screen in stand-by state. You can also select to flick from side to side on the screen.



Normal

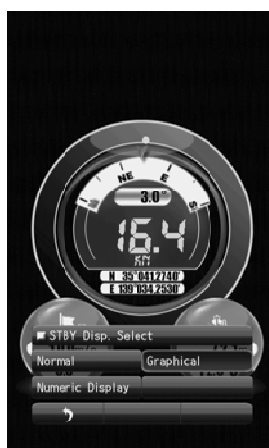

Graphical

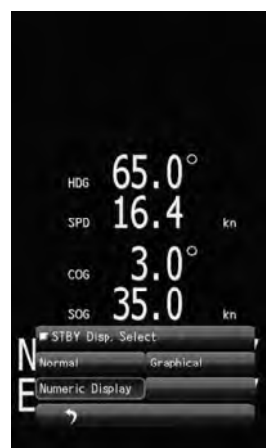

Numerical

8.7.3 OPERATION NUMERICAL DISPLAY

Turn on/off numerical information upper-right on the screen.

Operation Numerical Display "ON"



Operation Numerical Display "OFF"



8.7.4 DISPLAY COLOR

① Tap the desired menu.



② Select "Color" and "Brilliance".

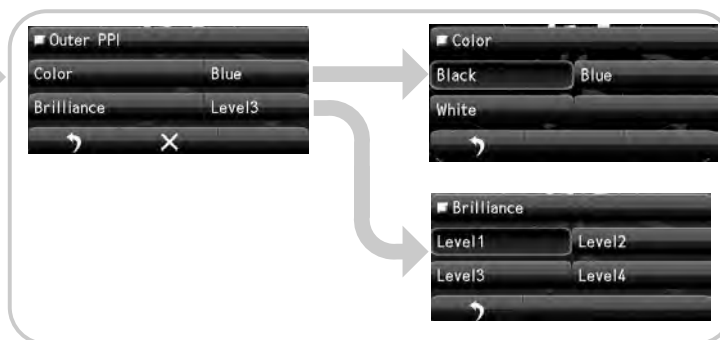

There is that you can not select the color combination. For example, PPI color is black and Character color is black. If you want to select PPI color white, don't forget change the Cursor color except white.

8.7.5 WAYPOINT DISPLAY

When waypoint information is received from the navigation equipment, the waypoint mark appears on the radar.

8.7.6 AIS FILTER

Once the AIS filter is set, only the AIS targets that are inside the filter area are displayed (setting can be made such that AIS targets outside the AIS filter will not be shown).

The filter is initially set in a circle having a radius of 20[NM] from the own ship's position.

If 50 or more targets exist in the filter range, they are displayed according to the priority explained in "AIS Symbols".

8.8 ERROR ALARM MASK

It is possible that even if an error is detected, the error make not to display on the screen.

Do not change the set value carelessly. If alarm detection is turned off or detection time is changed, be careful because the alarm may not occur or may be delayed.

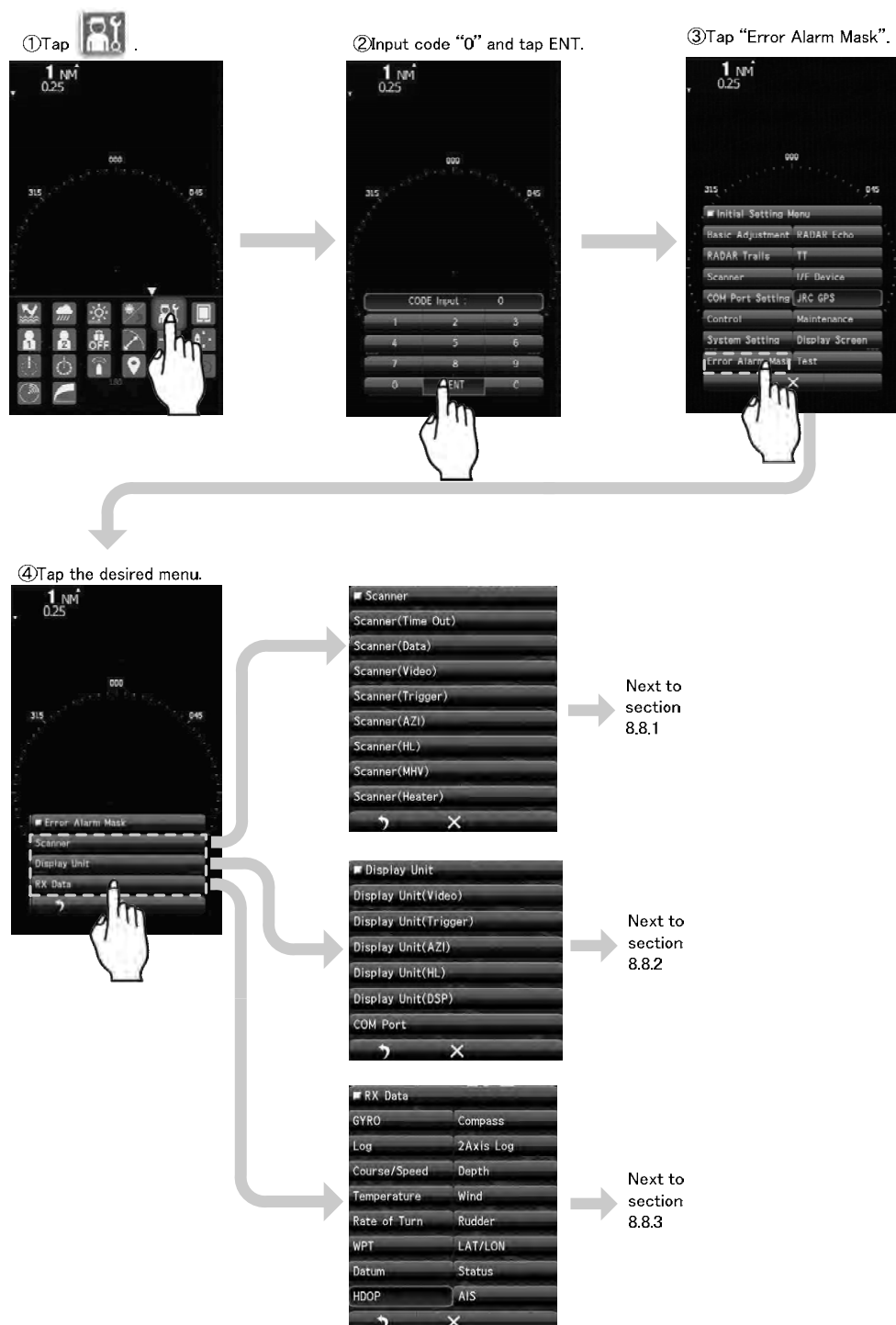

8.8.1 SCANNER

Set the error alarm of scanner.



Other items can be adjusted in the same way.

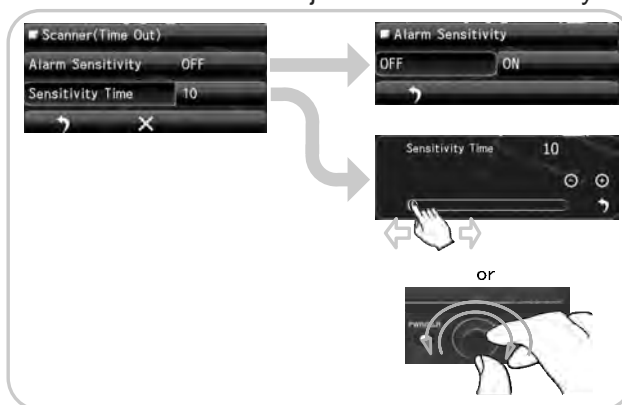

Do not change the set value carelessly. If alarm detection is turned off or detection time is changed, be careful because the alarm may not occur or may be delayed.

8.8.2 DISPLAY UNIT

Set the error alarm of display unit.



Other items can be adjusted in the same way.

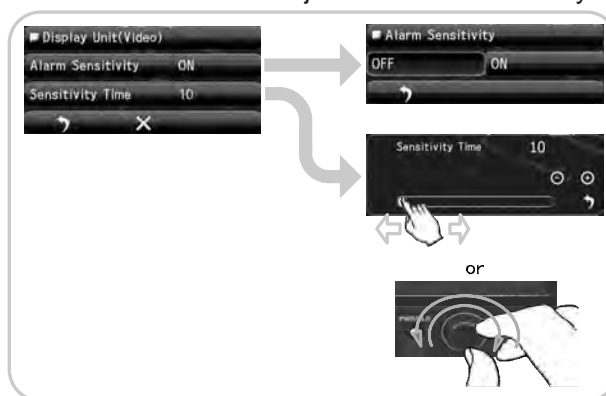

Do not change the set value carelessly. If alarm detection is turned off or detection time is changed, be careful because the alarm may not occur or may be delayed.

8.8.3 RX DATA

Set the error alarm of RX data.





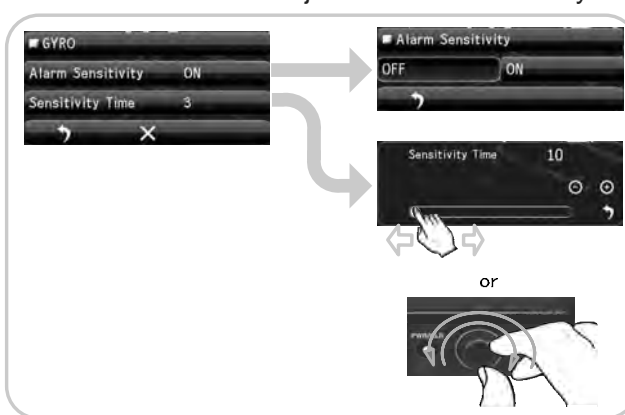

Other items can be adjusted in the same way.



Do not change the set value carelessly. If alarm detection is turned off or detection time is changed, be careful because the alarm may not occur or may be delayed.

Chapter 9 MAINTENANCE AND CHECK

9.1 ROUTINE MAINTENANCE

 DANGER	
	<p>Never carry out internal inspection or repair work of the equipment by users. Inspection or repair work by unauthorized personnel may result in fire hazard or electric shock.</p> <p>For inspection and repair work of equipment components, consult with our branch office, branch shop, sales office, or our distributor in your district.</p>
	<p>When conducting maintenance, make sure to turn the main power off. Failure to comply may result in electrocution.</p>
	<p>Turn off the main power before cleaning the equipment. Especially when a rectifier is used, make sure to turn it off since voltage is still outputted from the rectifier even after the indicator and the radar are turned off. Failure to comply may result in equipment failure, or death or serious injury due to electric shock.</p>

For operating the radar equipment in the good conditions, it is necessary to make the maintenance work as described below. If maintenance is made properly, troubles will reduce.

It is recommended to make regular maintenance work.



Common points of maintenance for each unit are as follow:

Clean the equipment.

Remove the dust, dirt, and sea water rest on the equipment cabinet with a piece of dry cloth. Especially, clean the air vents with a brush for good ventilation.

9.2 MAINTENANCE OF EACH UNIT



9.2.1 SCANNER NKE-1066

 DANGER	
	<p>When conducting maintenance work on the antenna, make sure to turn its main power off. Failure to comply may result in electrocution or injuries.</p>

Note:

- If the radiator front face (radiation plane) is soiled with smoke, salt, dust, paint or birds' droppings, wipe it with a piece of soft cloth wetted with alcohol or water and try to keep it clean at all times. Otherwise, radar beam radiation may attenuate or reflect on it, resulting in deterioration of radar performance.
- Never use solvents of gasoline, benzene, trichloroethylene and ketone for cleaning. Otherwise, the radiation plane may deteriorate.



9.2.2 SCANNER NKE-2044

 DANGER	
	When conducting maintenance work on the antenna, make sure to turn its main power off. Failure to comply may result in electrocution or injuries.

Note:

- If the radiator front face(radiation plane) is soiled with smoke, salt, dust, paint or birds' droppings, wipe it with a piece of soft cloth wetted with alcohol or water and try to keep it clean at all times. Otherwise, radar beam radiation may attenuate or reflect on it, resulting in deterioration of radar performance.
- Never use solvents of gasoline, benzine, trichloroethylene and ketone for cleaning. Otherwise, the radiation plane may deteriorate.

9.2.3 DISPLAY NCD-2256

 DANGER	
	When cleaning the display screen, do not wipe it too strongly with a dry cloth. Also, do not use gasoline or thinner to clean the screen. Failure to comply will result in damage to the screen surface.

Dust accumulated on the screen will reduce clarity and darken the video.
For cleaning it, wipe it with a piece of soft cloth (flannel or cotton).
Do not wipe it strongly with a piece of dry cloth nor use gasoline or thinner.

9.3 PERFORMANCE CHECK

Make operational check on the radar equipment regularly and if any problem is found, investigate it immediately.

Pay special attention to the high voltage sections in checking and take full care that no trouble is caused by any error or carelessness in measurement. Please take note of the results of checking, the reason can be used effectively in the next check work.

Operational check shall be made in accordance with Table 9.3.1 Function Check List in the order as specified in it.

Equipment	Item to be checked	Criteria or Method	Remarks
Scanner Unit	Tuning	Can be adjusted tuning at the manual tune. Observe a weak echo as far possible.	24NM or 48NM range during transmitting
	Magnetron Current	9.3.1 TEST MENU Scanner information The bar is 50% more	
	Antenna Rotation	Rotation speed can change slow, when small Range changing to up.	
Display Unit	Gain can be STC can be FTC can be LCD brilliance can be Marker can be VRM can be EBL can be	Can be correctly controlled using the functional icon.	
	Communication Lines	9.3.8 SELF TEST Line Test	
	Touch panel	9.3.8 SELF TEST Touch Panel Test	
	Key	9.3.8 SELF TEST Key Test	
	Key Light	9.3.8 SELF TEST Key Light Test	
	Buzzer	9.3.8 SELF TEST Buzzer Test	
	Memory	9.3.8 SELF TEST Buzzer Test	
	Error Logging check	9.3.1 TEST MENU Error Log	
	Software check	9.3.1 TEST MENU System Information	

Table 9.3.1 Performance Check List

9.3.1 TEST MENU

The performance status of this radar equipment can be checked on the Test Menu. Please run as needed.

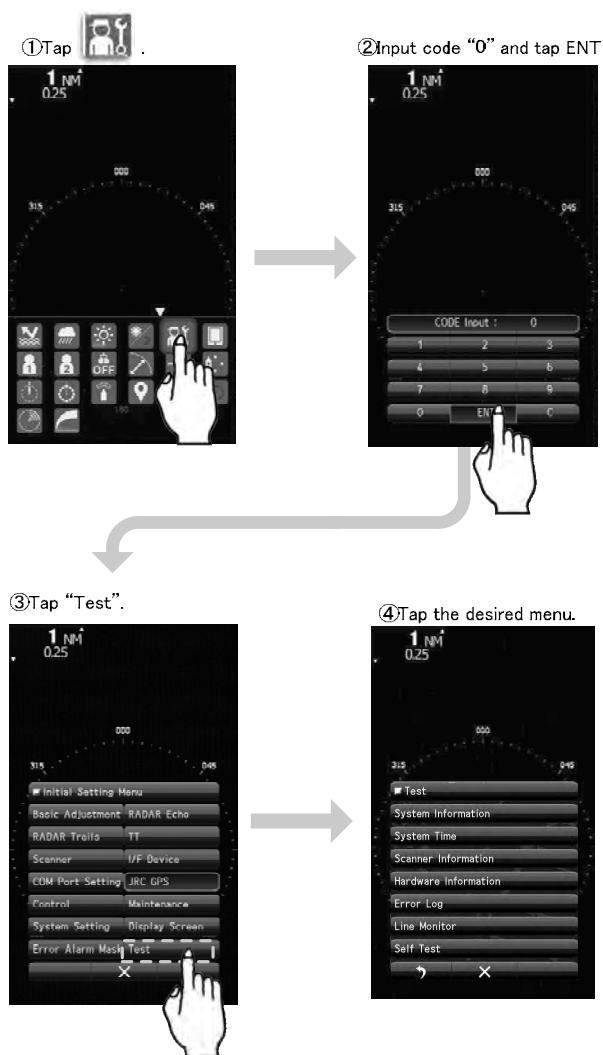

9.3.2 SYSTEM INFORMATION

Displays the current system information. (software version information)

- Indicator Software
- Scanner Software
- System Number
- Boot
- DSP(MC)
- DSP(V)
- Test Bench

9.3.3 SYSTEM TIME

Displays the following system time information.

- Scanner Transmit Time
- Scanner Motor Time
- Scanner Running Time
- Indicator Running Time

9.3.4 SCANNER INFORMATION

Displays the following scanner information.

- Scanner Transmit Power
- Motor Type
- Magnetron Current
(The maximum value of a numeric display of the magnetron current is 127)

9.3.5 HARDWARE INFORMATION

Displays the following hardware information.

- Serial Number

9.3.6 ERROR LOG

The error log displays previously occurred system alarms with the dates and times when they occurred.

9.3.7 LINE MONITOR

Serial communication data can be seen on the built-in Line monitor.

Line monitor can be used to make sure that the serial data are received properly.

9.3.8 SELF TEST



The following tests can be performed.

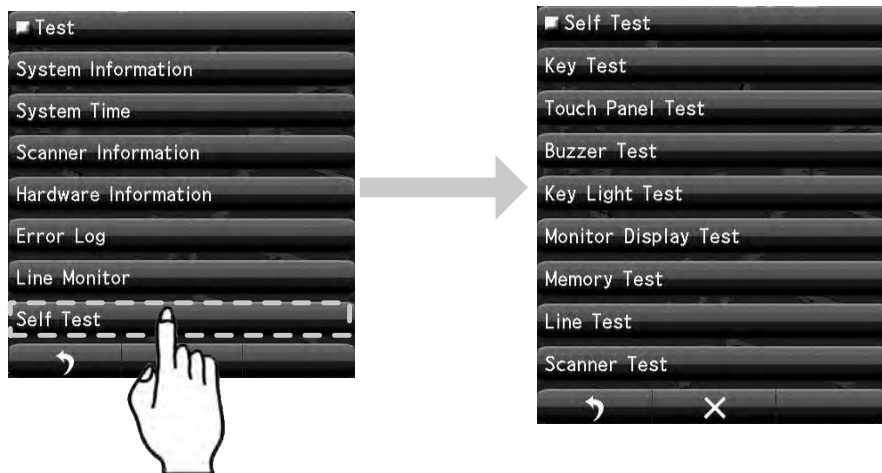



- Key Test
- Buzzer Test
- Key Light Test
- Monitor Display Test
- Memory Test
- Line Test
- Sensor Test



9.4 REPLACEMENT OF MAJOR PARTS

The system includes parts that need periodic replacement. The parts should be replaced as scheduled. Use of parts over their service life can cause a system failure.

 WARNING	
	Direct exposure to electromagnetic waves at close range will have adverse effects on the human body. When it is necessary to get close to the antenna for maintenance or inspection purposes, make sure to turn the indicator power switch to “OFF” or “STBY.”
	When conducting maintenance work, make sure to turn off the power and unplug the power connector J1 of the display unit so that the power supply to the equipment is completely cut off. Some equipment components can carry electrical current even after the power switch is turned off, and conducting maintenance work without unplugging the power connector may result in electrocution, equipment failure, or accidents.

 CAUTION	
	Make sure to shut off the main power before replacing parts. Failure to comply may result in electrocution or equipment failure.
	When replacing magnetrons, make sure to shut off the main power and let the equipment stand for more than 5 minutes to discharge the high-voltage circuit. Failure to comply may result in electrocution.
	Make sure to take off your watch when your hand must get close to the magnetron. Failure to comply may result in damage to the watch since the magnetron is a strong magnet.
	Since it will be high voltage temporarily remains in the circuit even after the main power is shut off. Failure to comply may result in electrocution.

9.4.1 PARTS REQUIRED FOR PERIODIC REPLACEMENT

There are parts required for periodic replacement.

PARTS NAME	INTERVAL
MAGNETRON	4,000 HOURS
MOTOR	10,000 HOURS

In many cases, parts required for periodic replacement works interval hours or more, but if it is over the interval hours it is recommended to replace the early.

The occurrence of phenomenon when parts were consumed)

Magnetron: The radar sensitivity decreases, and it becomes difficult to take the tune.

Motor: Allophone generation and rotation instability or stop.

 CAUTION	
	Parts life time might become remarkably short by vibration of radar mast more than product standard.

9.5 FAULT FINDING

9.5.1 ALARMS AND OTHER DISPLAY LISTS

If any of the following alarm occurs, the system displays the alarm message in red in order to attract the attention of operator. Other messages are displayed with the suitable color which is yellow or blue depending on the level of message importance.

The following table shows alarms and other indications the system displays.

Alarm Code	Alarm Name	Class	Description
S001	Alarm Error	Alarm	Cannot send the alarm because of insufficient message buffer for alarm task.
S002	Scanner(AZI)	Alarm	The BP error bit of scanner communication data is set.
S003	Scanner(HL)	Alarm	The BZ error bit of scanner communication data is set.
S004	Scanner(MHV)	Alarm	The high-voltage modulator error bit of scanner communication data is set.
S005	Scanner(Time out)	Alarm	No reply from the scanner after data communication.
S006	Scanner(Data)	Alarm	Collision occurs when transmitting data to the scanner. Checksum of the received data is different.
S007	Scanner(EEPROM)	Alarm	Stored value error is returned from the scanner when the initial adjustment data is requested. The save operation is not completed when data save is requested to scanner EEPROM.
S008	Scanner(Heater)	Alarm	The MAG heater voltage error bit of scanner communication data is set.
S009	Scanner(Video)	Alarm	The VIDEO error bit of scanner communication data is set.
S010	Scanner(Trigger)	Alarm	The TRIGGER error bit of scanner communication data is set.

Alarm Code	Alarm Name	Class	Description
D001	GPS Port	Alarm	Serial driver error occurs during COM1 port communication.
D002	Gyro/Compass Port	Alarm	Serial drive error occurs during COM2 port communication.
D003	NMEA Port	Alarm	Serial driver error occurs during COM3 port communication.
D004	Scanner Port	Alarm	Serial driver error occurs during COM4 port communication.
D005	GYRO(Time Out)	Alarm	For heading equipment=GYRO, cannot receive valid sentences (including checksum error) which had been received properly.
D006	Log(Time Out)	Alarm	For speed equipment=log, cannot receive valid sentences (including checksum error) which had been received properly.
D007	GYRO(Data)	Alarm	For heading equipment=GYRO, the GYRO error bit of NSK communication data is set.
D008	Log(Data)	Alarm	For speed equipment=log, the LOG error bit of NSK communication data is set.
D009	Heading(Time Out)	Alarm	For heading equipment=compass, cannot receive valid NMEA bearing sentences (including checksum error) which had been received properly.
D010	Heading(Data)	Alarm	For heading equipment=compass, cannot receive valid NMEA bearing data which had been received properly.
D011	2AXG(Time Out)	Alarm	For speed equipment =2-axis log, cannot receive valid VBW sentences(including checksum error) which had been received properly.
D012	2AXG(Data)	Alarm	For speed equipment=2-axis log, cannot receive valid VBW ground data which had been received properly.
D013	GPS(Time Out)	Alarm	Cannot receive valid GPS sentences(including checksum error) which had been received properly.
D014	GPS(Position)	Alarm	Cannot receive valid position data which had been received properly.
D015	GPS(Datum)	Alarm	Cannot receive valid geodetic data which had been received properly.
D016	GPS(Speed)	Alarm	For Speed equipment=GPS, cannot receive valid speed data which had been received properly.
D017	GPS(Status)	Alarm	Received GPS fixing status error (invalid) data
D018	Depth(Time Out)	Alarm	Cannot receive valid depth sentences (including checksum error) which had been received properly.
D019	Depth(Data)	Alarm	Cannot receive valid depth data which had been received properly.
D020	TEMP(Time Out)	Alarm	Cannot receive valid water temperature sentences which had been received properly.
D021	TEMP(Data)	Alarm	Cannot receive valid water temperature data which had been received properly.
D022	Wind(Time Out)	Alarm	Cannot receive valid wind direction/wind velocity sentences (including checksum error) which had been received properly.
D023	Wind True(Data)	Alarm	Cannot receive valid wind direction/wind velocity (true) data had been received properly.
D024	Wind Relative(Data)	Alarm	Cannot receive valid wind direction/wind velocity (relative) data had been received properly.
D025	Turn(Time Out)	Alarm	Cannot receive valid turning ratio sentences (including checksum error) which had been received properly.
D026	Turn(Data)	Alarm	Cannot receive valid turning ratio data which had been received properly.
D027	Rudder(Time Out)	Alarm	Cannot receive valid steering direction sentences (including checksum error) which had been received properly.
D028	Rudder(Data)	Alarm	Cannot receive valid steering direction data which had been received properly
D029	AIS(Time Out)	Alarm	For AIS function=ON, cannot receive valid AIS data (including checksum error) which had been received properly.
D030	AIS(Data)	Alarm	For AIS function=ON, cannot receive valid AIS data which had been received properly.

Alarm Code	Alarm Name	Class	Description
D031	AIS(Alarm001)	Alarm	For AIS function=ON, an error from the AIS receiver is received(ALR).
D032	AIS(Alarm002)	Alarm	For AIS function=ON, an error from the AIS receiver is received(ALR).
D033	AIS(Alarm003)	Alarm	For AIS function=ON, an error from the AIS receiver is received(ALR).
D034	AIS(Alarm004)	Alarm	For AIS function=ON, an error from the AIS receiver is received(ALR).
D035	AIS(Alarm005)	Alarm	For AIS function=ON, an error from the AIS receiver is received(ALR).
D036	AIS(Alarm006)	Alarm	For AIS function=ON, an error from the AIS receiver is received(ALR).
D037	AIS(Alarm008)	Alarm	For AIS function=ON, an error from the AIS receiver is received(ALR).
D038	AIS(Alarm025)	Alarm	For AIS function=ON, an error from the AIS receiver is received(ALR).
D039	AIS(Alarm026)	Alarm	For AIS function=ON, an error from the AIS receiver is received(ALR).
D040	AIS(Alarm029)	Alarm	For AIS function=ON, an error from the AIS receiver is received(ALR).
D041	AIS(Alarm030)	Alarm	For AIS function=ON, an error from the AIS receiver is received(ALR).
D042	AIS(Alarm032)	Alarm	For AIS function=ON, an error from the AIS receiver is received(ALR).
D043	AIS(Alarm035)	Alarm	For AIS function=ON, an error from the AIS receiver is received(ALR).
D044	Set Gyro	Status	Requires setting of true bearing.
D045	DSP(Video)	Alarm	DSP detects VIDEO error.
D046	DSP(Trigger)	Alarm	DSP cannot receive TI interrupt.
D047	DSP(AZI)	Alarm	DSP cannot receive BP interrupt.
D048	DSP(HL)	Alarm	DSP cannot receive BZ interrupt.
D049	DSP Error	Alarm	Abnormal operation(infinite loop) of DSP.
D050	LAT(Out of Bounds)	Caution	The own ship's latitude is 80 degrees or more (indicating that some functions are limited). Display AIS, waypoint, mark/line, own ship trail, etc. for 80 degrees or more. Input operations for 80 degrees or more (refer to "High Latitude "alarm)
D051	TT(Out of Range)	Alarm	TT is too far to be tracked.
D053	Flash ROM Error	Alarm	Initialization error of flash ROM file system during startup.
D054	USB Error	Alarm	Initialization error of USB during startup.
Alarm Name		Class	Description
Area1(Approach)		Alarm	Echo in area1.
Area1(Seccession)		Alarm	No echo in area1.
Area1(Out of Range)		Alarm	Rectangle area 1 is out of range. Creation of area 1 is out of range.
Area2(Approach)		Alarm	Echo in area2.
Area2(Seccession)		Alarm	No echo in area2.
Area2(Out of Range)		Alarm	Rectangle area 2 is out of range. Creation of area 2 is out of range.
TT(CPA/TCPA)		Alarm	TT is changed to a dangerous ship
TT(New Target)		Alarm	TT is automatically acquired.

Alarm Name	Class	Description
TT(Lost)	Alarm	TT is lost.
GPS(Error)	Status	Failed to set GPS.
GPS(HDOP)	Caution	Received excessive HDOP value beyond the setting.
TM Reset	Status	For TM, the own ship position is out of 60% of the radius of PPI.
Max Point	Status	Exceeded the maximum number of marks.
In Preparing USB	Status	Checking the dedicated folder or create the dedicated folder to the USB memory.
USB Ready	Status	USB memory is available
File Not Found	Status	File does not exists.
USB Memory Not Set	Status	USB memory does not exists.
File Read Error	Caution	Failed to load the file.
File Write Error	Caution	Failed to write the file.
Not Enough Space	Status	Insufficient capacity.
In Formatting USB	Status	The format of the USB memory.
USB Format Finish	Status	Format of the USB memory is complete.
Format Error	Caution	Failed to format
Num of files Over	Caution	Writing data to the USB memory in which the number of the file has reached to the maximum.
File Erase Error	Caution	Failed to delete the file
TT(Max Target)	Status	Manually acquired when the number of acquisition reached maximum. Detected when DSP tries to acquire 11 targets or more. DSP notifies the maximum target alarm occurrence of automatic acquisition tot the TT process task, then the TT process task notifies it to the alarm task.
Range Scale Limit	Status	Operations functionally restricted for certain range. Off center operations in range where off center is not available. TM setting operations in range where TM setting is not available.
High Latitude	Status	Operations for the position of latitude 80 degrees or more. MOB input. Event mark input. Input/moving marks. Input/moving/inserting lines. Creating latitude/longitude alarm area.
Invalid Version	Status	Program is loading a file with an incompatible version. Internal setting Marks/lines Option languages STC curve
TT(Out of Range)	Status	TT is too far to be tracked.
Self Test NG	Caution	Diagnosis NG.
Timed TX	Status	Start transmission in timed TX mode
No Rotation	Status	Start transmission without antenna rotation

9.6 TROUBLE SHOOTING

As this radar equipment includes complicated circuits, it is necessary to request a specialist engineer for repair or instructions for remedy if any circuit is defective.

There are also troubles by the following causes, which should be referred to in checking or repair work.

- Poor Contact in Terminal Board of Inter-Unit Cables.
- Poor contact in terminal board.
- The cable end is not fully connected, that it, contacted with earthed another terminal.
- Disconnected cable wire.
- Poor Contact of Connector with in Unit.

9.6.1 SPECIAL PARTS

Location	Parts No.	Name	Type	Code	Manufacture
NKE-1066	V101	Magnetron	M1624	5VMAA00120	New JRC
NKE-2044	V101	Magnetron	MSF1421B	5VMAA00092	New JRC
NKE-2044	A101	Circulator	FCX68R	5AJIX00027	Orient Microwave
NKE-2044	A102	Diode Limiter	NJS6930	5ATBT00006	New JRC

9.6.2 CIRCUIT BLOCK TO BE REPAIRED

JMA-1032

Location	Circuit Block	Type	Remarks
Scanner	Motor unit	H-7BDRD0053	
Scanner	Transmitter/ receiver / Microwave unit	NZT-1066	Include Magnetron and Chassis
Display Unit	LCD Panel unit	NZP-2256	Include Process Circuit CDC-1433

JMA-1034

Location	Circuit Block	Type	Remarks
Scanner	Motor unit	H-7BDRD0052A	
Scanner	Modulation circuit	CME-397	
Scanner	2ft Radar Antenna	NAX-96	Include Horn Antenna
Scanner	Transmitter/ receiver	NZT-2044	Include Magnetron
Scanner	Receiver	NRG-242	
Display Unit	LCD Panel unit	NZP-2256	Include Process Circuit CDC-1433

Chapter 10 AFTER-SALE SERVICE

10.1 KEEPING PERIOD OF MAINTENANCE PARTS

Keeping period of maintenance parts is ten years from the production is discontinued.

10.2 WHEN YOU REQUEST FOR REPAIR

If you suppose the product may be out of order, read the description in "9.5 FAULT FINDING" and "9.6 TROUBLE SHOOTING", and check the suspected point again.

If it is still out of order, you are recommended to stop operation of the equipment and consult with the dealer from whom you purchased the product, or our branch office in your country or district, the sales department in our main office in Tokyo.

- Repair within the Warranty Period

If any failure occurs in the product during its normal operation in accordance with the instruction manual, the dealer or JRC will repair free of charge.

In case that any failure is caused due to misuse, faulty operation, negligence or force major such as natural disaster and fire, the product will be repaired with charges.

- Repair after the Warranty Period.

If any defective function of the product is recoverable by repair, the repair of it will be made at your own charge upon your request.

- Necessary Information for Repair

- ☆ Product name, model, manufacturing date and serial number

- ☆ Trouble conditions (as detailed as possible. Refer to page "10.4 Radar Failure Check List".)

- ☆ Name of company/organization, address and telephone number

10.3 RECOMMENDED MAINTENANCE

The performance of the product may deteriorate due to the secular change of the parts used in it, though such deterioration depends upon the conditions of operation.

So checkup and maintenance is recommendable for the product in addition to your daily care.

For maintenance, consult with the near-by dealer or our sales department.

Such maintenance will be made with charges.

For further details of after-sale service, contact the JRC Offices.

10.4 RADAR FAILURE CHECK LIST

Radar Failure Check List

When placing an order for repair of the product, it is requested that you could confirm the check items and fill the results and sent the sheet to our contact.

If there is any unclear items, contact the ship on which the product is installed, and give the correct information on the product.

Ship name: _____ Phone: _____ Fax: _____
 Radar general model name: JMA - _____ Serial No. : _____
 (Write the full model name correctly)

(1) Check the following items in the order of the number, and circle the applicable answer between YES or NO. If the item cannot be determined as YES or NO, explain in detail in the item (17), others.

(2) If any of the items (1) to (5) is marked as NO, check the fuse of the product (refer to Section 9.1.2 and 9.2).

(3) Check the items (4) to (16) while the transmission (TX) is ON.

*Functions mentioned in the items (14), (15) and (16) may be optional, answer is not necessary.

No.	Check Item	Result	
		YES	NO
(1)	Power can be turned on. (The lamp on the Operation unit is lit)	YES	NO
(2)	A few minutes after powering-on, it will become standby status .	YES	NO
(3)	When powering-on (or TX ON), LCD monitor something is lit.	YES	NO
(4)	The antenna rotates at the transmission (TX) ON. (Check the following items while transmission is ON)	YES	NO
(5)	Current is supplied to the magnetron. (Refer to the instruction manual)	YES	NO
(6)	Turning is enabled. (Check with the range of 6 NM or more)	YES	NO
(7)	Fixed marker is displayed.	YES	NO
(8)	VRM is displayed.	YES	NO
(9)	While noise is displayed while set at SEA and RAIN minimum, GAIN maximum, IR-OFF and range 48 NM.	YES	NO
(10)	Target reflection echo is displayed.	YES	NO
(11)	Sensitivity of reflection echo is normal.	YES	NO
(12)	EBL is displayed.	YES	NO
(13)	Cursor mark moves.	YES	NO
*(14)	GYRO course can be set and normally displayed.	YES	NO
*(15)	LOG speed can be normally displayed.	YES	NO
*(16)	Target tracking function works normally.	YES	NO

(17) Others (Error message, etc.) _____

Chapter 11 DISPOSAL

11.1 DISPOSAL OF THE UNIT

When disposing of this unit, be sure to follow the local laws and regulations for the place of disposal.

11.2 DISPOSAL OF USED MAGNETRON

A magnetron is used for the scanner (NKE-1066 and NKE-2044).

☆ When the magnetron is replaced with a new one, return the used magnetron to our dealer or business office.

For detail, consult with our dealer or business office.

11.3 CHINA ROHS

有毒有害物质或元素的名称及含量

(Names & Content of toxic and hazardous substances or elements)

形式名(Type): **JMA-1030 Series**

名称(Name): **RADAR**

部件名称 (Part name)	有毒有害物质或元素 (Toxic and Hazardous Substances and Elements)					
	铅 (Pb)	汞 (Hg)	镉 (Cd)	六价铬 (Cr6+)	多溴联苯 (PBB)	多溴二苯醚 (PBDE)
雷达天线单元 (Scanner Unit)	×	×	○	×	×	×
收发信单元 (Transmitter-receiver Unit)	×	×	×	×	×	×
主船内装置 (Inboard Unit) · 显示装置 (Display Unit) · 键盘装置 (Operation Unit) · 信号处理装置 (RADAR Process Unit)	×	×	×	×	×	×
外部设备 (Peripherals) · 选择 (Options) · 电线类 (Cables) · 手册 (Documents)	×	×	×	×	×	×
<p>○: 表示该有毒有害物质在该部件所有均质材料中的含量均在SJ/T11306-2006 标准规定的限量要求以下。 (Indicates that this toxic, or hazardous substance contained in all of the homogeneous materials for this part is below the requirement in SJ/T11363-2006.)</p> <p>×: 表示该有毒有害物质至少在该部件的某一均质材料中的含量超出SJ/T11363-2006 标准规定的限量要求。 (Indicates that this toxic or hazardous substance contained in at least one of the homogeneous materials used for this part is above the limit requirement in SJ/T 11363-2006.)</p>						

Chapter 12 SPECIFICATIONS



NKE-1066



NKE-2044

JMA-1030 Series



NCD-2256

12.1 SCANNER DIMENSION

12.1.1 NKE-1066

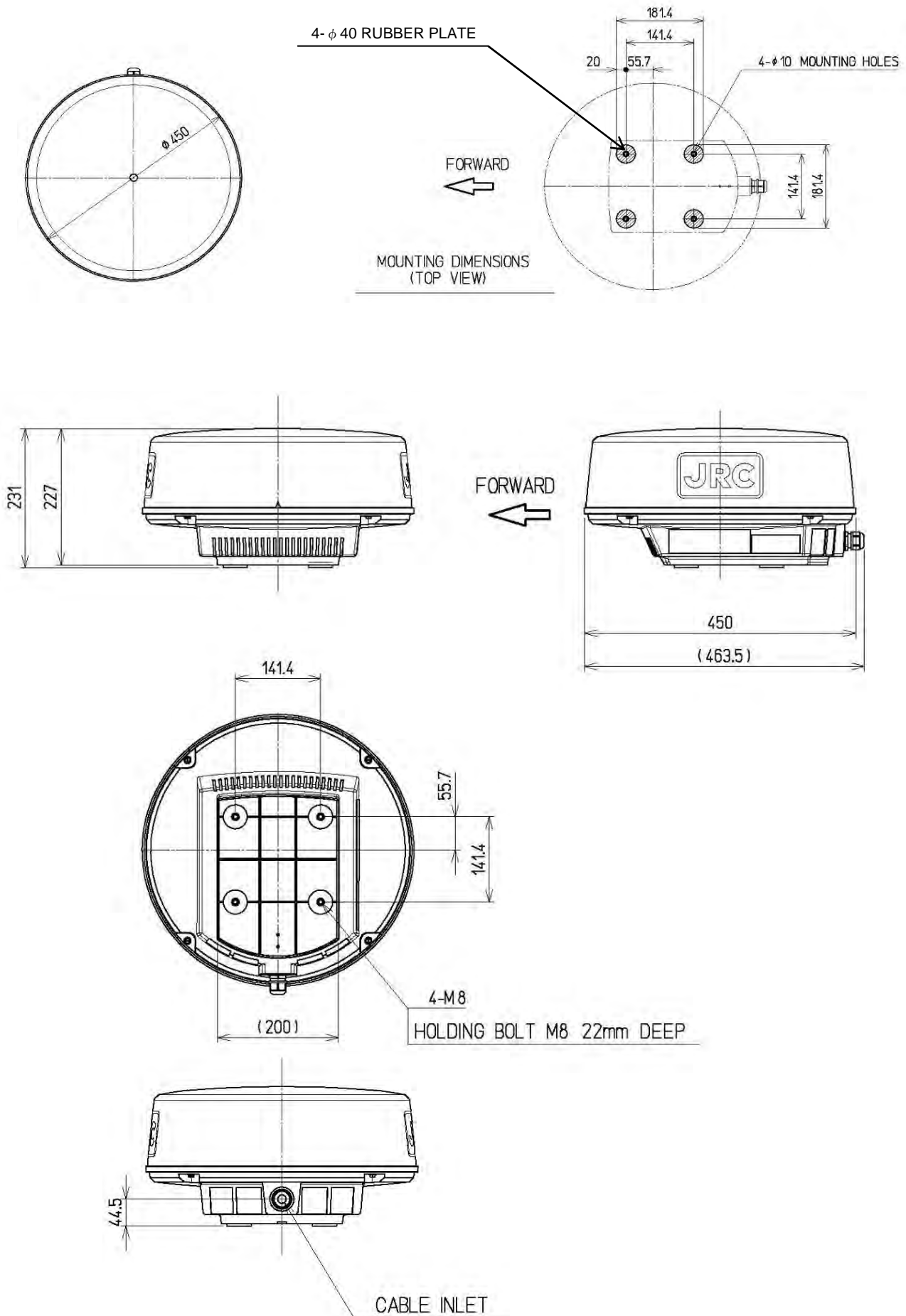

12.1.2 NKE-2044

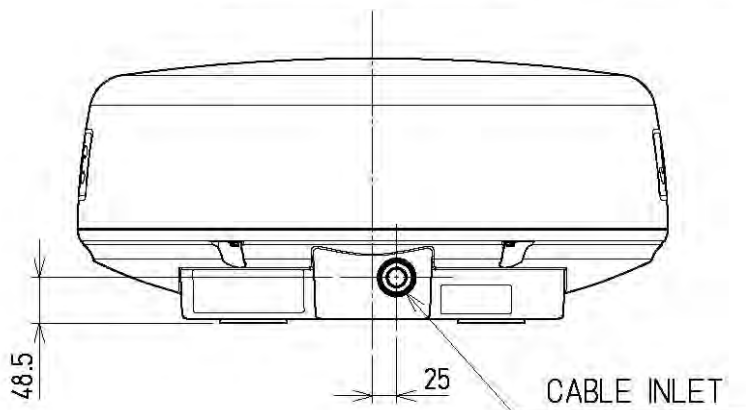
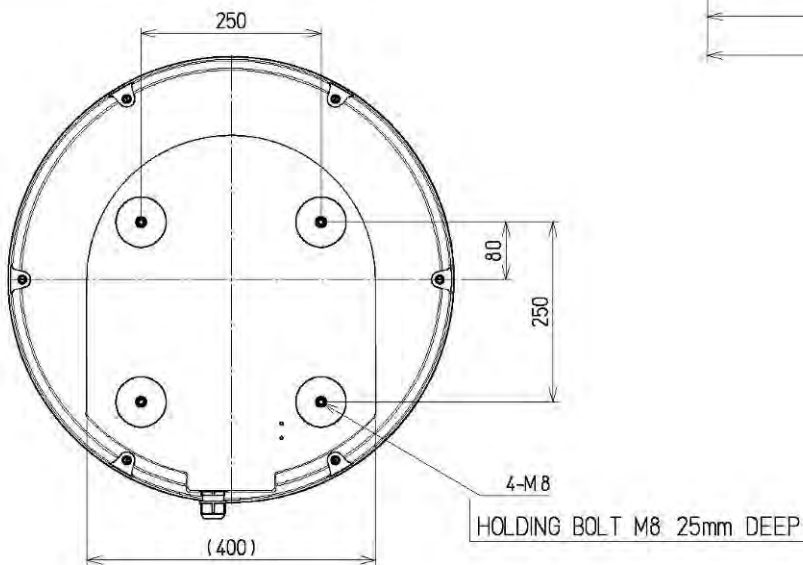
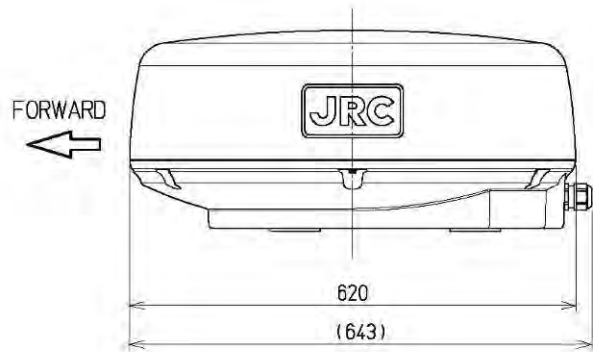
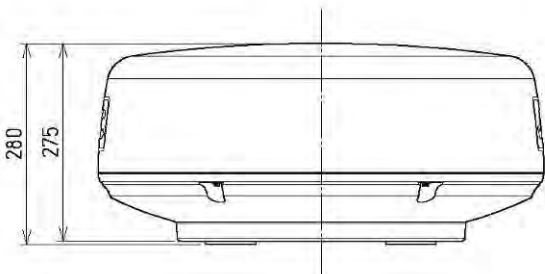
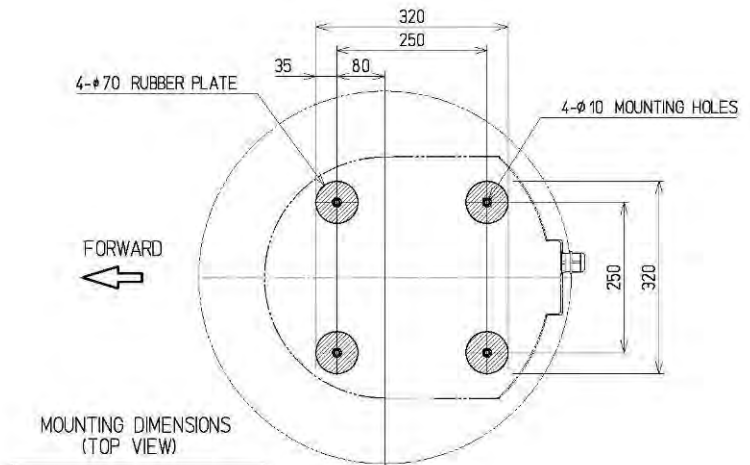
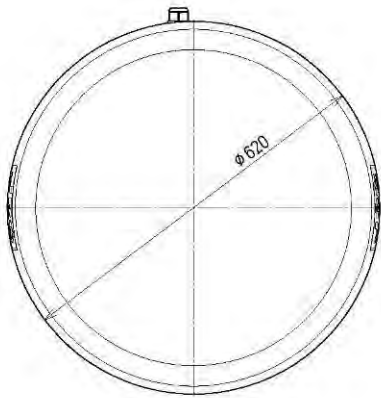

12.2 DISPLAY DIMENSION

12.2.1 NCD-2256

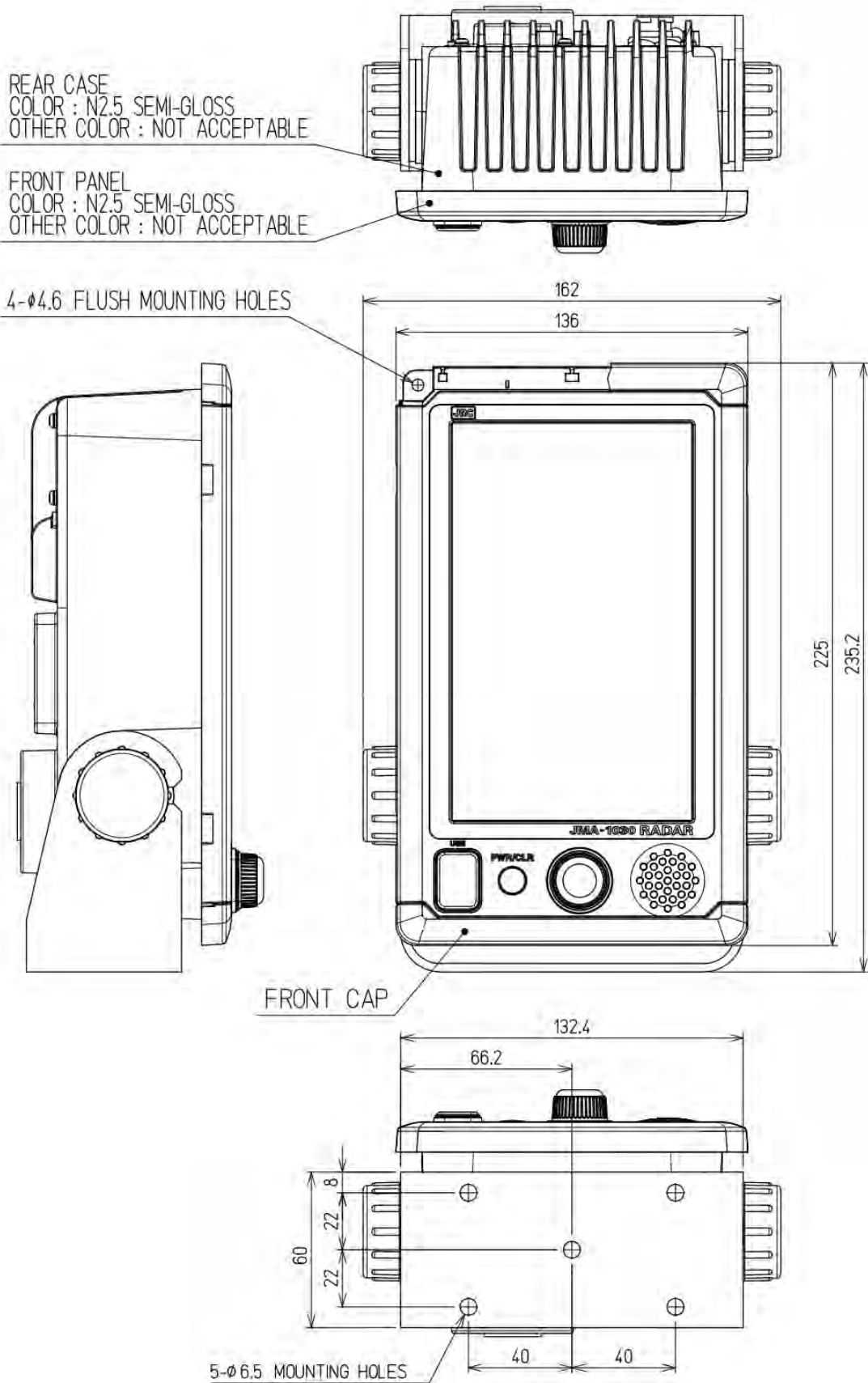

OUTLINE DIMENSIONS		PERMISSIBLE OUTLINE DIMENSIONAL DEVIATIONS	PERMISSIBLE MOUNTING DIMENSIONAL DEVIATIONS
OVER	TO		
3	6	±0.5	±0.5
6	30	±1	
30	120	±1.5	
120	400	±2.5	±1
400	1000	±4	±2

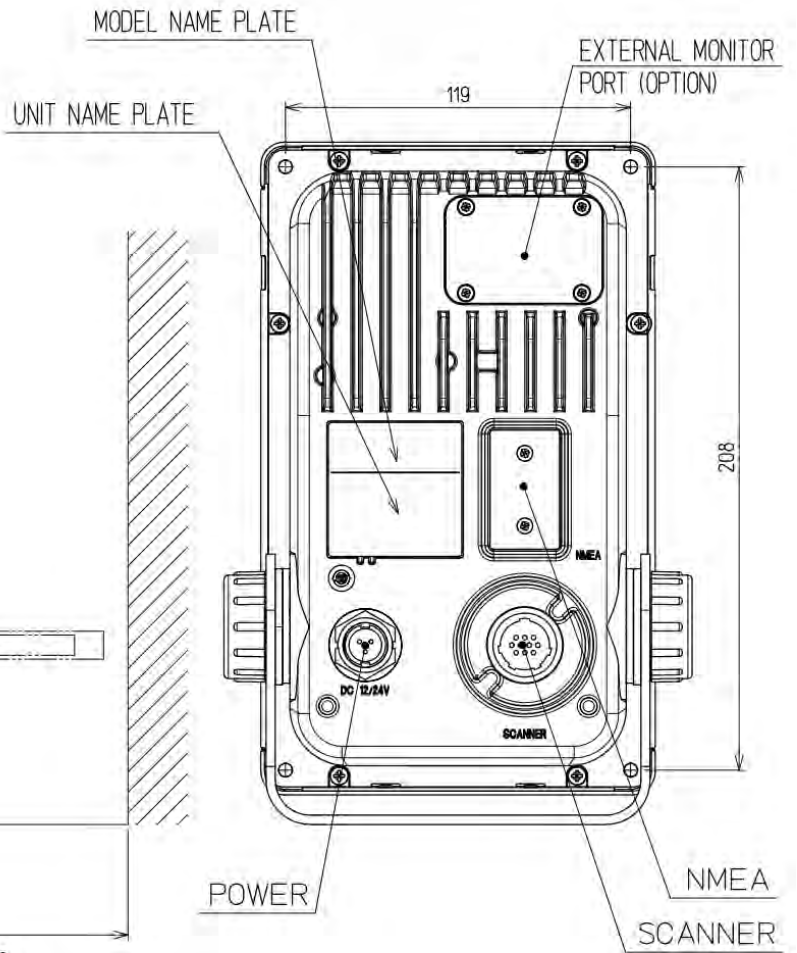
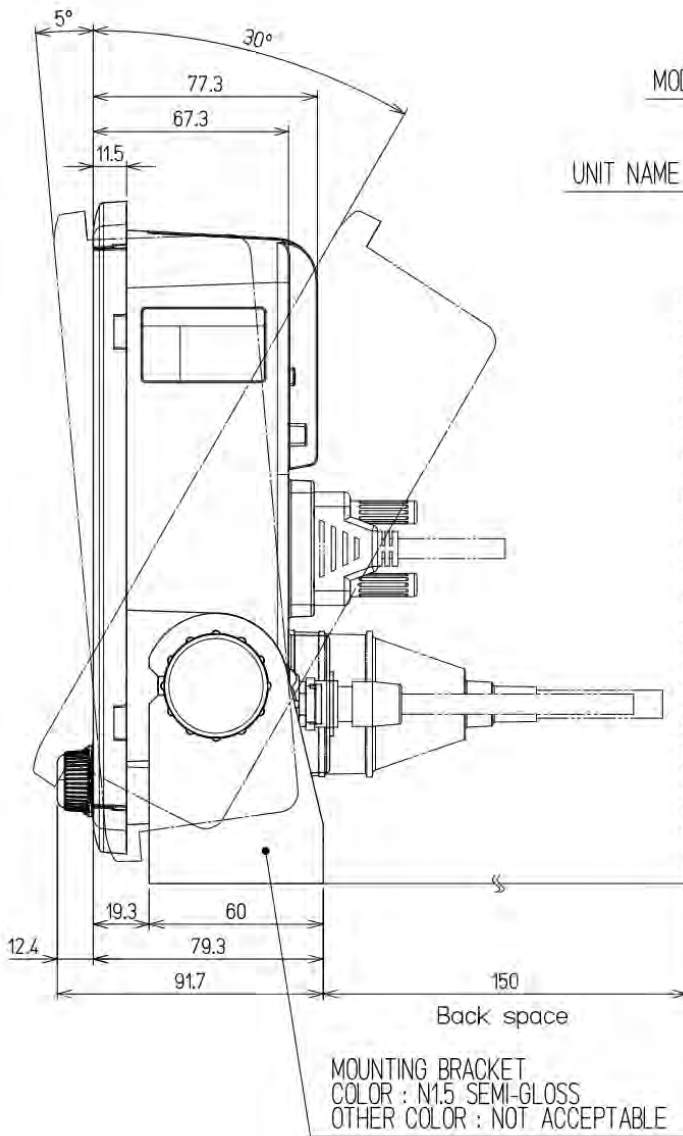

12.3 EQUIPMENT OUTLINE

This equipment is a marine radar for vessels and work boats which consists of the display unit including 7 inch wide VGA color LCD Monitor unit with touch sensor, Keyboard unit, Processing unit and consists of the 1.5 ft /2ft radome type scanner unit. The processing unit uses SOC (LUPIM) developed by JRC and the LCD monitor unit uses panel with touch sensor (resistance film type). The operation can be realized intuitive and simple.

12.3.1 CONFIGURATION

- 1) Display unit NCD-2256
 - Integrated the 7 inch wide VGA color LCD Monitor unit, Keyboard unit and Processing unit
- 2) Scanner unit
 - X-band 1.5ft(4kW) radome type is NKE-1066
 - X-band 2ft(4kW) radome type is NKE-2044

12.3.2 FEATURE

- 1) The screen resolution is 800x480dots (WVGA).
The LCD monitor unit with touch sensor (resistance film type).
- 2) Highly efficient signal processing using the SOC including DSP.
- 3) TT and AIS function are prepared by SOC using.

12.3.3 RADAR MODEL

JMA-1032	1.5ft Scanner unit
JMA-1034	2ft Scanner unit

12.4 GENERAL SPECIFICATIONS

(1) Class of Emission	P0N	
(2) Display	Color Raster Scan	
(3) Display capability	WVGA (800x480dots) Screen	
(4) Screen	7-inch Color LCD with touch sensor (resistance film type)	
(5) Range Scale	0.0625, 0.125, 0.25, 0.5, 0.75, 1.5, 3, 6, 12, 24, 48NM (48 NM: only 2feet type scanner is available) User can add 1, 2, 4, 8, 16, and 32NM (32 NM: only 2feet type scanner is available)	
(6) Range Resolution	Less than 30m	
(7) Minimum Detective Range	Less than 40m	
(8) Range Accuracy	Less than 1% of the maximum distance of the range scale in use or less than 15m whichever is larger.	
(9) Bearing Accuracy	Less than $\pm 1^\circ$	
(10) Bearing Indication	RM: Head-up, North-up, Course-up TM: North-up, Course-up	
(11) Ambient Condition		
Standards	IEC60945 Ed.4.0	
Temperature		
Scanner	Operation: -25 to +55°C / Storage: -25 to +70°C	
Other Unit except Scanner	Operation: -15 to +55°C / Storage: -15 to +70°C	
Relative Humidity	+40°C, 93%	
Vibration	2 to 13.2 Hz, amplitude \pm 1mm 13.2 to 100 Hz, 0.7 G	
Velocity of the wind	100kn	
Waterproof/dustproof	Scanner	IP26
	Display unit	IP55
(12) Power Supply Input	DC 10.8-31.2V (DC12-24V-10%+30%)	
(13) Power Consumption	Approx. 50W (NKE-1066/NKE-2044). Maximum: 50W (NKE-1066: SP1, NKE-2044: LP2 transmitting)	
(14) Pre heat time	Approx. within 1min30sec.	
(15) Display unit	Refer to Display unit Specifications	
(16) Inter-unit Cables	Using common scanner connecting cable CFQ9924-10 Standard Length 10m Maximum cable length 30m (option)	

12.5 SCANNER

12.5.1 SCANNER (NKE-1066) SPECIFICATION

(1) Dimensions	Height 231mm×Diameter of radome 450mm	
(2) Mass	Approx. 5kg	
(3) Polarization	Horizontal (antenna length 1.5 feet)	
(4) Antenna Directivity	Horizontal Beam Width (-3dB)	5.2°
	Vertical Beam Width (-3dB)	25°
Side lobe Level	Less than -20dB (less than ±10° from the main lobe)	
(5) Rotation	Approx. 27rpm (16/20/24/27/30/36/42/48rpm can be set)	
(6) Transmitting Frequency	9410±30MHz	
(7) Peak Power	4 kW	
(8) Transmitting Tube	Magnetron [M1624]	
(9) Pulse width/ Repetition Frequency (Bandwidth)	SP1: 0.08μs/4000 Hz (Wide 20MHz)	
	SP2: 0.08μs/2250 Hz (Wide 20MHz)	
	SP3: 0.13μs/1700 Hz (Wide 20MHz)	
	MP1: 0.25μs/1700 Hz (Middle 6MHz)	
	MP2: 0.5μs/1200 Hz (Narrow 3MHz)	
	LP1: 0.8μs/750 Hz (Narrow 3 MHz)	
	(S: Short pulse, M: Middle pulse, L: Long pulse)	
(10) Range Information	0.0625NM	SP1
	0.125NM	SP1
	0.25 NM	SP1
	0.5 NM	SP1 / MP1
	0.75 NM	SP2 / MP1
	1.5 NM	SP2 / MP1 / MP2
	3 NM	SP3 / MP1 / MP2
	6 NM	MP2 / LP1
	12 NM	MP2 / LP1
	24 NM	LP1
(11) Duplexer	Circulator + Diode Limiter (Diode Limiter is included in the frontend)	
(12) Front End Module	MIC	
(13) IF Frequency	60MHz	
(14) IF AMP	Log Amplifier (Gain: more than 90dB)	
(15) Overall Noise Figure	6dB (Average)	
(16) Tuning	Manual/Auto	

12.5.2 SCANNER (NKE-2044) SPECIFICATION

(1) Dimensions	Height 280mm×Diameter of radome 620mm
(2) Mass	Approx. 10kg
(3) Polarization	Horizontal (antenna length 2 feet)
(4) Directional Characteristic	Horizontal Beam Width (-3dB) 4° Vertical Beam Width (-3dB) 25°
Side lobe Level	-21dB or less (less than ±10° from the main lobe)
(5) Rotation	Approx. 27rpm (16/20/24/27/30/36/42/48rpm can be set)
(6) Transmitting Frequency	9410±30MHz
(7) Peak Power	4 kW
(8) Transmitting Tube	Magnetron [MSF1421B]
(9) Pulse width/ Repetition Frequency (Bandwidth)	SP1: 0.08μs/4000 Hz (Wide 20MHz) SP2: 0.08μs/2250 Hz (Wide 20MHz) SP3: 0.13μs/1700 Hz (Wide 20MHz) MP1: 0.25μs/1700 Hz (Middle 6MHz) MP2: 0.5μs/1200 Hz (Narrow 3MHz) LP1: 0.8μs/750 Hz (Narrow 3MHz) LP2: 1.0μs/650Hz (Narrow 3MHz) (S: Short pulse, M: Middle pulse, L: Long pulse)
(10) Range Information	0.0625NM SP1 0.125NM SP1 0.25 NM SP1 0.5 NM SP1 / MP1 0.75 NM SP2 / MP1 1.5 NM SP2 / MP1 / MP2 3 NM SP3 / MP1 / MP2 6 NM MP2 / LP1/ LP2 12 NM MP2 / LP1/ LP2 24 NM LP2 48 NM LP2
(11) Duplexer	Circulator + Diode Limiter
(12) Front End Module	MIC
(13) IF Frequency	60MHz
(14) IF AMP	Log Amplifier (Gain: more than 90dB)
(15) Overall Noise Figure	6dB (Average)
(16) Tuning	Manual/Auto

12.6 DISPLAY

12.6.1 INTEGRATED DISPLAY UNIT (NCD-2256)

- | | |
|--|--|
| 1) Structure | Desk Top Integrated Type
(LCD Monitor Unit/Keyboard Unit/Processor Unit Integrated Structure)
Vertical installation only desk top integrated type
Option: Overhead Mounted kit installation |
| 2) Dimensions | Height 235.2mm x Width 162mm x Depth 77.3mm
(The U style mount base and the both sides knob bolts are included.) |
| 3) Mass | Approx. 1.7kg(Without Sun cover) |
| 4) Tune Method | Manual / Auto
(Bar-graph indication is displayed at the time of adjustment.) |
| 5) STC (SEA) | Manual / Auto |
| 6) FTC (RAIN) | Manual / Auto |
| 7) Radar Interference Rejection | Built-in (The effect can be adjusted by three stages.) |
| 8) Bearing Marker | 360° in 5° digit |
| 9) Heading Line | Electronic |
| 10) Off Center | move to the defined coordinates of 4 patterns
(4 patterns are back side 64dots, left side 92dots, front side 92dots, right side 92dots from the default center position)
Transition of the radar trails is possible during Off Center mode. |
| 11) True Motion Unit | Built-in (Not available at the maximum range) |
| 12) True Motion Reset Position | 40% of radius of any range |
| 13) Radar trail indication | True motion mode: Only true motion trails
Relative motion mode: True or relative motion trails
Trail time length: 15 sec to 15 min/Continuous
30 sec to 30 min/Continuous
1 min to 1 hr/Continuous
30 min to 24 hr/Continuous
Arbitrary trail time length can be displayed at any time.
Possible to display time series trail and continuous trail by color classification. |
| | * When switching to true/relative trails, the radar trails are cleared. Transition of the trails is possible during Off Center mode (Relative motion). (Scroll)
When the bearing mode is switched (RM (T), TM), the radar trails are taken over at between RM (T) and TM. |
| 14) Variety of Pulse width SP1/ SP2/ SP3/ MP1/ MP2/ LP1/ LP2 | (LP2 is JMA-1034 only) |
| 15) Target enhance | 3 stages |

16) Plotting	3 kinds: 4 marks, LINE, MEMO (MEMO is not fixed to the latitude and longitude) 7 sizes (1, 3, 5, 7, 9, 11, 13) 4 colors (White, Magenta, Yellow, Red) The maximum number of points: 2000 (total of 3 kinds)
17) Display color	
Radar echo	16 stages, 8 colors (Yellow, Green, Blue, White, Magenta, Gold, Amber, Color)
Radar trails	16 stages, Time trails: 3 colors (Green, Blue, Cyan) Continuous trails: 3 colors (Green, Blue, Cyan)
Background	PPI: 3 colors (Black, Blue, White)
Characters	7 colors (White, Cyan, Green, Black, Red, Gold, Amber)
AIS/TT	3 colors (Cyan, Green, White)
EBL/VRM	4 colors (Cyan, Black, Magenta, White)
Cursor	4 colors (White, Red, Magenta, Yellow)
Own Ship's	6 colors (Cyan, Green, Red, White, Gold, Amber)
Range Ring	6 colors (Cyan, Green, Red, White, Gold, Amber)
Alarm Zone	5 colors (White, Green, Orange, Black, Red)
18) Simulator	Built-in
19) Multiple languages	English, Spanish, Turkish, Indonesian, Thai, Malay, Vietnamese, Chinese, Russian, Korean, Japanese, Other one optional language
20) Range Unit	NM, km, sm
21) Navigation information during STBY	Built-in
22) AIS information display	List display (Call sign, Ship name), On PPI (Can display AIS mark with ship name)
23) Waypoint display	One mark of position information

12.6.2 OPERATIONAL PART

1) Structure	Integrated on the display unit
2) Key	PWR /CLR Short push: Power ON (at the time of Power OFF) Long push: Power OFF PWR / CLR Short push: input cancel, back to a up-layer
3) Knob Controller	PUSH : Menu or Icon selection and execution, control EBL/VRM, number input, Enter, etc. PUSH + rotation: Brilliance control, Move Cursor up and down
4) Touch control	Tap: Menu or Icon selection and execution, control, etc. Double tap: Brilliance menu Icon Double tap: EBL/VRM, Cursor disappear Icon Long tap: Entry of short cut Icon

12.6.3 AIS FUNCTION (STANDARD BUILT IN)

- | | |
|---------------------------------|--|
| 1) Display | |
| Number of targets | Up to 50 targets (stores up to 1,000 ship static data) |
| Target information | Displays MMSI, call sign, ship name, COG, SOG, CPA, TCPA, direction, distance. |
| Filters | Distance only (initial setting value 20NM) |
| Select target | Available |
| Select a Dangerous ship targets | No CPA/TCPA decision |
| 2) Operation | Built-in |
| 3) Installation | NMEA1~3 available |

12.6.4 TT FUNCTION (STANDARD BUILT IN)

- | | |
|------------------------|---|
| 1) Acquisition | MANUAL, AUTO (by guard zone) |
| 2) Tracking | 10 targets (Automatic tracking) |
| 3) Display | |
| Tracking data | 1 ship (AIS or TT) |
| Maximum tracking range | 20NM (This varies depending on the range) |
| Target information | Displays items are true bearing, distance, true course, and true speed. |
| Display of Vectors | True/Relative |
| 4) Operation | Built-in |

12.7 INPUT/ OUTPUT SIGNAL

12.7.1 INPUT ENABLE SIGNAL

- (1) Navigation equipment IEC61162-1/2(※1)
- | | |
|-------------|------------------------------|
| L/L: | GGA>RMC>RMA>GNS>GLL |
| SOG/COG: | RMC>RMA>VTG |
| Log speed: | VBW>VHW |
| HEADING: | THS>HDT>HDG>HDM |
| DEPTH: | DPT>DBT |
| WATER TEMP: | MTW |
| ROT: | ROT (Unsupported on display) |
| RUDDER: | RSA (Unsupported on display) |
| AIS: | VDM, VDO, ALR |
| WIND: | MWV>VWT, VWR |
| WAYPOINT: | RMB>BWC>BWR |
- (2) Bearing signal JRC-NSK format (JLR-10/20/30)(by NMEA3 port)
IEC61162-1/2(※1) 4800bps/38400bps: THS>HDT>HDG>HDM
- (3) Speed signal IEC61162 4800bps: VBW, VHW
※1:IEC61162-2 Conformity is unnecessary.
(Insulation is unnecessary. Input electrical tests are unnecessary.)

12.7.2 OUTPUT POSSIBLE SIGNAL

(1) Navigation equipment

Radar data: RSD

Own ship's data: OSD

TT data: TTM, TTL, TTD

Latitude/ Longitude data: GGA, RMC, GNS, GLL,

COG/SOG: RMC, VTG (Received GPS data)

Bearing signal: THS, HDT (Received GPS Compass data)

(2) External Buzzer Open collector contacts one port. (NMEA cable option necessary)

(3) Output RGB signal To incorporate optional kit (NQA-2447) is necessary

✗In this case, water and dust proofing (IP55) of rear side of display unit is not guaranteed

(4) Slave display output no function

(5) LAN no function

12.7.3 STANDARD CONFIGURATION

Scanner: 1unit

Display Unit: 1unit

Sun cover: 1unit

Installation cable: 1pc. (10m)

Power cable: 1pc. (2m)

Appended parts: 2pcs. (fuse)

Instruction manual: 1 book (Including Installation manual and Quick manual)

12.7.4 OPTION CABLE

Installation cable:

Cable length	Cable type
5m	CFQ9924-5
15m	CFQ9924-15
20m	CFQ9924-20
30m	CFQ9924-30

NMEA cable (waterproof (IPX5)):

Cable length	Cable type
1m	H-7ZCRD1689

APPENDIX

NKE-1066 (1.5FT) SCANNER INTERCONNECTION DIAGRAM

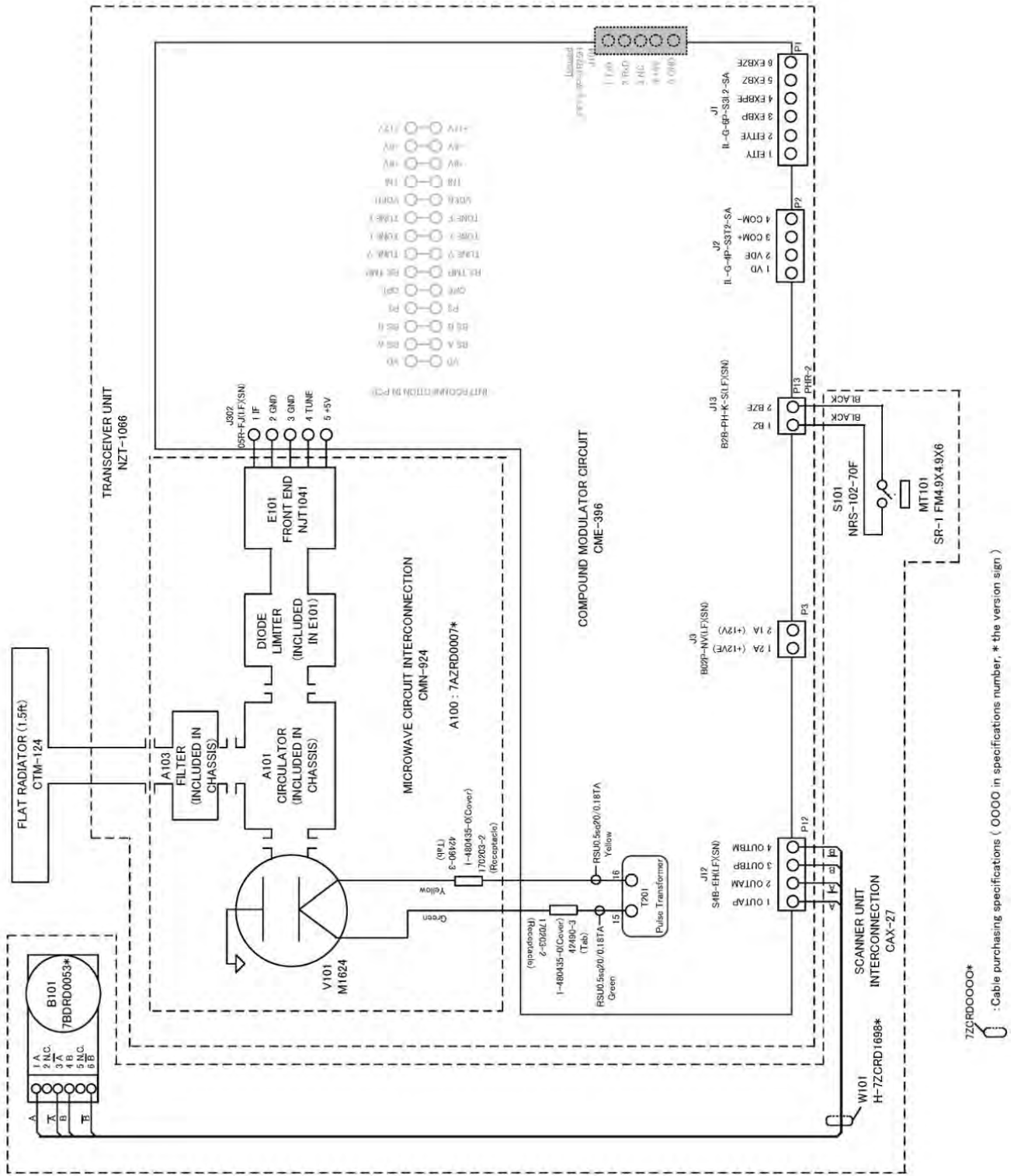

FIG A1

NKE-2044 (2FT) SCANNER INTERCONNECTION DIAGRAM

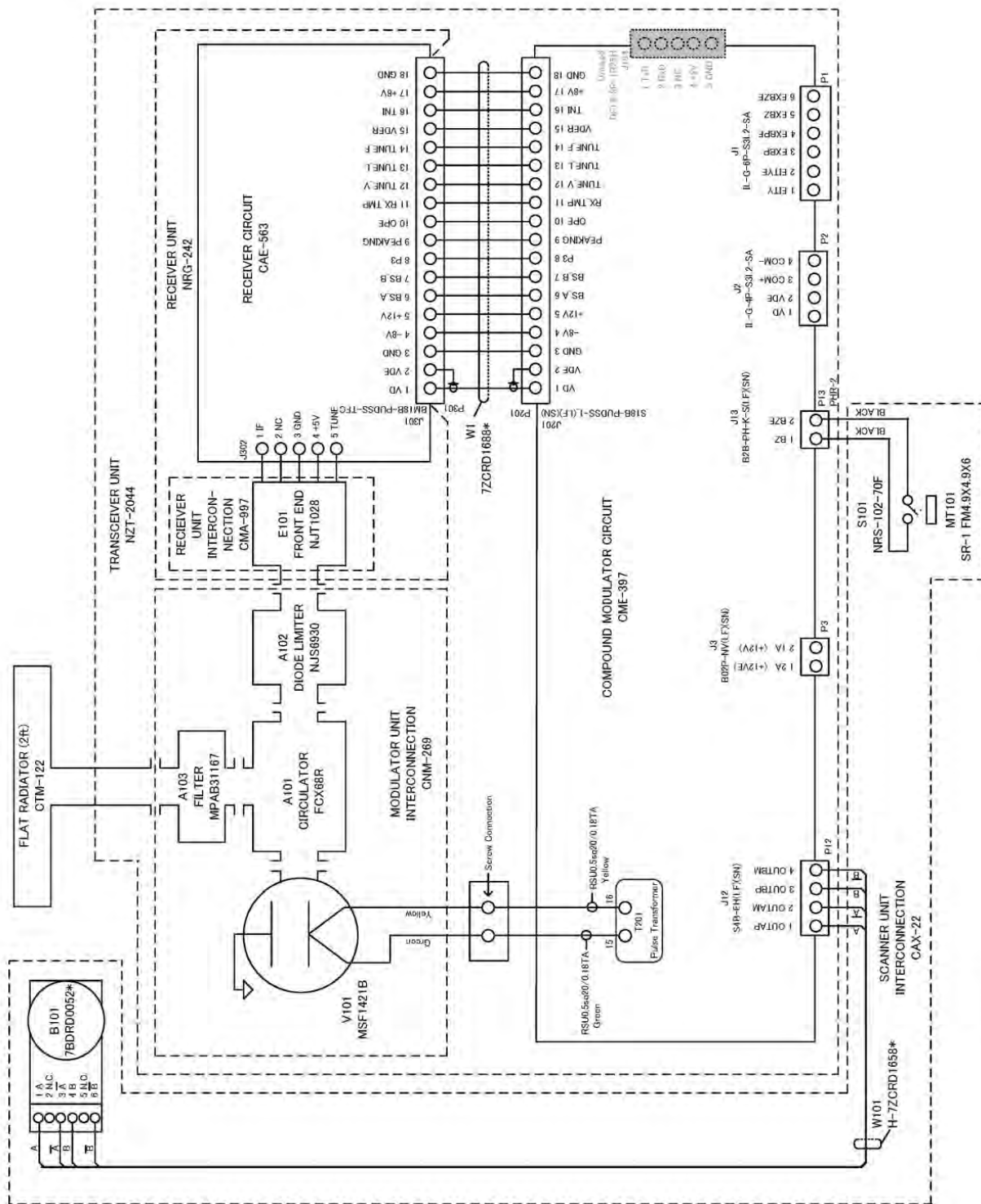

FIG A2

NCD-2256 DISPLAY UNIT INTER CONNECTION DIAGRAM

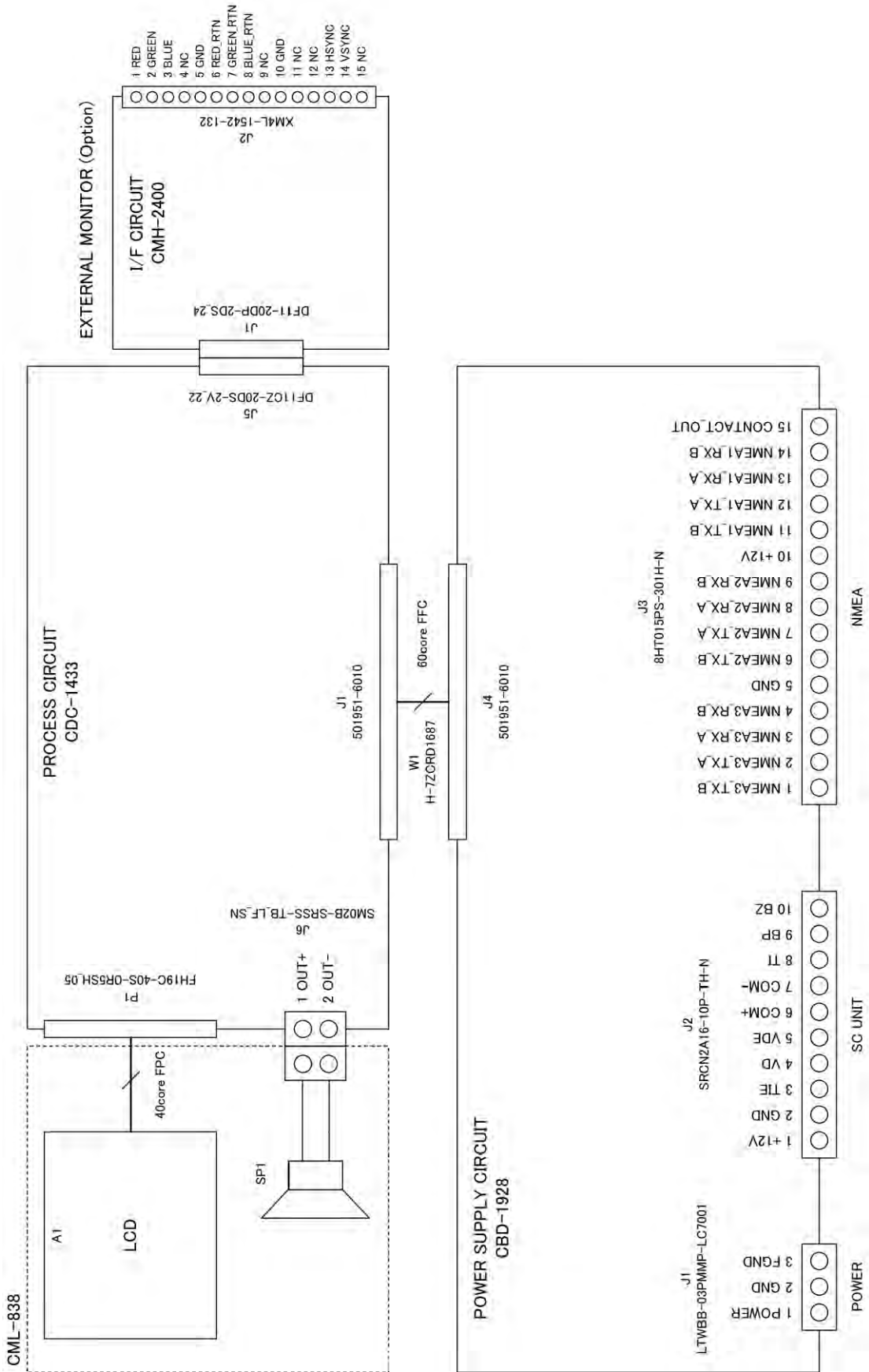

FIG A3

JMA-1030 PRIMARY POWER SUPPLY DIAGRAM

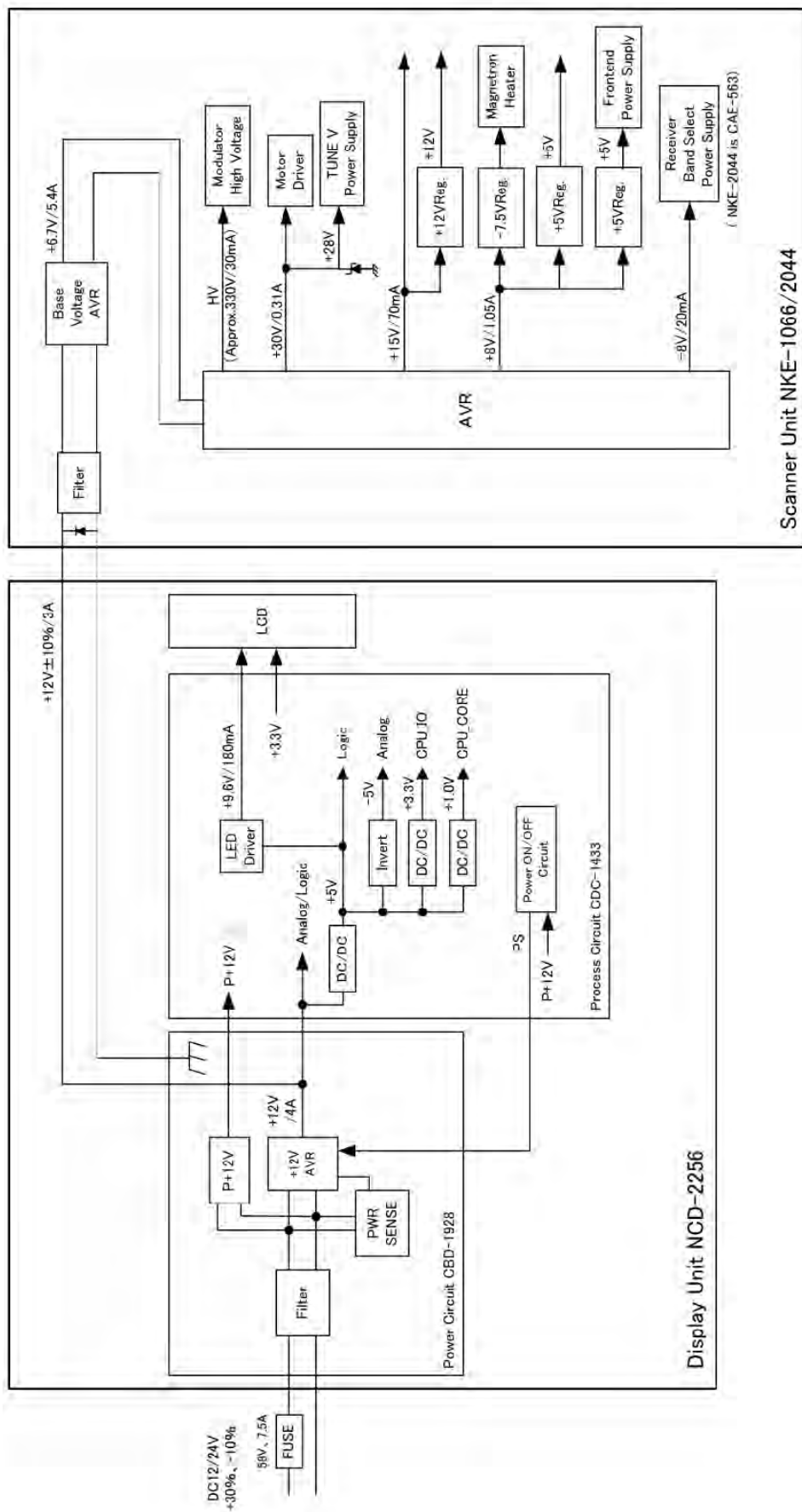

FIG A4

JMA-1030 INTERCONNECTION DIAGRAM

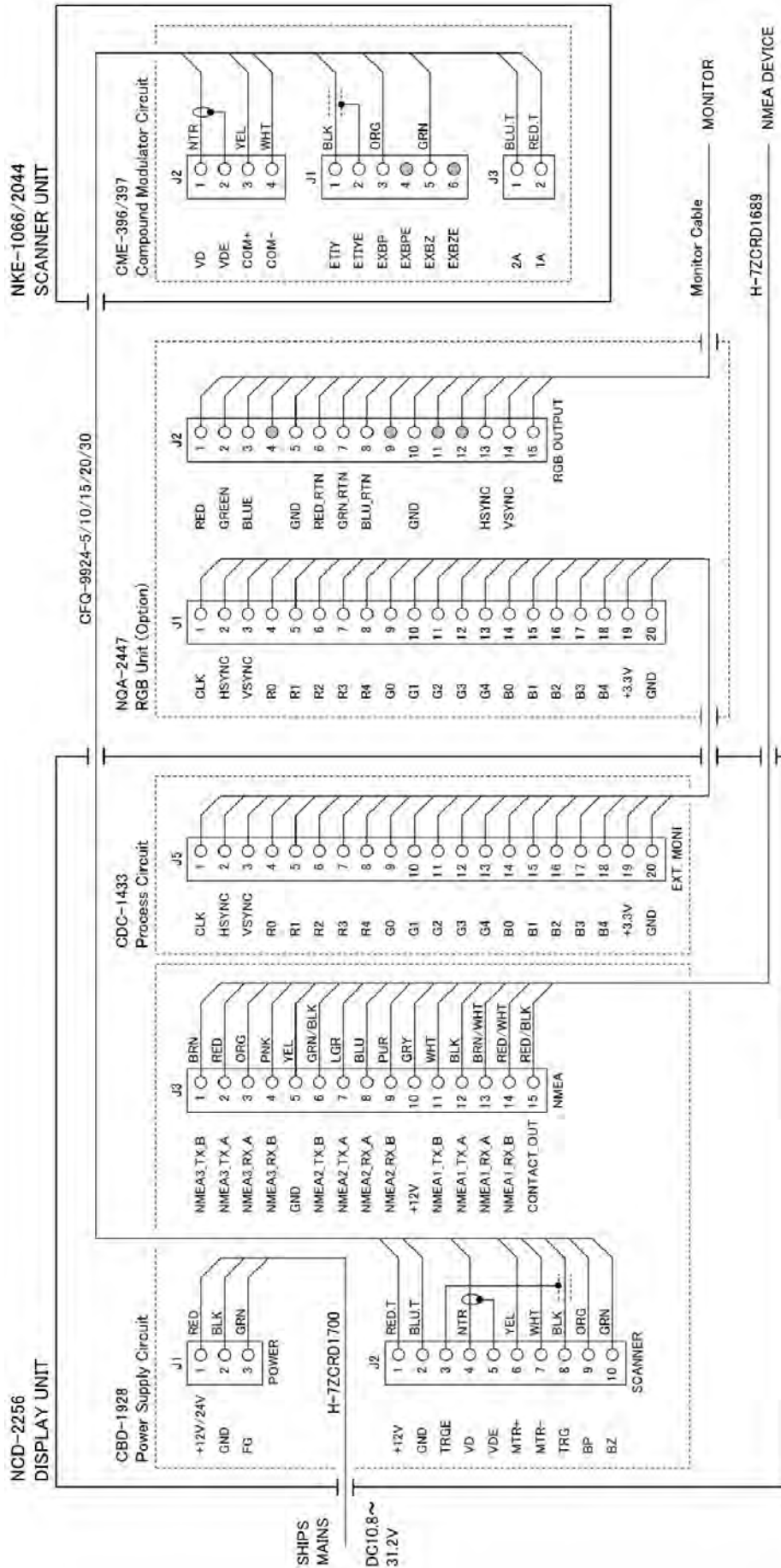

FIG A5

(MEMO)

OPERATION SHEET

Sheet size: 90mm x 140mm

The following sheets are sized to paste the back of the sun cover.

Please cut along the dotted line and use the operation sheet.



At first please display icon menu
 1 line icon menu : flick up onto the display panel
 All icon menu : after the 1 line icon menu display, flick up onto the display panel

-  **TX (transmission), ST-BY (standby)**
Whenever it carries out a tap, transmission and ST-BY are changed.
-  **SEA (sea-clutter rejection) adjustment:**
Control the sea clutter level near the ship.
Long distant echo gain is remaining as it is, and gain is lowered as to short distance.
Adjust the target ship is clearly observe and reject the sea clutter on screen as much as possible.
-  **RAIN (rain-and-snow-clutter rejection) adjustment:**
This type radar uses (X) band microwave (wavelength: 3cm).
This microwave can detectable more far range in fine weather, but in rain or snow weather, the detectable range decrease remarkably.
The control is adjusted for separate the target and rain or snow as long as possible.
-  **GAIN (gain control) adjustment:**
Set up the sensitivity of Radar echo..
-  **VRM (variable range marker)**
Measure the target distance by using circle line.
-  **EBL (electronic bearing line)**
Measure the target direction by using cursor line.

When the brightness is dark
 • Turning while pressing the rotary knob

When you want to erase the EBL, VRM, Cursor
 • Double tap of icon, or Double click the rotary knob at onto selected icon.

PWR/CLR
Power on / off: push and hold 3 seconds

						
GAIN	RAIN	SEA	BRILLIANCE	TX-STBY	RANGE	EBL
						
VRM	GURDZONE	MARK	AIS ACTIV	AIS SLEEP	TT ACTIV	TT ST-BY
						
CURSOR	SETTING	MENU	USER1	USER2	MODE OFF	MODE STD
						
MODE COAST	MODE RIVER	MODE FLOAT	OFF CENTER	MOB	DAY	NIGHT

FIG A6

MENU FUNCTION LIST

Main Menu

Item	Setting Contents
1. RADAR Echo	
1. Pulse Length	SP / MP / LP
2. IR	OFF / Low / Middle / High
3. Target Enhance	OFF / Level1 / Level2 / Level3
4. Process	OFF / 3Scan COREL / 4Scan COREL / 5Scan COREL / Remain / Peak Hold
5. Video Latitude	Narrow / Normal / Wide1 / Wide2
6. Video Noise Rejection	OFF / Level1 / Level2 / Level3
7. Timed TX	OFF / ON
2. Tuning	
3. Motion Mode	
1. Motion	RM / TM
2. Bearing Mode	HUP / NUP / CUP
4. Radar Trails	
1. Trails REF Level	Level1 / Level2 / Level3 / Level4
2. Time/All Combine	OFF / ON
3. Trails Mode	True / Relative
4. Trails Interval	Short : OFF/15sec/30sec/1min/2min/3min/ 4min/5min/6min/10min/15min/CONT Middle : OFF/30sec/1min/2min/3min/4min/ 5min/6min/10min/15min/30min/CONT Long : OFF/1min/2min/3min/4min/5min/ 6min/10min/15min/30min/1hour/CONT Super Long : OFF/30min/1hour/2hour/3hour/4hour/ 5hour/6hour/10hour/12hour/24hour/CONT
5. Vector Length	
1. Vector Mode	True / Relative
2. Vector Length	1 - 60min
6. Marker	
1. Marker Mode	True / Relative
2. VRM Unit	NM / km / sm
3. Range Rings(RR)	OFF / ON
7. Target	
1. Function ON/OFF	
1. TT	OFF / ON
2. AIS	OFF / ON
2. CPA Limit	0.1 - 9.9NM
3. TCPA Limit	1 - 99min
4. CPA Ring Display	OFF / ON
5. Target Number Display	
1. TT	OFF / ON
2. AIS	OFF / ON
6. ALR Alarm From AIS	OFF / ON
7. AIS Display Targets	20 / 30 / 40 / 50
8. AIS List Display	OFF / ON
8. NMEA Info. Set	

Initial Setting Menu

Item	Setting Contents
1. Basic Adjustment	
1. Bearing Adjustment	0.0 - 359.9deg
2. Range Adjustment	0 - 999
3. Tune Adjustment	0 - 127
4. Antenna Height	~5m / 5~10m / 10~20m / 20m~
5. Noise Level	0 - 255
6. Language	English/Spanish/Turkish/Indonesian/Thai/Malay/ Vietnamese/Chinese/Japanese/Korean/Russian
2. RADAR Echo	
1. Main Bang Suppression	
1. MBS Level	0 - 255
2. MBS Area	0 - 255
2. Target Enhance Level	Level1 / Level2 / Level3 / Level4
3. Gain Preset	0 - 255
4. STC	
1. STC Curve Select	Sea / River
2. STC Slope Correction	0.0 - 2.0
3. STC Offset	0 - FF
5. FTC	
1. FTC Curve Select	Sea / River
2. FTC Slope Correction	0.0 - 2.0
3. FTC Offset	0 - FF
6. RADAR Alarm	
1. RADAR Alarm1 Level	Level1 / Level2 / Level3 / Level4
2. RADAR Alarm2 Level	Level1 / Level2 / Level3 / Level4
3. RADAR Trails	
1. MAX Interval	Short / Middle / Long / Super Long
2. Suppression Distance	0 - 1000
4. TT	
1. Vector Constant	1 - 8
2. Gate Display	OFF / ON
3. Gate Size	0 - 64
5. Scanner	
1. PRF Fine Tuning	0 - 31
2. Stagger Trigger	OFF / ON
3. Antenna Rotation Speed	
1. SP1	0 - 7
2. SP2	0 - 7
3. SP3	0 - 7
4. MP1	0 - 7
5. MP2	0 - 7
6. LP1	0 - 7
7. LP2 (*NKE-2044(NL) only)	0 - 7
4. PRF Mode	Normal / Economy / High Power
5. Timed TX	
1. TX Time	1 - 99min
2. STBY Time	1 - 99min
3. Adaptation	ON / OFF
6. Tune Peak Adjustment	0 - 127
7. Tune Indicator Level	0 - 127
6. I/F Device	
1. Heading Equipment	AUTO / GYRO / Compass / GPS / Manual
2. Manual Heading	0.0 - 359.9deg
3. Speed Equipment	GPS / Log / 2axis Log / Manual
4. Manual Speed	0.0 - 100.0kn
5. MAG Compass Setting	
1. Heading Correction	OFF / ON
2. Correct Value	W9.9° - E9.9°
7. COM Port Setting	
1. Baud Rate	
1. NMEA1	AUTO / 4800bps / 38400bps

Item	Setting Contents
2. NMEA2	AUTO / 4800bps / 38400bps
3. NMEA3	AUTO / 4800bps / 38400bps
2. RX Port	
1. GPS	AUTO / NMEA1 / NMEA2 / NMEA3
2. Log	AUTO / NMEA1 / NMEA2 / NMEA3
3. 2axis Log	AUTO / NMEA1 / NMEA2 / NMEA3
4. Depth	AUTO / NMEA1 / NMEA2 / NMEA3
5. Temperature	AUTO / NMEA1 / NMEA2 / NMEA3
6. Wind	AUTO / NMEA1 / NMEA2 / NMEA3
7. WPT	AUTO / NMEA1 / NMEA2 / NMEA3
8. Rate of Turn	AUTO / NMEA1 / NMEA2 / NMEA3
9. Rudder	AUTO / NMEA1 / NMEA2 / NMEA3
3. TX Port	
1. TTM	OFF / NMEA1 / NMEA2 / NMEA3
2. TLL	OFF / NMEA1 / NMEA2 / NMEA3
3. TTD	OFF / NMEA1 / NMEA2 / NMEA3
4. TLB	OFF / NMEA1 / NMEA2 / NMEA3
5. GGA	OFF / NMEA1 / NMEA2 / NMEA3
6. GLL	OFF / NMEA1 / NMEA2 / NMEA3
7. RMC	OFF / NMEA1 / NMEA2 / NMEA3
8. GNS	OFF / NMEA1 / NMEA2 / NMEA3
9. VTG	OFF / NMEA1 / NMEA2 / NMEA3
10. THS	OFF / NMEA1 / NMEA2 / NMEA3
11. HDT	OFF / NMEA1 / NMEA2 / NMEA3
12. OSD	OFF / NMEA1 / NMEA2 / NMEA3
13. RSD	OFF / NMEA1 / NMEA2 / NMEA3
4. TX Data Format	
1. TX Interval	1 - 9sec
2. NMEA Version	V1.5 / V2.0 / V2.3
3. NMEA Talker	Normal / GP
5. Target Info. TX	
1. TX Target	TT / AIS / TT-AIS
2. TTM Range Accuracy	1 / 2 / 3
3. TT Average Mode	OFF / ON
4. TT Average Scan	2 - 10
8. JRC GPS	
1. GPS Status	
2. GPS Setting	
1. NMEA Version	AUTO / V1.5 / V2.0 / V2.3
2. Correction Method	GPS Single / SBAS / Beacon / AUTO
3. Fix Mode	2D / 3D / AUTO
4. Elevate Mask	5 - 89°
5. HDOP	4 / 10 / 20
6. Smoothing LL	0 - 99sec
7. Smoothing SOG	0 - 99sec
8. Smoothing COG	0 - 99sec
9. Smoothing	0 - 99sec (R29.04 - R33.99) 1 - 99sec (R26.01 - R29.03)
10. Smoothing	0sec / 10sec / 40sec
11. RAIM Accuracy Level	OFF / 10m / 30m / 50m / 100m
12. Exclusion Satellite	
1. Exclusion Satellite1	0 - 32
2. Exclusion Satellite2	0 - 32
3. Exclusion Satellite3	0 - 32
4. Exclusion Satellite4	0 - 32
5. Exclusion Satellite5	0 - 32
6. Exclusion Satellite6	0 - 32
13. Send Data	
14. GPS Adjust	
1. Position	
2. Antenna Height	0 - 8191m
3. Time	00:00:00 - 23:59:59
4. Date	2013/1/1/ - 2099/12/31

Item	Setting Contents
5. Master Reset	
6. Send Data	
3. Beacon Setting	
1. Station Select	AUTO / Manual
2. Frequency	283.5 - 325.0kHz
3. Baud Rate	50bps / 100 bps / 200bps
4. Send Data	
4. SBAS Setting	
1. Satellite Search	AUTO / Manual
2. Ranging	OFF / ON
3. SBAS Satellite Number	120 - 138
4. Send Data	
9. Control	
1. Touch Panel Calibration	
2. Buzzer	
1. Key ACK	OFF / 1 - 5
2. Operation Error	OFF / 1 - 5
3. CPA/TCPA	OFF / 1 - 5
4. AZ/Alarm Zone	OFF / 1 - 5
5. Target Lost	OFF / 1 - 5
6. System Alarm	OFF / 1 - 5
10. Maintenance	
1. Partial Reset	
1. All Menu	
2. RADAR Echo	
3. Initial Setting Menu	
4. Main Menu	
2. All Reset	
3. System Time Clear	
4. Scanner Time Clear	
1. TX Time Clear	
2. Motor Time Clear	
3. ANT to DISP Unit	
4. DISP to ANT Unit	
5. Table Update	
1. Initial Value	
1. All Menu	
2. RADAR Echo	
3. Initial Setting Menu	
4. Main Menu	
2. Insert Language	
3. STC Curve	
6. Internal Setting	
1. Internal Memory to USB	
1. All Menu	
2. RADAR Echo	
3. Initial Setting Menu	
4. Main Menu	
5. Mark Setting	
2. USB to Internal Memory	
1. All Menu	
2. RADAR Echo	
3. Initial Setting Menu	
4. Main Menu	
5. Mark Setting	
7. USB Format	
11. System Setting	
1. Master/Slave/DEMO	Master / Slave / Demo
2. Own Ship Outline	
1. All Length	0.0 - 600.0m
2. All Width	0.0 - 200.0m
3. Scanner (from Bow)	0.0 - 600.0m

Item	Setting Contents
4. Scanner (from Cntr.)	-100.0 – 100.0m
3. Unit	
1. Range	NM / km / sm
2. Distance	NM / km / sm
3. Speed	kn / km/h / mph
4. Depth	ft / fm / m / user
5. User Depth	0.1 - 10.0
6. Temperature	°C / °F
7. Wind	m/s / km/h / kn / Bft.
4. Move Own Ship	
1. Ship's Move Method	LL / COG/SOG
5. Range	
1. NM	
1. 0.0625NM	OFF / ON
2. 0.125NM	OFF / ON
3. 0.25NM	OFF / ON
4. 1NM	OFF / ON
5. 2NM	OFF / ON
6. 4NM	OFF / ON
7. 8NM	OFF / ON
8. 16NM	OFF / ON
9. 24NM	OFF / ON
10. 32NM (*NKE-2044(NL) only)	OFF / ON
11. 48NM (*NKE-2044(NL) only)	OFF / ON
2. km	
1. 0.15km	OFF / ON
2. 0.3km	OFF / ON
4. 1.2km	OFF / ON
5. 2km	OFF / ON
6. 8km	OFF / ON
7. 16km	OFF / ON
8. 32km	OFF / ON
3. sm	
1. 0.0625sm	OFF / ON
2. 0.125sm	OFF / ON
3. 0.25sm	OFF / ON
4. 1sm	OFF / ON
5. 2sm	OFF / ON
6. 4sm	OFF / ON
7. 8sm	OFF / ON
8. 16sm	OFF / ON
9. 24sm	OFF / ON
10. 32sm (*NKE-2044(NL) only)	OFF / ON
11. 48sm (*NKE-2044(NL) only)	OFF / ON
12. Display Screen	
1. Own Vector Display	OFF / ON
2. STBY Disp. Select	Normal / Graphical / Numeric
3. Operation Num Disp.	OFF / ON
4. Display Color	
1. PPI	
1. Color	Black / Blue / White
2. Brilliance	Level1 / Level2 / Level3 / Level4
2. Character	
1. Color	White / Cyan / Green / Black / Red / Gold / Amber
2. Brilliance	Level1/ Level2/ Level3/ Level4
3. RADAR Echo	
1. Color	Yellow / Green / Blue / White / Magenta / Gold / Amber / Color
2. Brilliance	Level1 / Level2 / Level3 / Level4
4. RADAR Trails (Time)	
1. Color	Green / Blue / Cyan
2. Brilliance	Level1 / Level2 / Level3 / Level4
5. RADAR Trails (All)	

Item	Setting Contents
1. Color	Green / Blue / Cyan
2. Brilliance	Level1 / Level2 / Level3 / Level4
6. Own Ship's	
1. Color	Cyan / Green / Red / White / Gold / Amber
2. Brilliance	Level1 / Level2 / Level3 / Level4
7. Target (TT/AIS)	
1. Color	Cyan / Green / White
2. Brilliance	Level1 / Level2 / Level3 / Level4
8. EBL/VRM	
1. Color	Cyan / Black / Magenta / White
2. Brilliance	Level1 / Level2 / Level3 / Level4
9. Range Ring	
1. Color	Cyan / Green / Red / White / Gold / Amber
2. Brilliance	Level1 / Level2 / Level3 / Level4
10. Cursor	
1. Color	White / Red / Magenta / Yellow
2. Brilliance	Level1 / Level2 / Level3 / Level4
11. AZ/Alarm Zone	
1. Color	White / Green / Orange / Black / Red
2. Brilliance	Level1 / Level2 / Level3 / Level4
5. Waypoint Display	ON / OFF
6. AIS Filter	0.0 - 48.0NM
13. Error Alarm Mask	
1. Scanner	
1. Scanner(Time Out)	
1. Alarm Sensitivity	OFF / ON
2. Sensitivity Time	0 - 999sec
2. Scanner(Data)	
1. Alarm Sensitivity	OFF / ON
2. Sensitivity Time	0 - 999sec
3. Scanner(Video)	
1. Alarm Sensitivity	OFF / ON
2. Sensitivity Time	0 - 999sec
4. Scanner (Trigger)	
1. Alarm Sensitivity	OFF / ON
2. Sensitivity Time	0 - 999sec
5. Scanner(AZI)	
1. Alarm Sensitivity	OFF / ON
2. Sensitivity Time	0 - 999sec
6. Scanner(HL)	
1. Alarm Sensitivity	OFF / ON
2. Sensitivity Time	0 - 999sec
7. Scanner(MHV)	
1. Alarm Sensitivity	OFF / ON
2. Sensitivity Time	0 - 999sec
8. Scanner(Heater)	
1. Alarm Sensitivity	OFF / ON
2. Sensitivity Time	0 - 999sec
2. Display Unit	
1. Display Unit(Video)	
1. Alarm Sensitivity	OFF / ON
2. Sensitivity Time	0 - 999sec
2. Display Unit(Trigger)	
1. Alarm Sensitivity	OFF / ON
2. Sensitivity Time	0 - 999sec
3. Display Unit(AZI)	
1. Alarm Sensitivity	OFF / ON
2. Sensitivity Time	0 - 999sec
4. Display Unit(HL)	
1. Alarm Sensitivity	OFF / ON
2. Sensitivity Time	0 - 999sec
5. Display Unit(DSP)	

Item	Setting Contents
1. Alarm Sensitivity	OFF / ON
2. Sensitivity Time	0 - 999sec
6. COM Port	
1. Alarm Sensitivity	OFF / ON
3. RX Data	
1. GYRO	
1. Alarm Sensitivity	OFF / ON
2. Sensitivity Time	0 - 999sec
2. Compass	
1. Alarm Sensitivity	OFF / ON
2. Sensitivity Time	0 - 999sec
3. Log	
1. Alarm Sensitivity	OFF / ON
2. Sensitivity Time	0 - 999sec
4. 2Axis Log	
1. Alarm Sensitivity	OFF / ON
2. Sensitivity Time	0 - 999sec
5. Course/Speed	
1. Alarm Sensitivity	OFF / ON
2. Sensitivity Time	0 - 999sec
6. Depth	
1. Alarm Sensitivity	OFF / ON
2. Sensitivity Time	0 - 999sec
7. Temperature	
1. Alarm Sensitivity	OFF / ON
2. Sensitivity Time	0 - 999sec
8. Wind	
1. Alarm Sensitivity	OFF / ON
2. Sensitivity Time	0 - 999sec
9. Rate of Turn	
1. Alarm Sensitivity	OFF / ON
2. Sensitivity Time	0 - 999sec
10. Rudder	
1. Alarm Sensitivity	OFF / ON
2. Sensitivity Time	0 - 999sec
11. WPT	
1. Alarm Sensitivity	OFF / ON
2. Sensitivity Time	0 - 999sec
12. LAT/LON	
1. Alarm Sensitivity	OFF / ON
2. Sensitivity Time	0 - 999sec
13. Datum	
1. Alarm Sensitivity	OFF / ON
2. Sensitivity Time	0 - 999sec
14. Status	
1. Alarm Sensitivity	OFF / ON
2. Sensitivity Time	0 - 999sec
15. HDOP	
1. Alarm Sensitivity	OFF / ON
2. Sensitivity Time	0 - 999sec
16. AIS	
1. Alarm Sensitivity	OFF / ON
2. Sensitivity Time	0 - 999sec
14. Test	
1. System Information	
2. System Time	
1. Scanner Transmit Time	
2. Scanner Motor Time	
3. Scanner Running Time	
4. Indicator Running Time	
3. Scanner Information	
1. Scanner Transmit Power	

Item	Setting Contents
2. Motor Type	
3. Magnetron Current	
4. Hardware Information	
1. Serial Number	
5. Error Log	
1. View	
2. Erase	
6. Line Monitor	
1. Scanner	
2. NMEA1	
3. NMEA2	
4. NMEA3	
7. Self Test	
1. Key Test	
2. Touch Panel Test	
3. Buzzer Test	
4. Key Light Test	
5. Monitor Display Test	
1. Pattern1	
2. Pattern2	
3. Pattern3	
4. Pattern4	
5. Pattern5	
6. Pattern6	
7. Pattern7	
8. RGB Setting	
1. Red	
2. Green	
3. Blue	
4. Display	
6. Memory Test	
1. SDRAM	
2. Flash ROM	
3. USB	
7. Line Test	
1. Scanner	
2. NMEA1 or GPS(JRC)	
3. NMEA2	
4. NMEA3 or NSK	
8. Scanner Test	
1. SSW Off	
2. BP	
3. BZ	
4. Mod.HV	
5. Trigger	
6. Video	

EU DECLARATION OF CONFORMITY

EU Declaration Of Conformity

01) Apparatus Product/Model:

Product: Marine Radar.
Model: JMA-1032

02) Name & Address of the Manufacturer:

Japan Radio Co., Ltd.,
21-11, Mure 6-chome, Mitaka-shi, Tokyo 181-0002 Japan.

03) This declaration of conformity is issued under the sole responsibility of the manufacturer.

04) Object of the declaration – identification of apparatus allowing traceability:

Marine Radar, Japan Radio Co., Ltd manufactured model JMA-1032.

05) The object of the declaration described above is in conformity with the relevant EU harmonization legislation:

Radio Equipment Directive (RED): 2014/53/EU.

06) References to the relevant harmonized standards used, including the date of the standard, or references to other technical specifications, including the date of the specification, in relation to which conformity is declared:

EN60945:2002 (Ed4) - General Requirements for Marine Equipment.
ETSI EN 302 248 (v2.1.1) – Navigation radar for use on non-SOLAS vessels.
IEC61162 series – as applicable.

07) Notified Body involved:

Not applicable.

08) Description of accessories and components, including software:

Software version: NKE-1066 04.02
NCD-2256 01.00

09) Additional Information:

Antenna length 1.5ft, Peak power 4kW(Magnetron), Display 7inch wide with touch panel

Signed for and on behalf of: Japan Radio Co., Ltd., Tokyo, Japan.

Place and date of issue:

Nagano-shi, Nagano ,Japan Dated 30th May 2017
Navigation Group
Quality Assurance Department
Marine Systems

Name/function: Hiroshi Isohata / Manager

Signed: 
.....

EU Declaration Of Conformity

01) Apparatus Product/Model:

Product: Marine Radar.

Model: JMA-1034

02) Name & Address of the Manufacturer:

Japan Radio Co., Ltd.,

21-11, Mure 6-chome, Mitaka-shi, Tokyo 181-0002 Japan.

03) This declaration of conformity is issued under the sole responsibility of the manufacturer.

04) Object of the declaration – identification of apparatus allowing traceability:

Marine Radar, Japan Radio Co., Ltd manufactured model JMA-1034.

05) The object of the declaration described above is in conformity with the relevant EU harmonization legislation:

Radio Equipment Directive (RED): 2014/53/EU.

06) References to the relevant harmonized standards used, including the date of the standard, or references to other technical specifications, including the date of the specification, in relation to which conformity is declared:

EN60945:2002 (Ed4) - General Requirements for Marine Equipment.

ETSI EN 302 248 (v2.1.1) – Navigation radar for use on non-SOLAS vessels.

IEC61162 series – as applicable.

07) Notified Body involved:

Not applicable.

08) Description of accessories and components, including software:

Software version: NKE-2044 04.02

NCD-2256 01.00

09) Additional Information:

Antenna length 2ft, Peak power 4kW(Magnetron), Display 7inch wide with touch panel

Signed for and on behalf of: Japan Radio Co., Ltd., Tokyo, Japan.

Place and date of issue:

Nagano-shi, Nagano ,Japan Dated 30th May 2017

Navigation Group

Quality Assurance Department

Marine Systems

Name/function: Hiroshi Isohata / Manager

Signed:



Code: 7ZPRD0970

アスベストは使用しておりません
Not use the asbestos

For further information, contact:

JRC *Japan Radio Co., Ltd.*

Since 1915

URL Head office : <http://www.jrc.co.jp/eng/>

Marine Service Department

1-7-32 Tatsumi, Koto-ku, Tokyo 135-0053, Japan

e-mail : tmsc@jrc.co.jp

One-call : +81-50-3786-9201

ISO 9001, ISO 14001 Certified

CODE No.7ZPRD0895

JUL. 2017 Edition 4